

DURANTE A EXPOLONDRINA

LEILÃO
SUPER
NELORE
VIRTUAL

6ª EDIÇÃO

2024
10/04
19 HORAS
Quarta-feira

PARTICIPANTES:



FAZENDA
NOVA PANAPANEMA
60 ANOS DE SELEÇÃO



NELORE
VALE DA CEGONHA



WP
Santa Fé



neLoreabra
EXCELÊNCIA GENÉTICA



50 REPRODUTORES
100% AVALIADOS
TODOS COM REGISTRO
DEFINITIVO



LEILOEIRA



PATROCÍNIO



TRANSMISSÃO



RETRANSMISSÃO



ASSESSORIA



INFORMAÇÕES ☎ (18) 3608.0999 ☎ (18) 99637.2999

#SIGA-NOS @ /CentralLeiloes f /centralleiloes

REGULAMENTO DO LEILÃO

O presente regulamento estabelecerá as normas que serão observadas durante o leilão, sendo que seu cumprimento será obrigatório a todos aqueles que, na condição de convidados, participantes e/ou promotores do evento, quiserem promover a aquisição ou venda de animal(is) ou produto(s) agrobusiness, ou como mero espectador.

1. DEFINIÇÕES

1.1 Considera-se LEILÃO o evento que visa a comercialização de animal(is) e/ou produto(s), pela melhor oferta de valores, efetuada de forma aberta e aceita por um leiloeiro.

1.2 Considera-se EMPRESA LEILOEIRA a empresa responsável pela organização e coordenação do leilão. O presente leilão será coordenado e organizado pela Central Leiloes Ltda.

1.3 Considera-se LEILOEIRO a pessoa inscrita no Sindicato Nacional dos Leiloeiros Rurais, detentor de fé-pública, e que será responsável pela recepção das propostas de ofertas aos lotes comercializados, bem como pela batida do martelo e concretização do negócio.

1.4 Considera-se PROMOTOR DO EVENTO a(s) pessoa(s), física(s) ou jurídica(s), que for(em) responsável(is) pela promoção do evento e arrematação do(s) animal(is) ou produto(s) para serem comercializados no leilão.

1.5 Considera-se CONVIDADO a pessoa, física ou jurídica, que for proprietária de animal(is) ou produto(s) que será(ao) comercializado(s) no leilão. Ao convidado também será permitida a realização de compras no leilão.

1.6 Considera-se PARTICIPANTE todo aquele que comparecer no leilão e que tenha interesse na compra de animal(is) ou produto(s) comercializado(s) no evento, ou como mero espectador.

1.7 Considera-se COMISSÃO DE COMPRA a comissão paga pelo comprador do(s) animal(is) / produto(s) à EMPRESA LEILOEIRA, que será anunciada pelo leiloeiro no início do leilão, cujo percentual incidirá sobre o valor total de cada lote apregado.

1.8 Considera-se COMISSÃO DE VENDA a comissão paga pelo proprietário do(s) animal(is) / produto(s) ao PROMOTOR DO EVENTO / EMPRESA LEILOEIRA.

1.9 Considera-se PRODUTO tudo que não seja semovente e que possa ser comercializado em leilão, tais como: embrião, sêmen, etc.

1.10 Considera-se LANCE DE DEFESA o lance ofertado pelo próprio proprietário do animal(is) ou produto(s), quando não alcançado o preço esperado por este junto ao leilão. Nesta hipótese, o proprietário será responsável pelo pagamento das comissões de compra e venda acima previstas.

1.11 Considera-se LOTE o grupo de animais ou o animal individualmente e/ou de produtos a serem colocados à venda através de leilão, devidamente identificado no catálogo.

2. CADASTRO:

2.1 Todo aquele que pretenda apresentar lance no leilão deverá estar previamente cadastrado junto à Central Leiloes Ltda, podendo encaminhar tal solicitação à empresa leiloeira com antecedência, para fins de análise e aprovação prévia dos cadastros. Nesta hipótese, o pedido de cadastramento importará em autorização automática à empresa leiloeira de consulta de informações do solicitante junto ao SERASA ou outros órgãos de proteção ao crédito.

2.2 A Central Leiloes Ltda disponibilizará aos convidados e participantes um escritório no local do evento, podendo o cadastro ser efetuado neste local. Nesta hipótese, toda compra efetuada pelo convidado ou participante ficará condicionada à posterior aprovação do cadastro, bem como aceitação pelo VENDEDOR.

2.3 A presença dos convidados ou participantes no recinto do leilão importará em imediata autorização à Central Leiloes Ltda em promover consultas sobre os mesmos junto ao SERASA ou outros órgãos de proteção ao crédito.

2.4 Os empregados da Central Leiloes Ltda não estão autorizados a avalizar ou endossar qualquer comprador junto ao leilão.

2.5 A existência de cadastro não dispensará a necessidade de apresentação de avalista, caso seja solicitado pelo VENDEDOR ou pela Central Leiloes Ltda.

2.6 Será permitida a compra de animal(is) / produto(s) mediante procuração por Instrumento Público, a qual deverá ser específica para aquele evento e deverá conter o valor máximo autorizado pelo outorgante e desde que este possua cadastro aprovado junto à Central Leiloes Ltda, que permanecerá com referida procuração.

2.7 A Central Leiloes Ltda atua como intermediária das transações, sendo responsável pela organização e coordenação do evento, não se responsabilizando pelo inadimplemento do comprador, seja em relação ao valor do(s) produto(s) / animal(is) adquirido(s), seja em relação às comissões de venda. Portanto, cabe ao vendedor manifestar-se sobre o cadastro do comprador antes da assinatura do contrato de compra e venda, bem como exigir a assinatura de avalista antes da formalização deste contrato.

3. DO LEILOEIRO:

3.1 O leilão será realizado por um LEILOEIRO RURAL, devidamente inscrito nos órgãos próprios, sendo que a venda considerará efetuada com a batida do martelo, momento em que as partes, compradores e vendedores, estarão obrigados ao cumprimento do negócio fechado, exceto na hipótese de não aprovação do cadastro do comprador, na forma do item 02 supra.

3.2 Poderá o leiloeiro, durante o leilão, promover as alterações das presentes normas, estabelecer outras regras, alterar as disposições do catálogo, de lotes ou condições de pagamento, instituir preços mínimos, sem direito de reclamação ou indenização por parte dos convidados ou participantes.

4. DISPOSIÇÕES ESPECÍFICAS PARA LEILÃO DE PRENHEZES:

4.1 Salvo estipulação em contrário, nos casos de livre acasalamento ou embrião a ser coletado, a primeira parcela será considerada como sinal de negócio e devidas no ato. As demais parcelas somente poderão ser exigidas do(s) COMPRADOR(es) após o recebimento ou a retirada da(s) prenhez(es) confirmada(s). Caso o VENDEDOR tenha recebido antecipadamente alguma parcela e a prenhez não consiga se realizar o VENDEDOR restituirá ao(s) COMPRADOR(es) o valor recebido.

4.2. PRENHEZES RECEPTORAS:

4.2.1. O VENDEDOR se responsabiliza em apresentar a(s) receptora(s) em perfeitas condições físicas, com boa habilidade maternal, a fim de bem criar o embrião.

4.2.2. O COMPRADOR, por sua vez, se compromete a mantê-la(s) sob as mesmas condições de manejo e trato, a fim de não prejudicar o desenvolvimento do embrião adquirido.

4.2.3. O COMPRADOR deverá comunicar imediatamente o VENDEDOR em caso de óbito da receptora e/ou da "cria", bem como de qualquer intercorrência que venha a surgir durante o período gestacional.

4.3. EMBRIÕES A SEREM COLETADOS:

4.3.1. É de responsabilidade de VENDEDOR a coleta e transferência do referido acasalamento, tendo o prazo máximo de 90 dias para a entrega da receptora prenhe, a contar da data da assinatura do presente Contrato, findo o qual poderá o COMPRADOR optar, em comum acordo com o VENDEDOR, escolher outro acasalamento já realizado, de igual importância e valor.

4.4. LIVRES ACASALAMENTOS:

4.4.1. O VENDEDOR oferece a doadora para ser acasalada com o touro da escolha do COMPRADOR, ficando a mesma na propriedade do titular.

4.4.2. O COMPRADOR tem o prazo máximo de 30 dias para enviar o sêmen do reprodutor escolhido, ou autorizar o proprietário da doadora a acasalá-la segundo seu critério.

4.4.3. Todas as despesas provenientes do transporte e aquisição de sêmen que porventura possam ocorrer, serão de inteira responsabilidade do COMPRADOR.

4.4.4. Do acasalamento em questão o COMPRADOR terá direito a apenas uma prenhez proveniente da lavagem, salvo disposição em contrário e acordado entre as partes. Terá também direito a optar se tal prenhez será sexada de macho ou fêmea.

4.4.5. O VENDEDOR garante ao COMPRADOR que a prenhez adquirida venha a nascer com saúde, com garantia de receber RGN (registro geral de nascimento) e RGD (registro geral definitivo).

4.4.6. Caso o produto nascido não preencha os requisitos mencionados no item anterior, deverá o VENDEDOR substituir o produto, caso não possua o mesmo acasalamento, de comum acordo com o COMPRADOR, substituí-lo por outro já nascido de igual categoria e valor.

4.5 A(s) prenhez(es) será(ão) entregue(s) por malha viária, podendo ainda o COMPRADOR retirá-la da propriedade de origem, sob sua conta e responsabilidade.

CONTINUAÇÃO DA PÁGINA ANTERIOR...

5. DISPOSIÇÕES ESPECÍFICAS PARA LEILÃO DE SÊMEN:

5.1. O VENDEDOR responde pela qualidade do sêmen de animal de sua propriedade posto a venda.

5.2. Todo lote de sêmen deverá estar à disposição do COMPRADOR para ser retirado em local previamente estipulado. Nos casos em que a entrega do sêmen for feita por empresa de coleta, as despesas decorrentes deste procedimento correrão por conta e risco COMPRADOR. Quando o sêmen de animal, comercializado for do estoque particular do VENDEDOR, o COMPRADOR deverá providenciar botijão para o transporte, correndo por conta deste todo e qualquer risco.

5.3. Caso queira, poderá o COMPRADOR, no ato da retirada, testar a qualidade do sêmen adquirido, em sendo este raro, desde que seja realizado por profissionais credenciados por uma das centrais de coleta do país.

6. DISPOSIÇÕES GERAIS PARA TODOS OS LEILÕES:

6.1. O leiloeiro apregoará, no início de cada lote, o valor do lance que, multiplicado pelo número de parcelas determinadas, formará o preço total de venda e compra do(s) animal(is)/ produto(s). Também será informada a condição de cada venda, data de vencimento das parcelas, condições gerais do(s) produto(s) ou a(s) condição(ões) física(s) do(s) animal(is) referentes a cada lote.

6.2. Os leilões referentes à gado de elite, embrião e sêmen serão realizados com CLÁUSULA DE RESERVA DE DOMÍNIO, que abrangerá inclusive as "crias" advindas destes, conforme disposto no artigo 95 do Código Civil.

6.3. Excetuando o disposto no item 2. deste Regulamento (aprovação de cadastro), as vendas efetuadas durante o leilão são irrevogáveis e irrevogáveis, obrigando comprador e vendedor ao seu cumprimento, por si e por seus herdeiros ou sucessores.

6.4. Ainda que existente índice deflacionário divulgado pelo Governo Federal, os preços estabelecidos no leilão não serão alterados.

6.5. Caberá ao comprador o pagamento do ICMS e ao vendedor o recolhimento do mesmo, referente ao lote adquirido, devendo o segundo informar a Central Leilões Ltda o número de inscrição junto à Receita Estadual.

6.6. A participação no leilão de qualquer pessoa, seja comprador ou vendedor, implicará na presunção de aceitação de todas as normas previstas neste Regulamento, e, face disponibilização deste Regulamento a todos que se encontram presentes no recinto do leilão através do catálogo, não poderá alegar desconhecimento para eximir de seu cumprimento.

6.7. Compradores domiciliados fora do país deverão informar-se no escritório sobre as condições que regem a compra e venda, que no caso presente somente se operará com o pagamento à vista, em moeda corrente do país, no ato do negócio.

6.8. Salvo estabelecido de forma diversa, por escrito, antes do leilão, o comprador será responsável pelo pagamento da comissão de compra, a qual recai sobre o valor do lote no momento da batida do martelo, em favor da EMPRESA LEILOEIRA, cujo percentual será divulgado pelo leiloeiro no início do evento.

6.9. Salvo estabelecido de forma diversa, por escrito, antes do leilão, o vendedor será responsável pelo pagamento da comissão de venda, a qual recai sobre o valor do lote no momento da batida do martelo, em favor do PROMOTOR DO EVENTO / EMPRESA LEILOEIRA, cujo percentual foi acordado anteriormente entre as partes.

6.10. As taxas do leilão, assim como as comissões, para comprador e vendedor, são irrevogáveis e irrevogáveis. No caso da não concretização do negócio após o remate, a parte responsável pelo cancelamento do negócio arcará com as mesmas em sua totalidade.

6.11. EM caso de pagamento à vista das parcelas de compra, o desconto poderá ser concedido pelo vendedor, mas tal desconto não recairá sobre as comissões em favor da Leiloeira.

6.12. No lance de defesa, conforme definição do item 1.10 deste regulamento, o proprietário do animal será responsável pelo pagamento da comissão de compra e venda em favor do PROMOTOR DO EVENTO / EMPRESA LEILOEIRA, sobre o valor do lote no momento da batida do martelo.

6.13. Não serão aceitos pagamentos das parcelas vencíveis no ato da compra com cheques de terceiros.

6.14. Todos os pagamentos efetuados em cheque somente serão considerados quitados com a respectiva compensação.

6.15. As GTAS (Guias de Trânsito dos Animais) serão emitidas exclusivamente em nome do comprador e não poderão ser transferidas a terceiros.

6.16. Os catálogos do leilão são de responsabilidade dos vendedores, não sendo a Central Leilões Ltda responsável por eventuais erros constantes nestes, os quais inclusive poderão ser retificados pelo leiloeiro.

6.17. Quando da batida do martelo os lances forem simultâneos entre dois compradores, o leiloeiro pedirá o retorno do animal à pista e reiniciará a

venda dos mesmos, a partir do lance em questão, para o desempate.

6.18. Serão de exclusiva responsabilidade do vendedor, o(s) animal(ais) colocado(s) a leilão estar(em) saudável(eis), com toda documentação sanitária atualizada, bem como a sua guarda, manutenção e segurança, durante o tempo em que se mantiver(em) no local do leilão, seja no estábulo, em trânsito ou enquanto estiverem sendo exibidos na pista, até o momento da batida do martelo, passando então tais responsabilidades a serem exclusivas do comprador, não restando à Central Leilões Ltda nenhum ônus sobre os itens retro mencionados, bem como em caso de acidente e danos que, eventualmente, venha(m) a ocorrer com o(s) animal(is).

6.19. No caso de comercialização efetuada através de canal fechado de televisão (Leilões Virtuais), o vendedor compromete-se a entregar o(s) animal(is) (independente do local de entrega), somente quando tiver em sua posse a respectiva documentação de venda, devidamente assinada pelo comprador, eximindo a Central Leilões Ltda de qualquer responsabilidade se a presente cláusula não for cumprida.

7. DA AUTORIZAÇÃO DE USO DO NOME, IMAGEM E VOZ DOS PRESENTES AO LEILÃO:

7.1. A entrada da pessoa no recinto do leilão importará na presunção em favor da EMPRESA LEILOEIRA e do PROMOTOR DO EVENTO, sem ônus a estes, ao uso de seus NOMES, IMAGENS e SOM durante a realização do evento, bem como após a ocorrência deste para fins de divulgação do resultado final alcançado. Autorizam, também, a divulgação em periódicos e em site de todas as informações referentes ao leilão, tais como: nome do comprador, do vendedor, do animal ou produto comercializado e o valor efetivo da transação. Finalmente, fica autorizada a gravação de todas as imagens do leilão e dos participantes, bem como a transmissão ao vivo destas por canal fechado de televisão e, ainda, a divulgação de fotos em periódicos e em site próprio da EMPRESA LEILOEIRA.

8. DO CONTRATO DE COMPRA E VENDA:

8.1. Ao final da venda de cada lote a Central Leilões Ltda promoverá a emissão do contrato de compra e venda, bem como das notas promissórias referentes ao leilão, as quais serão assinadas imediatamente pelo vendedor e comprador. As notas fiscais referentes às vendas, que deverão ser emitidas pelos vendedores, bem como a nota fiscal da comissão de compra a ser emitida pela empresa leiloeira, serão efetuadas posteriormente.

8.2. Ficam fazendo parte integrante do contrato de compra e venda todas as regras constantes neste regulamento, bem como outras que forem estabelecidas pelo leiloeiro durante o leilão.

"É proibida a reprodução em parte ou no todo".



FAZENDA NOVA PARANAPANEMA

2024

CASETETE FNP

SEXO: MACHO - REG: FNP 7046 - RAÇA: NELORE PO - NASC.: 02/09/2021
 PESO: 902 KG - PE: 39 CM

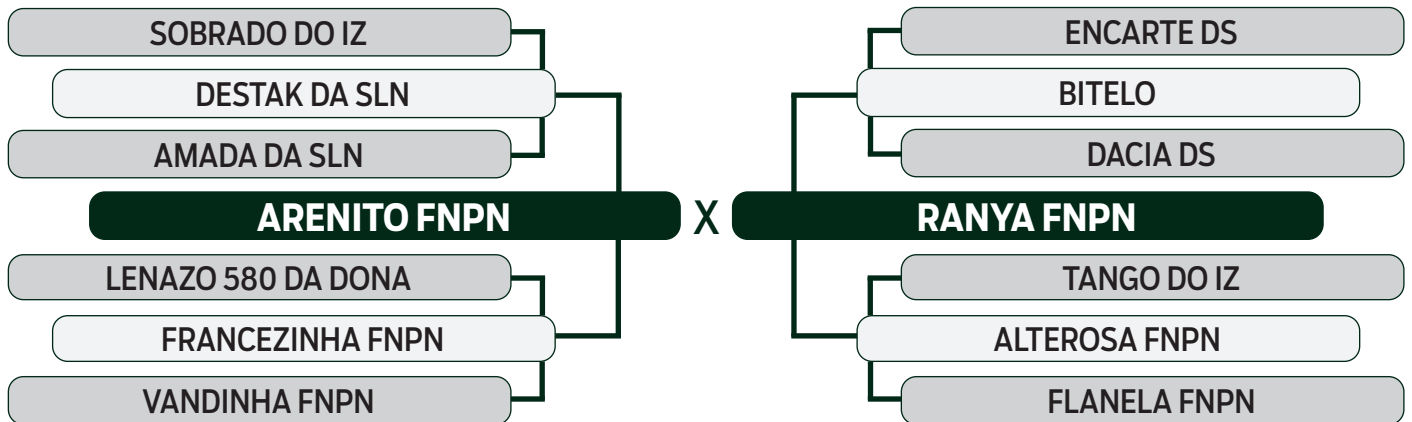

	iABCZ	PD-ED	PS-ED	PM-EM	TMD	IPP	STAY	PE-365	AOL	ACAB	MAR	M
DECA	17.90	9.20	15.79	-1.74	3.42	-24.93	39.05	0.168	2.429	-1.044	0.34	2.383
INDICE	1	1	1	9	3	1	1	5	1	9	4	1



	IQG	PD	TMD	PS	GPD	IPP	PES	AOL	EGS
TOP	16.456	9.204	3.424	15.786	6.582	-24.927	0.495	2.429	-1.044
INDICE	15%	4%	29%	6%	14%	2%	32%	6%	84%



FAZENDA NOVA PARANAPANEMA

01

DECOTE FNP

SEXO: MACHO - REG: FNP 7358 - RAÇA: NELORE PO - NASC.: 16/07/2022
 PESO: 739 KG - PE: 43 CM

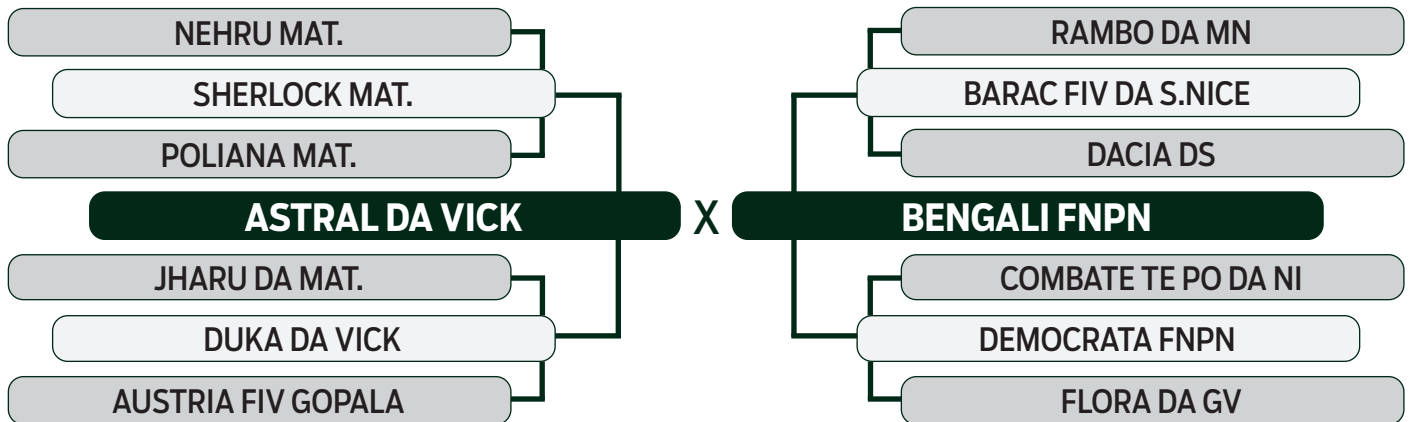

	iABCZ	PD-ED	PS-ED	PM-EM	TMD	IPP	STAY	PE-365	AOL	ACAB	MAR	M
DECA ÍNDICE	20.70	2.41	9.54	3.54	6.43	-33.31	43.27	1.005	1.455	-2.191	-1.20	2.399
	1	4	2	1	1	1	1	1	2	10	10	1



	IQG	PD	TMD	PS	GPD	IPP	PES	AOL	EGS
TOP ÍNDICE	26.838	2.413	6.430	9.538	7.125	-33.314	1.260	1.455	-2.191
	3%	49%	7%	24%	12%	0.5%	5%	21%	98%



Avaliação por Ultrassonografia										
AOL (cm ²)			ACABAMENTO (mm)			MARMOREIO (%)			ÍNDICE	RANK
OBS	GRUPO	CLASSE	OBS	GRUPO	CLASSE	OBS	GRUPO	CLASSE		
95.58	Superior	108	8.96	Elite	128	1.62	Regular	82	116.25	2



FAZENDA NOVA PARANAPANEMA

02

DESLIZE FNP

SEXO: MACHO - REG: FNP 7426 - RAÇA: NELORE PO - NASC.: 30/07/2022
 PESO: 661 KG - PE: 39 CM

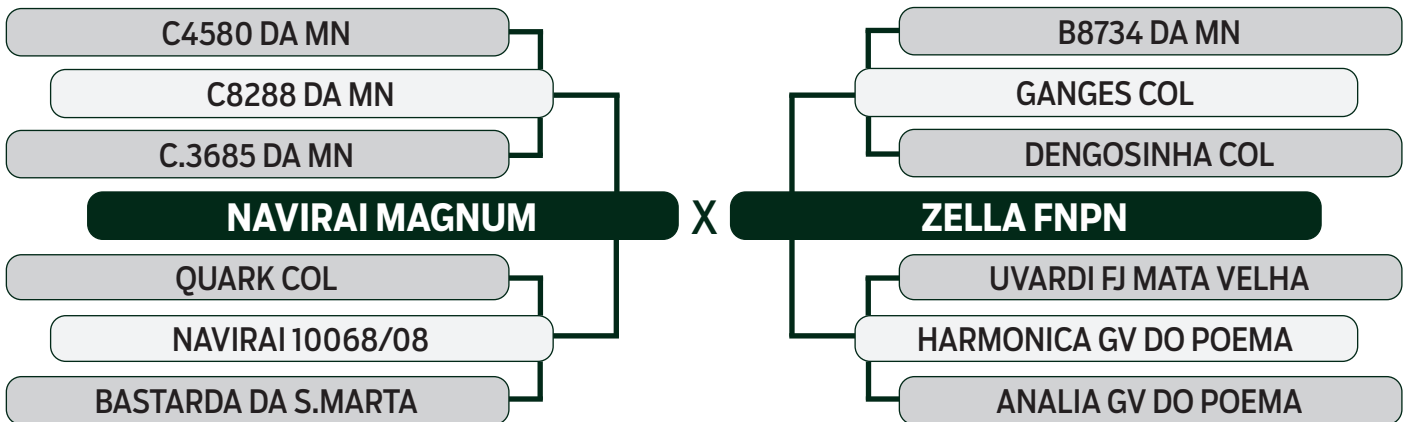

	iABCZ	PD-ED	PS-ED	PM-EM	TMD	IPP	STAY	PE-365	AOL	ACAB	MAR	M
DECA ÍNDICE	13.63	3.78	14.48	-0.12	1.75	-9.98	38.04	1.112	2.413	3.442	0.02	2.934
	1	3	1	6	4	3	1	1	1	1	5	1



	IQG	PD	TMD	PS	GPD	IPP	PES	AOL	EGS
TOP ÍNDICE	24.469	3.781	1.753	14.476	10.696	-9.975	1.432	2.413	3.442
	4%	35%	48%	9%	2%	28%	3%	6%	0.1%



Avaliação por Ultrassonografia										
AOL (cm ²)			ACABAMENTO (mm)			MARMOREIO (%)			ÍNDICE	RANK
OBS	GRUPO	CLASSE	OBS	GRUPO	CLASSE	OBS	GRUPO	CLASSE		
105.67	Elite	120	7.32	Superior	105	1.55	Inferior	79	106.43	6



FAZENDA NOVA PARANAPANEMA

03

DESENHO FNP

SEXO: MACHO - REG: FNP 7419 - RAÇA: NELORE PO - NASC.: 28/07/2022
 PESO: 635 KG - PE: 46 CM

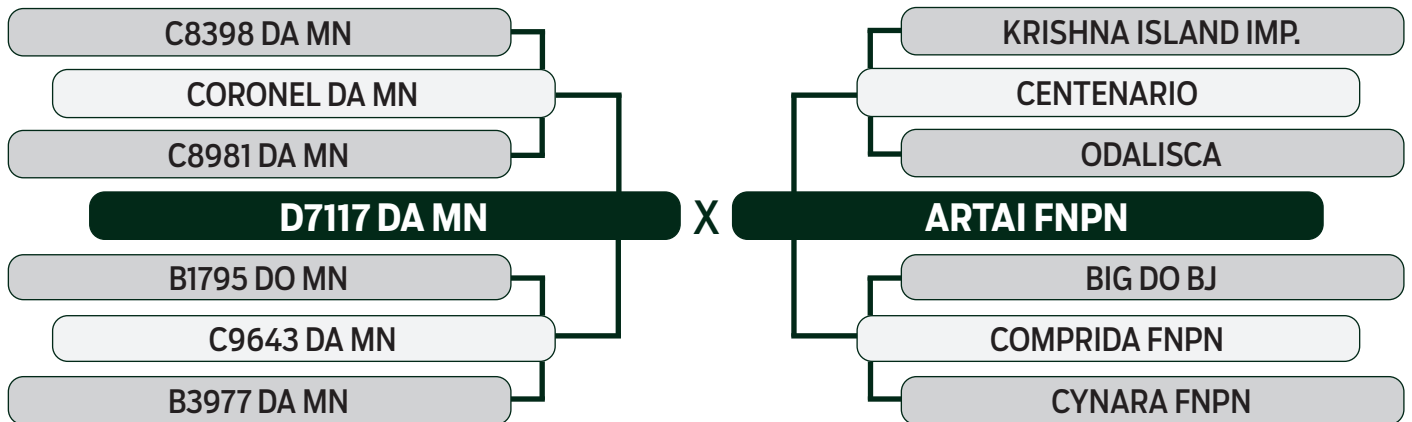

	iABCZ	PD-ED	PS-ED	PM-EM	TMD	IPP	STAY	PE-365	AOL	ACAB	MAR	M
DECA ÍNDICE	16.10	5.41	13.50	0.26	3.08	-24.32	36.72	1.062	2.643	0.283	0.14	1.903
	1	2	1	5	3	1	1	1	1	4	5	2



	IQG	PD	TMD	PS	GPD	IPP	PES	AOL	EGS
TOP ÍNDICE	20.124	5.411	3.075	13.496	8.085	-24.321	1.133	2.643	0.283
	9%	21%	33%	11%	8%	3%	7%	4%	41%



Avaliação por Ultrassonografia										
AOL (cm ²)			ACABAMENTO (mm)			MARMOREIO (%)			ÍNDICE	RANK
OBS	GRUPO	CLASSE	OBS	GRUPO	CLASSE	OBS	GRUPO	CLASSE		
85.54	Regular	97	5.51	Inferior	79	2.01	Superior	102	98.12	24



FAZENDA NOVA PARANAPANEMA

04

DANCANTE FNP

SEXO: MACHO - REG: FNP 7330 - RAÇA: NELORE PO - NASC.: 05/07/2022
 PESO: 673 KG - PE: 35.5 CM

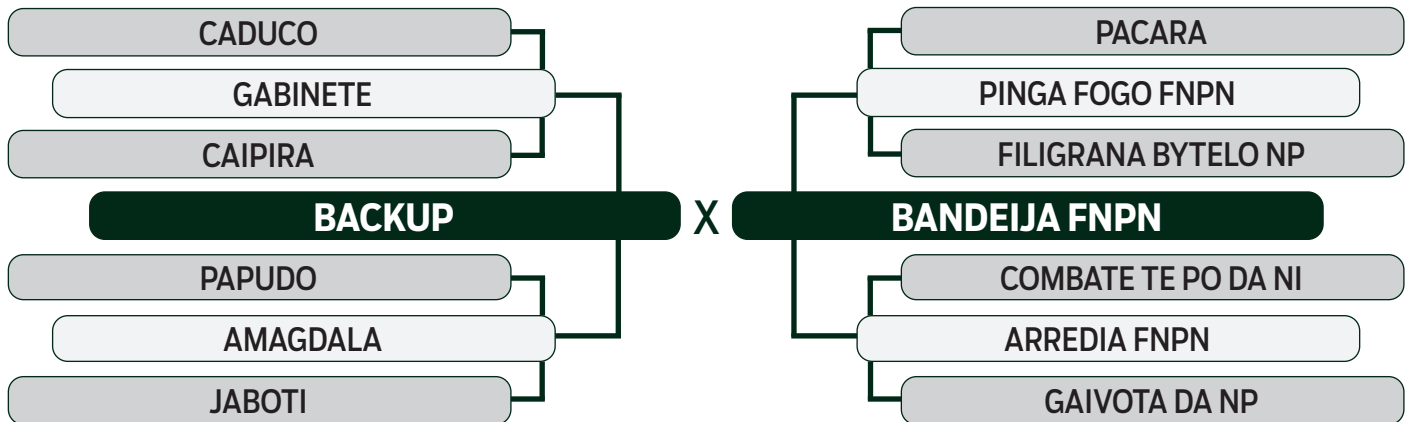

	iABCZ	PD-ED	PS-ED	PM-EM	TMD	IPP	STAY	PE-365	AOL	ACAB	MAR	M
DECA. ÍNDICE	12.34	3.21	10.45	-0.52	2.02	-15.32	39.46	0.142	3.052	2.438	2.23	-0.368
	1	4	2	7	4	1	1	5	1	1	1	7



	IQG	PD	TMD	PS	GPD	IPP	PES	AOL	EGS
TOP. ÍNDICE	23.494	3.206	2.021	10.447	7.241	-15.315	0.691	3.051	2.438
	5%	41%	45%	20%	11%	14%	22%	2%	2%



Avaliação por Ultrassonografia										
AOL (cm ²)			ACABAMENTO (mm)			MARMOREIO (%)			ÍNDICE	RANK
OBS	GRUPO	CLASSE	OBS	GRUPO	CLASSE	OBS	GRUPO	CLASSE		
87.78	Regular	100	9.82	Elite	141	2.51	Elite	128	108.05	4



FAZENDA NOVA PARANAPANEMA

05

DADIVOSO FNP

SEXO: MACHO - REG: FNP 7327 - RAÇA: NELORE PO - NASC.: 05/07/2022
 PESO: 678 KG - PE: 40 CM

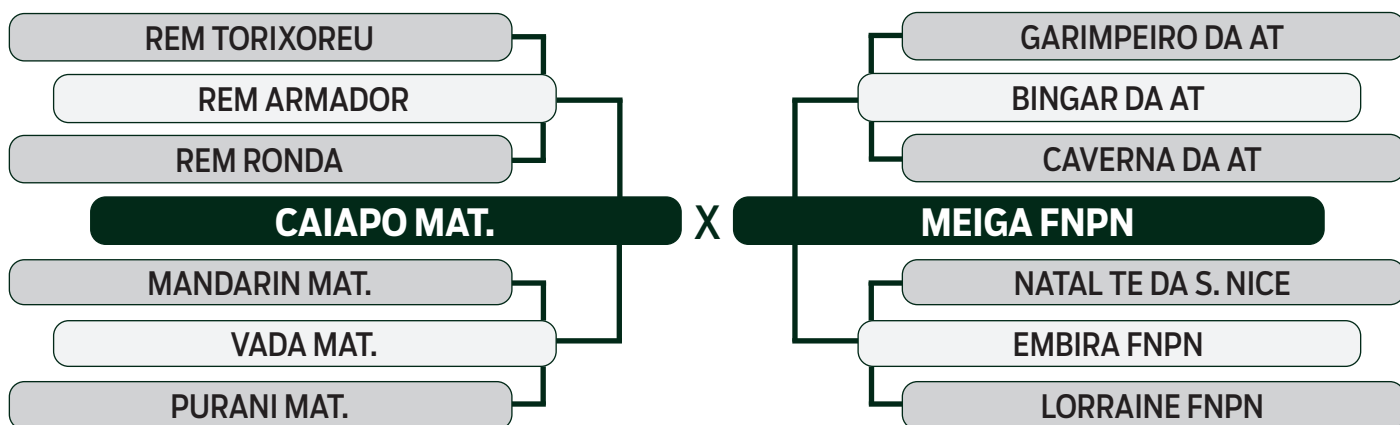

	iABCZ	PD-ED	PS-ED	PM-EM	TMD	IPP	STAY	PE-365	AOL	ACAB	MAR	M
DECA ÍNDICE	16.82	12.10	19.35	-0.36	5.39	-4.29	38.21	-0.044	1.240	-1.108	-1.32	5.111
	1	1	1	7	1	5	1	7	2	9	10	1



	IQG	PD	TMD	PS	GPD	IPP	PES	AOL	EGS
TOP ÍNDICE	15.087	12.096	5.389	19.351	7.255	-4.287	0.011	1.240	-1.108
	18%	0.5%	13%	2%	11%	48%	63%	26%	86%



Avaliação por Ultrassonografia										
AOL (cm ²)			ACABAMENTO (mm)			MARMOREIO (%)			ÍNDICE	RANK
OBS	GRUPO	CLASSE	OBS	GRUPO	CLASSE	OBS	GRUPO	CLASSE		
80.05	Regular	91	6.82	Regular	98	1.67	Regular	85	99.33	20



FAZENDA NOVA PARANAPANEMA

06

DEFINITIVO FNP

SEXO: MACHO - REG: FNP 7366 - RAÇA: NELORE PO - NASC.: 16/07/2022
PESO: 673 KG - PE: 38.5 CM

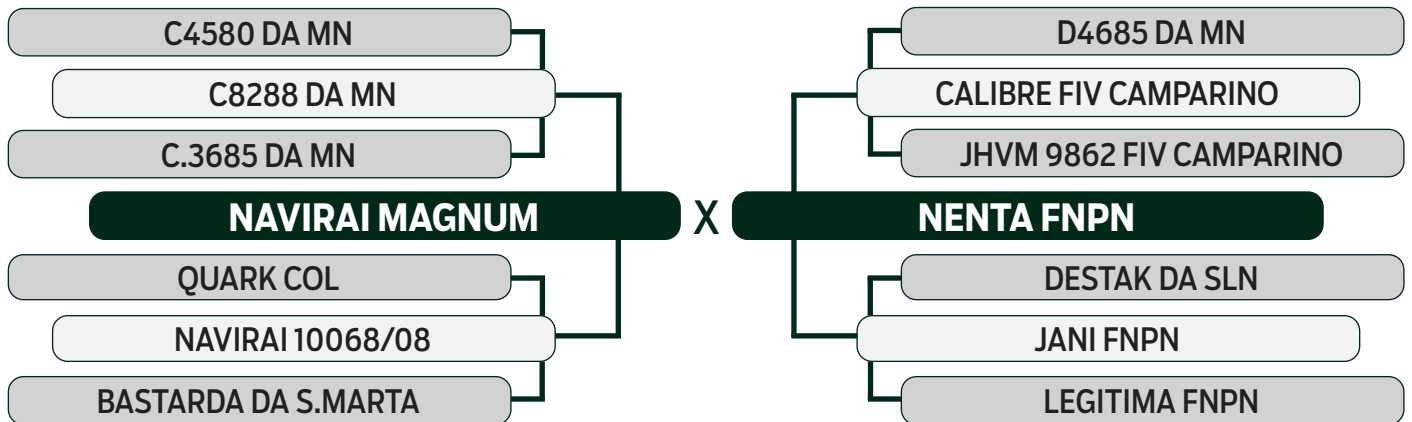

	iABCZ	PD-ED	PS-ED	PM-EM	TMD	IPP	STAY	PE-365	AOL	ACAB	MAR	M
DECA ÍNDICE	12.55	6.15	13.58	-0.61	2.54	-4.15	36.90	0.964	0.796	2.335	0.35	3.038
	1	1	1	7	4	5	1	1	4	1	4	1



	IQG	PD	TMD	PS	GPD	IPP	PES	AOL	EGS
TOP ÍNDICE	17.738	6.154	2.535	13.580	7.427	-4.153	1.112	0.795	2.335
	13%	15%	39%	11%	10%	49%	7%	38%	2%



Avaliação por Ultrassonografia										
AOL (cm ²)			ACABAMENTO (mm)			MARMOREIO (%)			ÍNDICE	RANK
OBS	GRUPO	CLASSE	OBS	GRUPO	CLASSE	OBS	GRUPO	CLASSE		
88.55	Superior	100	7.82	Superior	112	2.00	Superior	102	102.78	14



FAZENDA NOVA PARANAPANEMA

07

DIFUNDIDO FNP

SEXO: MACHO - REG: FNP 7572 - RAÇA: NELORE PO - NASC.: 11/10/2022
 PESO: 628 KG - PE: 35 CM

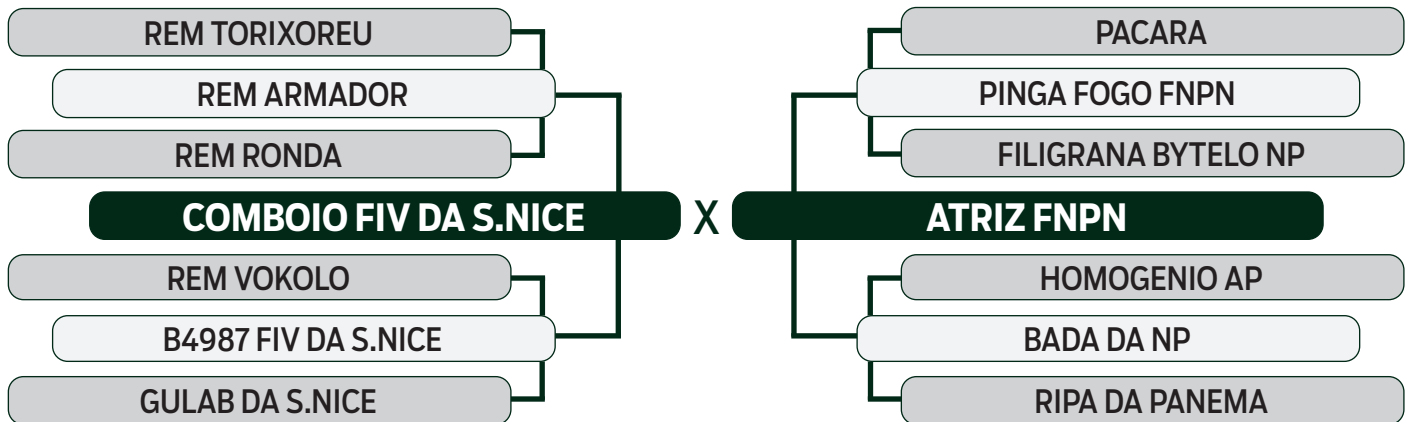

	iABCZ	PD-ED	PS-ED	PM-EM	TMD	IPP	STAY	PE-365	AOL	ACAB	MAR	M
DECA ÍNDICE	20.80	12.45	16.20	0.20	7.02	-9.04	41.44	0.804	0.636	-0.253	0.25	2.279
	1	1	1	5	1	3	1	1	4	6	4	2



	IQG	PD	TMD	PS	GPD	IPP	PES	AOL	EGS
TOP ÍNDICE	22.139	12.447	7.016	16.198	3.750	-9.042	1.002	0.636	-0.253
	7%	0.5%	5%	6%	34%	31%	10%	43%	61%



Avaliação por Ultrassonografia										
AOL (cm ²)			ACABAMENTO (mm)			MARMOREIO (%)			ÍNDICE	RANK
OBS	GRUPO	CLASSE	OBS	GRUPO	CLASSE	OBS	GRUPO	CLASSE		
82.12	Regular	93	4.44	Inferior	64	2.08	Superior	106	92.31	32



FAZENDA NOVA PARANAPANEMA

08

DESAFORADO FNP

SEXO: MACHO - REG: FNP 7397 - RAÇA: NELORE PO - NASC.: 22/07/2022
 PESO: 697 KG - PE: 37 CM

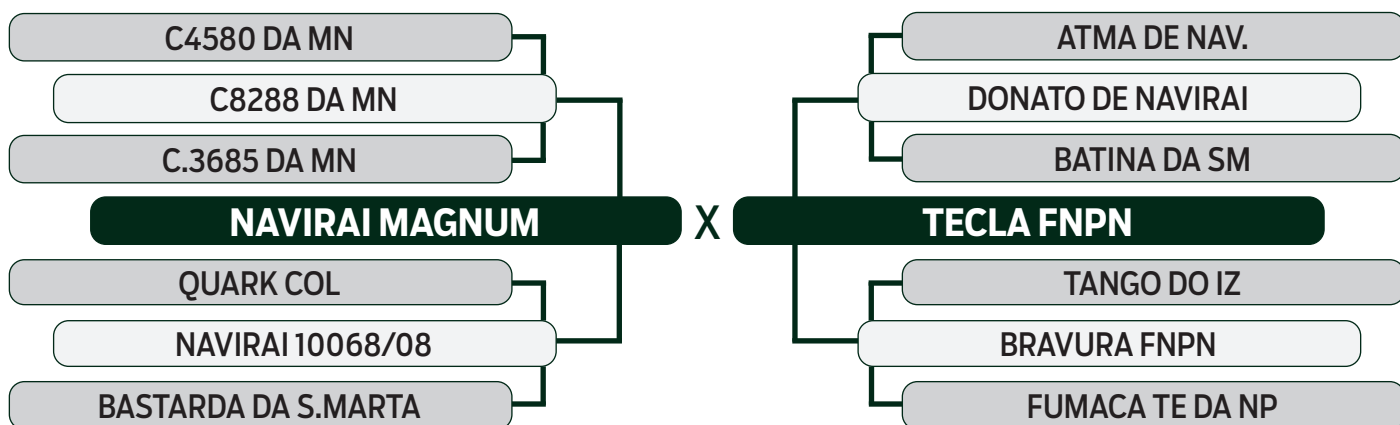

	iABCZ	PD-ED	PS-ED	PM-EM	TMD	IPP	STAY	PE-365	AOL	ACAB	MAR	M
DECA ÍNDICE	19.47	8.20	15.96	1.96	7.10	-19.38	39.94	0.530	0.800	1.393	-0.25	3.533
	1	1	1	2	1	1	1	2	4	1	7	1



	IQG	PD	TMD	PS	GPD	IPP	PES	AOL	EGS
TOP ÍNDICE	25.000	8.198	7.099	15.959	7.761	-19.379	0.997	0.800	1.393
	4%	6%	5%	6%	9%	7%	10%	38%	11%



Avaliação por Ultrassonografia										
AOL (cm ²)			ACABAMENTO (mm)			MARMOREIO (%)			ÍNDICE	RANK
OBS	GRUPO	CLASSE	OBS	GRUPO	CLASSE	OBS	GRUPO	CLASSE		
96.25	Superior	109	7.96	Superior	114	2.78	Elite	142	106.34	7



FAZENDA NOVA PARANAPANEMA

09

DESNIVEL FNP

SEXO: MACHO - REG: FNP 7402 - RAÇA: NELORE PO - NASC.: 23/07/2022
PESO: 689 KG - PE: 33 CM

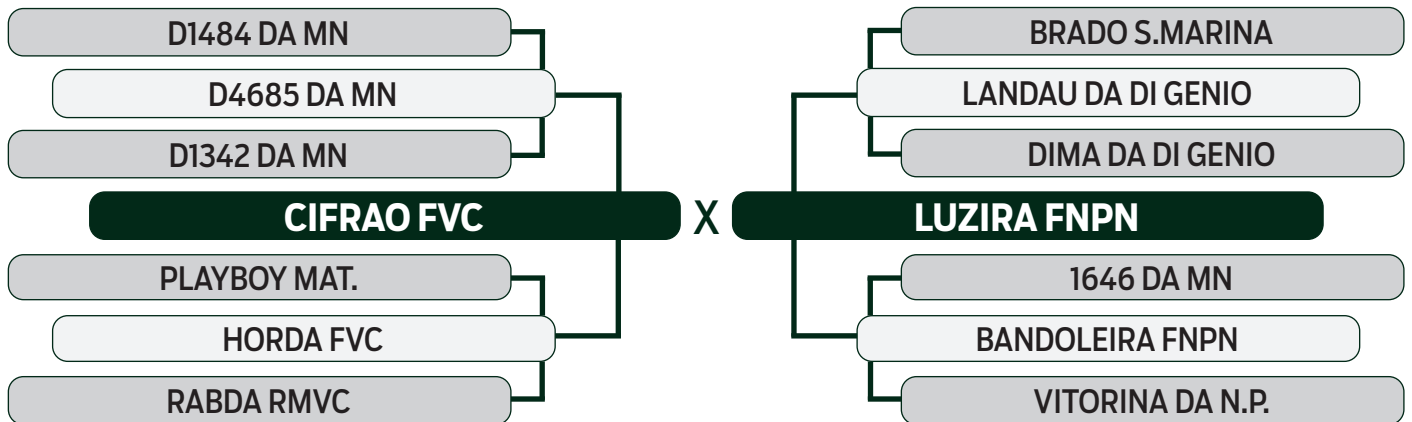

	iABCZ	PD-ED	PS-ED	PM-EM	TMD	IPP	STAY	PE-365	AOL	ACAB	MAR	M
DECA ÍNDICE	13.39	4.31	13.95	3.37	5.75	-18.98	34.02	-0.015	1.945	2.799	0.23	0.636
	1	3	1	1	1	1	2	6	1	1	4	5



	IQG	PD	TMD	PS	GPD	IPP	PES	AOL	EGS
TOP ÍNDICE	21.854	4.306	5.754	13.953	9.647	-18.974	-0.134	1.945	2.799
	7%	30%	11%	10%	4%	7%	72%	12%	1%



Avaliação por Ultrassonografia										
AOL (cm ²)			ACABAMENTO (mm)			MARMOREIO (%)			ÍNDICE	RANK
OBS	GRUPO	CLASSE	OBS	GRUPO	CLASSE	OBS	GRUPO	CLASSE		
97.45	Elite	111	9.51	Elite	136	2.27	Superior	116	109.75	3



FAZENDA NOVA PARANAPANEMA

10

DECANO FNP

SEXO: MACHO - REG: FNP 7344 - RAÇA: NELORE PO - NASC.: 14/07/2022
 PESO: 634 KG - PE: 34 CM

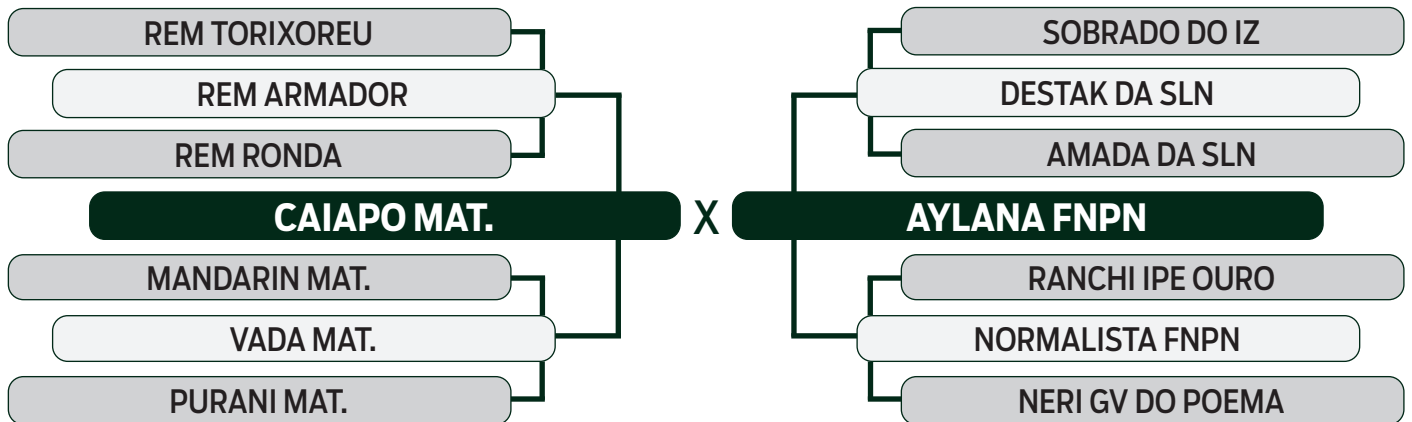

	iABCZ	PD-ED	PS-ED	PM-EM	TMD	IPP	STAY	PE-365	AOL	ACAB	MAR	M
DECA ÍNDICE	8.78	7.92	11.55	-3.98	0.03	10.24	38.28	0.356	3.049	-0.706	-0.37	3.382
	2	1	2	10	6	9	1	3	1	8	7	1



	IQG	PD	TMD	PS	GPD	IPP	PES	AOL	EGS
TOP ÍNDICE	10.744	7.918	0.034	11.548	3.630	10.244	0.615	3.049	-0.706
	29%	7%	68%	16%	36%	92%	26%	2%	76%



Avaliação por Ultrassonografia										
AOL (cm ²)			ACABAMENTO (mm)			MARMOREIO (%)			ÍNDICE	RANK
OBS	GRUPO	CLASSE	OBS	GRUPO	CLASSE	OBS	GRUPO	CLASSE		
95.48	Superior	108	5.79	Regular	83	2.21	Superior	113	93.87	30



FAZENDA NOVA PARANAPANEMA

11

DEPOENTE FNP

SEXO: MACHO - REG: FNP 7374 - RAÇA: NELORE PO - NASC.: 20/07/2022
 PESO: 686 KG - PE: 40.5 CM

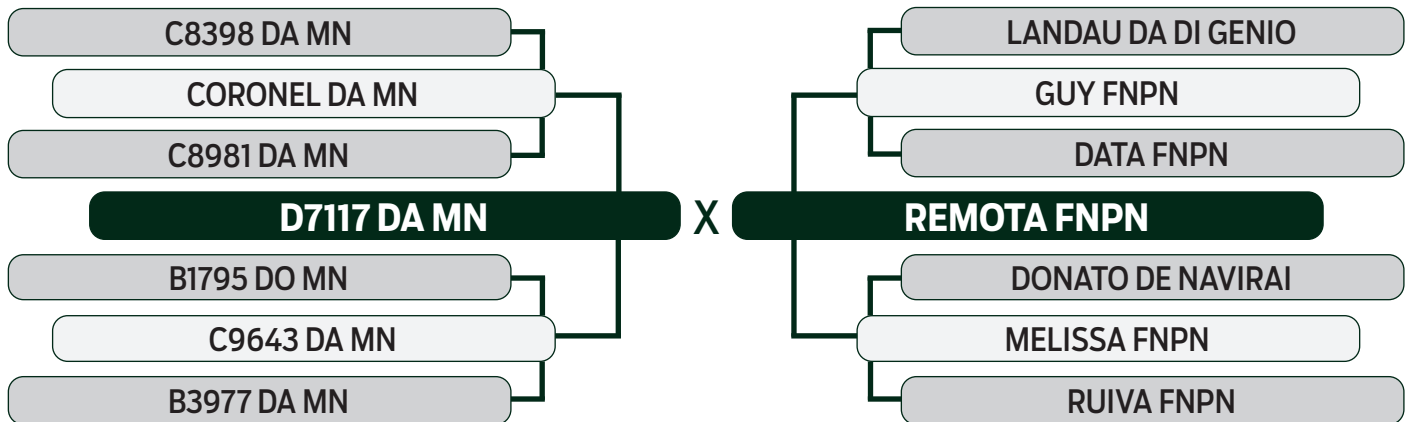

	iABCZ	PD-ED	PS-ED	PM-EM	TMD	IPP	STAY	PE-365	AOL	ACAB	MAR	M
DECA ÍNDICE	19.26	9.52	19.68	2.70	8.32	-25.40	33.87	0.481	1.382	-0.234	0.45	-0.009
	1	1	1	1	1	1	2	2	2	6	3	6



	IQG	PD	TMD	PS	GPD	IPP	PES	AOL	EGS
TOP ÍNDICE	22.894	9.524	8.321	19.682	10.159	-25.402	1.173	1.382	-0.234
	6%	3%	3%	2%	3%	2%	6%	23%	60%



Avaliação por Ultrassonografia										
AOL (cm ²)			ACABAMENTO (mm)			MARMOREIO (%)			ÍNDICE	RANK
OBS	GRUPO	CLASSE	OBS	GRUPO	CLASSE	OBS	GRUPO	CLASSE		
102.03	Elite	116	4.59	Inferior	66	1.87	Regular	95	96.45	27



FAZENDA NOVA PARANAPANEMA

12

DYLAN FNP

SEXO: MACHO - REG: FNP 7481 - RAÇA: NELORE PO - NASC.: 29/08/2022
 PESO: 638 KG - PE: 32.5 CM

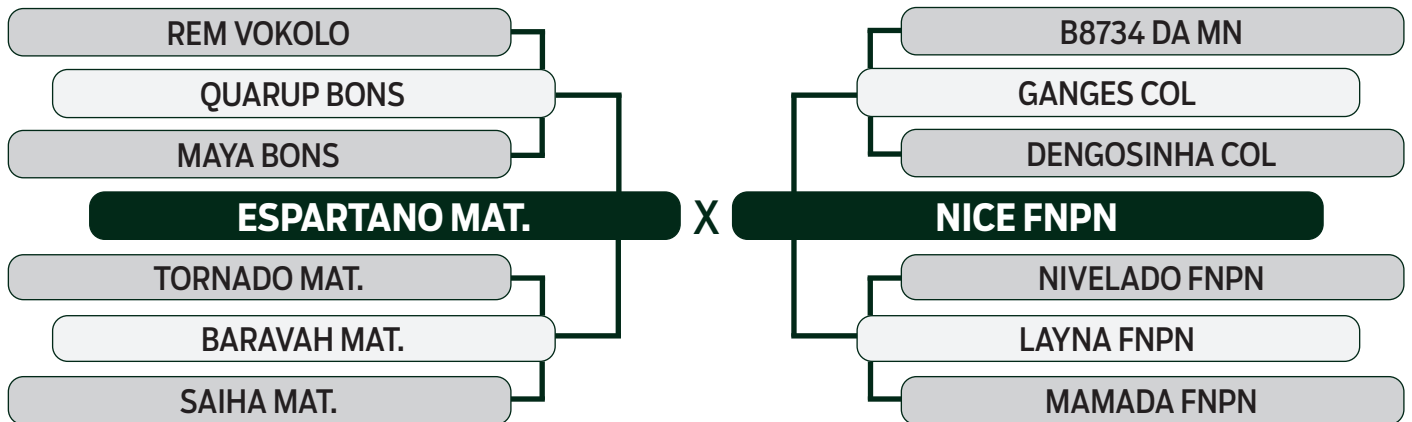

	iABCZ	PD-ED	PS-ED	PM-EM	TMD	IPP	STAY	PE-365	AOL	ACAB	MAR	M
DECA ÍNDICE	21.69	9.31	15.08	-0.35	3.81	-28.97	41.84	1.143	2.882	2.376	-0.16	6.056
	1	1	1	7	2	1	1	1	1	1	6	1



	IQG	PD	TMD	PS	GPD	IPP	PES	AOL	EGS
TOP ÍNDICE	30.096	9.311	3.810	15.076	5.765	-28.967	1.757	2.882	2.376
	2%	3%	25%	7%	19%	1%	1%	3%	2%



Avaliação por Ultrassonografia										
AOL (cm ²)			ACABAMENTO (mm)			MARMOREIO (%)			ÍNDICE	RANK
OBS	GRUPO	CLASSE	OBS	GRUPO	CLASSE	OBS	GRUPO	CLASSE		
90.82	Superior	103	6.98	Regular	100	1.95	Regular	100	98.56	22



FAZENDA NOVA PARANAPANEMA

13

DORAVANTE FNP

SEXO: MACHO - REG: FNP 7525 - RAÇA: NELORE PO - NASC.: 19/09/2022
 PESO: 684 KG - PE: 35 CM

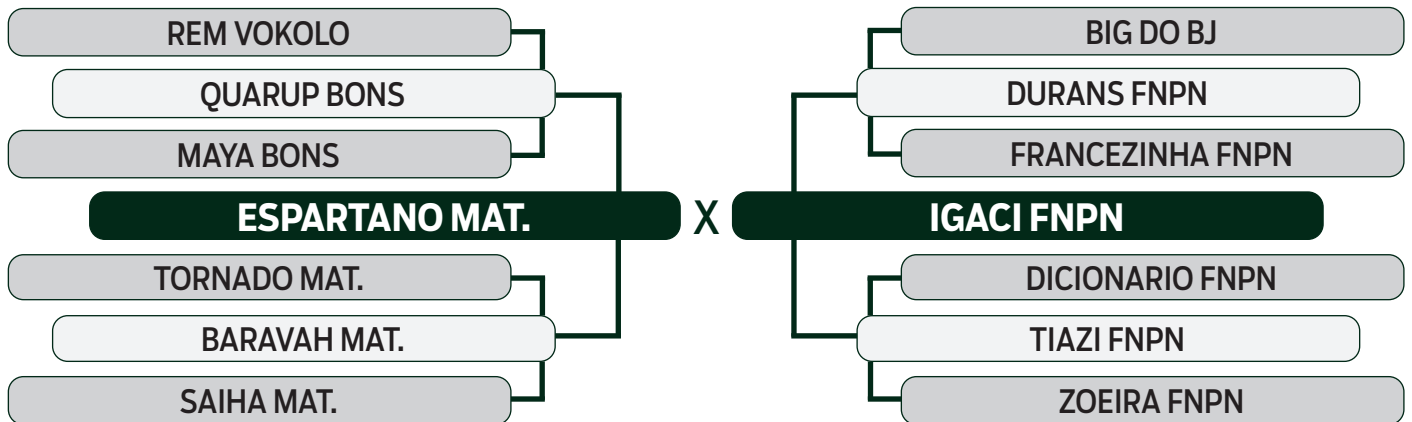

	iABCZ	PD-ED	PS-ED	PM-EM	TMD	IPP	STAY	PE-365	AOL	ACAB	MAR	M
DECA ÍNDICE	17.80	10.85	24.39	-0.77	4.12	-7.90	35.55	0.959	2.942	3.075	0.78	4.910
	1	1	1	8	2	3	1	1	1	1	2	1



	IQG	PD	TMD	PS	GPD	IPP	PES	AOL	EGS
TOP ÍNDICE	25.809	10.855	4.122	24.388	13.533	-7.902	0.555	2.942	3.075
	4%	2%	22%	0.5%	0.5%	35%	29%	3%	0.5%



Avaliação por Ultrassonografia										
AOL (cm ²)			ACABAMENTO (mm)			MARMOREIO (%)			ÍNDICE	RANK
OBS	GRUPO	CLASSE	OBS	GRUPO	CLASSE	OBS	GRUPO	CLASSE		
90.29	Superior	102	10.16	Elite	146	2.48	Elite	126	116.83	1



FAZENDA NOVA PARANAPANEMA

14

DEFENSE FNP

SEXO: MACHO - REG: FNP 7469 - RAÇA: NELORE PO - NASC.: 25/08/2022
 PESO: 566 KG - PE: 35 CM

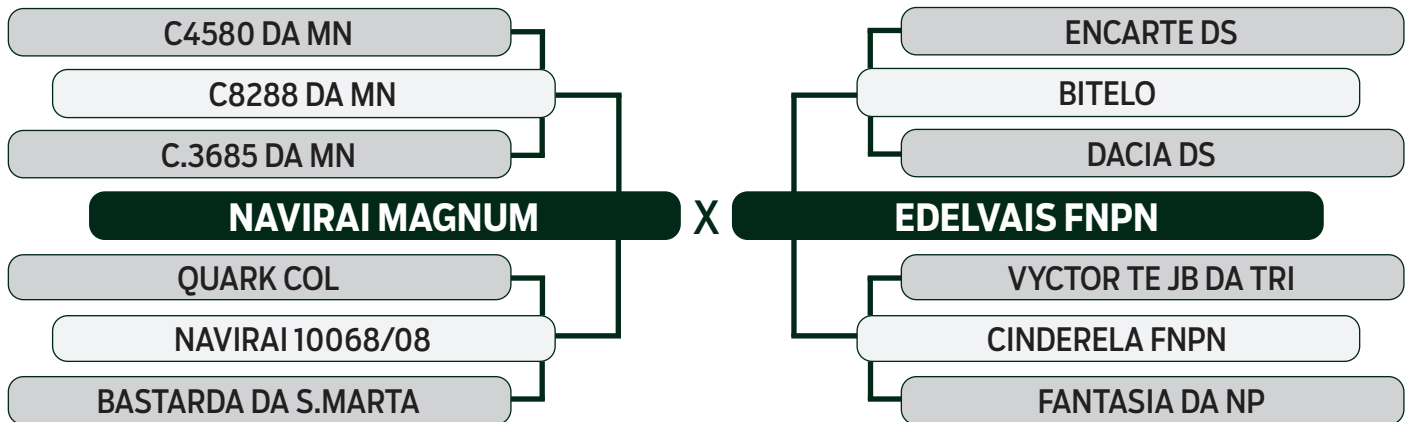

	iABCZ	PD-ED	PS-ED	PM-EM	TMD	IPP	STAY	PE-365	AOL	ACAB	MAR	M
DECA ÍNDICE	13.77	-1.01	3.05	-0.23	-0.22	-19.93	46.54	0.701	-0.146	1.407	1.00	3.362
	1	8	5	6	7	1	1	1	7	1	2	1



	IQG	PD	TMD	PS	GPD	IPP	PES	AOL	EGS
TOP ÍNDICE	19.643	-1.008	-0.218	3.050	4.057	-19.932	0.794	-0.146	1.407
	10%	82%	71%	57%	32%	6%	17%	67%	11%



Avaliação por Ultrassonografia										
AOL (cm ²)			ACABAMENTO (mm)			MARMOREIO (%)			ÍNDICE	RANK
OBS	GRUPO	CLASSE	OBS	GRUPO	CLASSE	OBS	GRUPO	CLASSE		
78.63	Inferior	89	7.60	Superior	109	2.56	Elite	130	95.26	28



FAZENDA NOVA PARANAPANEMA

15

DESAFORO FNP

SEXO: MACHO - REG: FNP 7390 - RAÇA: NELORE PO - NASC.: 21/07/2022
 PESO: 587 KG - PE: 34.5 CM

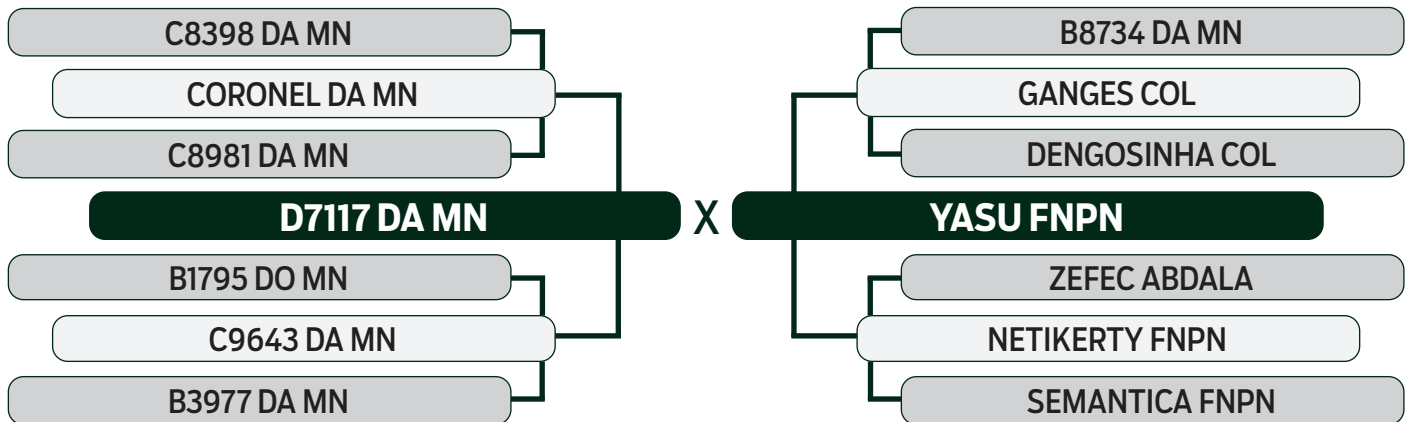

	iABCZ	PD-ED	PS-ED	PM-EM	TMD	IPP	STAY	PE-365	AOL	ACAB	MAR	M
DECA. INDICE	9.83	4.23	12.28	-1.73	0.36	-13.11	34.35	0.499	1.504	-0.678	-1.06	2.918
	2	3	1	9	6	2	2	2	2	8	9	1



	IQG	PD	TMD	PS	GPD	IPP	PES	AOL	EGS
TOP. INDICE	12.561	4.228	0.362	12.281	8.053	-13.106	0.721	1.504	-0.678
	24%	31%	64%	14%	8%	19%	20%	20%	75%



Avaliação por Ultrassonografia										
AOL (cm ²)			ACABAMENTO (mm)			MARMOREIO (%)			ÍNDICE	RANK
OBS	GRUPO	CLASSE	OBS	GRUPO	CLASSE	OBS	GRUPO	CLASSE		
84.81	Regular	96	5.35	Inferior	77	1.91	Regular	97	88.29	36



FAZENDA NOVA PARANAPANEMA

16

DESCORTINO FNP

SEXO: MACHO - REG: FNP 7408 - RAÇA: NELORE PO - NASC.: 25/07/2022
 PESO: 652 KG - PE: 40 CM

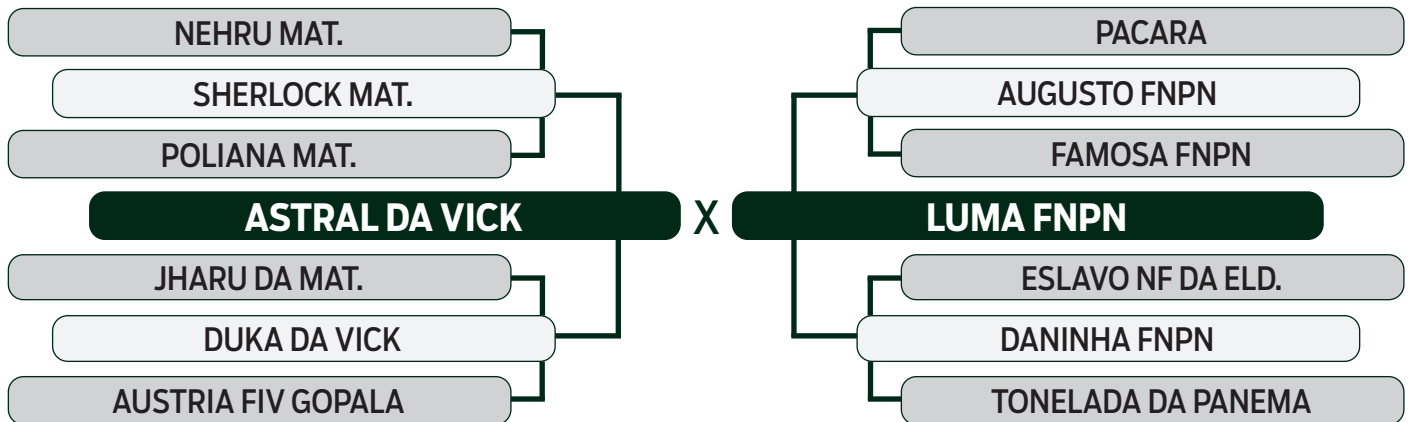

	iABCZ	PD-ED	PS-ED	PM-EM	TMD	IPP	STAY	PE-365	AOL	ACAB	MAR	M
DECA ÍNDICE	9.95	3.99	5.59	2.09	6.24	-4.65	33.70	1.115	1.325	0.028	-0.41	1.989
	2	3	4	2	1	4	3	1	2	5	7	2



	IQG	PD	TMD	PS	GPD	IPP	PES	AOL	EGS
TOP ÍNDICE	15.842	3.993	6.240	5.586	1.592	-4.647	1.124	1.325	0.028
	16%	33%	8%	43%	54%	47%	7%	24%	51%



Avaliação por Ultrassonografia										
AOL (cm ²)			ACABAMENTO (mm)			MARMOREIO (%)			ÍNDICE	RANK
OBS	GRUPO	CLASSE	OBS	GRUPO	CLASSE	OBS	GRUPO	CLASSE		
87.12	Regular	99	7.80	Superior	112	1.52	Inferior	78	103.62	11



FAZENDA NOVA PARANAPANEMA

17

DUEL FNP

SEXO: MACHO - REG: FNP 7465 - RAÇA: NELORE PO - NASC.: 24/08/2022
 PESO: 649 KG - PE: 37.5 CM

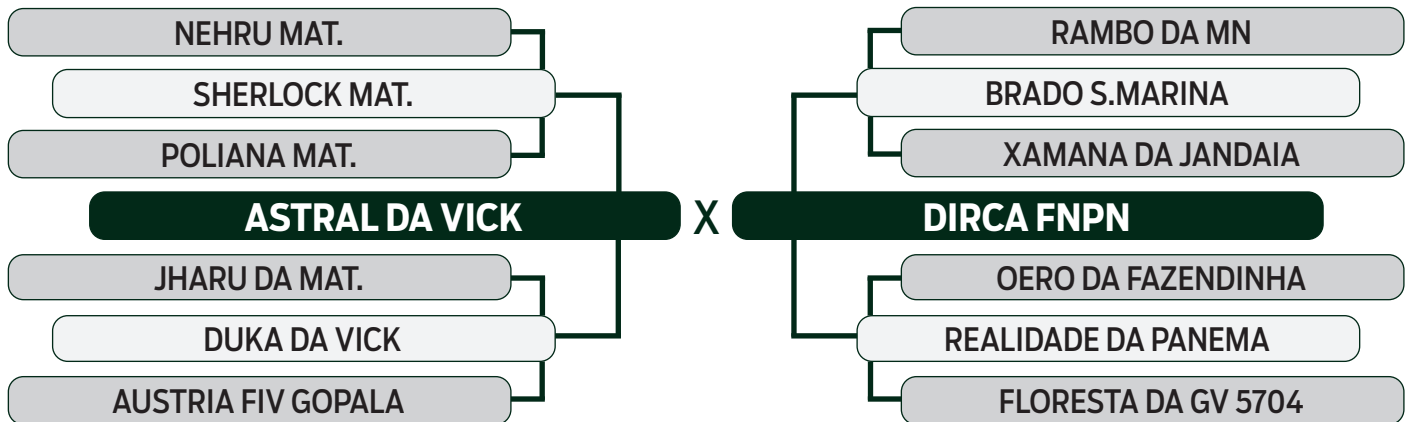

	iABCZ	PD-ED	PS-ED	PM-EM	TMD	IPP	STAY	PE-365	AOL	ACAB	MAR	M
DECA ÍNDICE	13.79	5.42	11.70	-0.58	3.19	-17.22	34.72	1.719	0.731	-1.180	-1.17	3.314
	1	2	1	7	3	1	2	1	4	9	10	1



	IQG	PD	TMD	PS	GPD	IPP	PES	AOL	EGS
TOP ÍNDICE	15.740	5.416	3.189	11.696	6.280	-17.215	1.444	0.731	-1.180
	16%	21%	31%	16%	16%	10%	3%	40%	87%



Avaliação por Ultrassonografia										
AOL (cm ²)			ACABAMENTO (mm)			MARMOREIO (%)			ÍNDICE	RANK
OBS	GRUPO	CLASSE	OBS	GRUPO	CLASSE	OBS	GRUPO	CLASSE		
87.50	Regular	99	5.80	Regular	83	1.75	Regular	89	96.88	26



FAZENDA NOVA PARANAPANEMA

18

DESTACADO FNP

SEXO: MACHO - REG: FNP 7452 - RAÇA: NELORE PO - NASC.: 11/08/2022
 PESO: 628 KG - PE: 37 CM

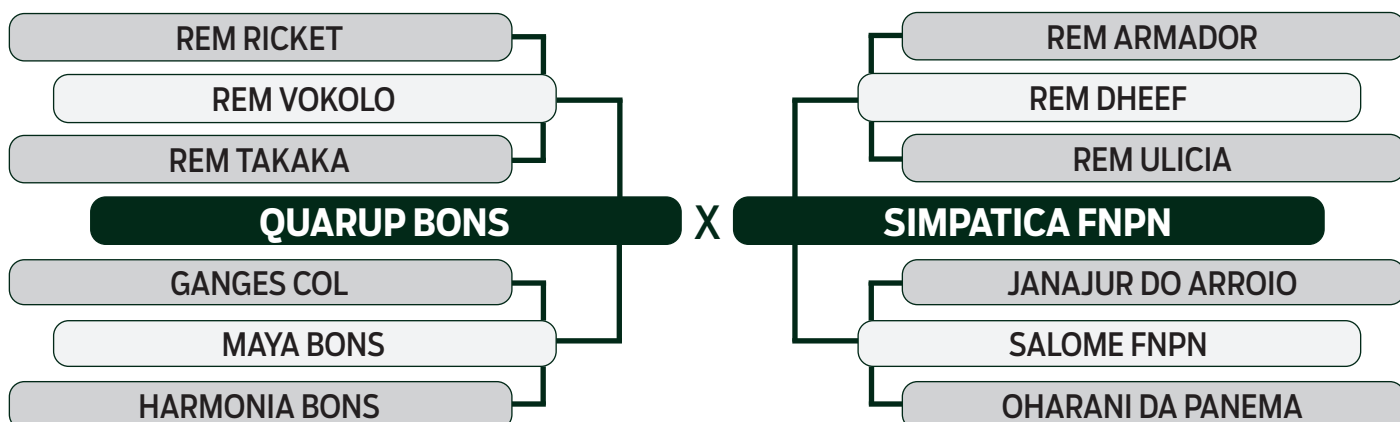

	iABCZ	PD-ED	PS-ED	PM-EM	TMD	IPP	STAY	PE-365	AOL	ACAB	MAR	M
DECA ÍNDICE	20.03	8.08	13.18	0.83	4.90	-13.15	43.35	1.112	2.457	0.514	0.33	3.876
	1	1	1	4	2	2	1	1	1	3	4	1



	IQG	PD	TMD	PS	GPD	IPP	PES	AOL	EGS
TOP ÍNDICE	25.526	8.081	4.904	13.177	5.096	-13.148	1.607	2.457	0.514
	4%	7%	16%	12%	24%	19%	2%	6%	33%



Avaliação por Ultrassonografia										
AOL (cm ²)			ACABAMENTO (mm)			MARMOREIO (%)			ÍNDICE	RANK
OBS	GRUPO	CLASSE	OBS	GRUPO	CLASSE	OBS	GRUPO	CLASSE		
86.35	Regular	98	6.25	Regular	90	1.49	Inferior	76	93.60	31



FAZENDA NOVA PARANAPANEMA

19

DERIVADO FNP

SEXO: MACHO - REG: FNP 7377 - RAÇA: NELORE PO - NASC.: 20/07/2022
 PESO: 611 KG - PE: 36.5 CM

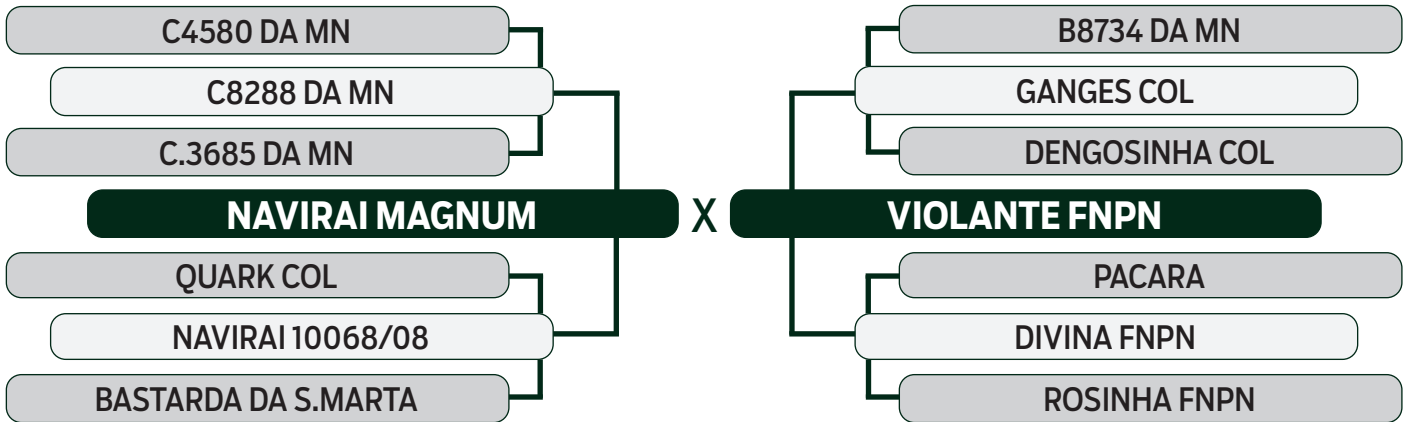

	iABCZ	PD-ED	PS-ED	PM-EM	TMD	IPP	STAY	PE-365	AOL	ACAB	MAR	M
DECA ÍNDICE	21.47	7.50	13.02	1.61	6.43	-24.21	44.06	0.440	1.291	2.007	0.70	4.420
	1	1	1	2	1	1	1	2	2	1	2	1



	IQG	PD	TMD	PS	GPD	IPP	PES	AOL	EGS
TOP ÍNDICE	26.531	7.495	6.427	13.023	5.528	-24.209	0.921	1.291	2.007
	3%	9%	8%	12%	21%	3%	12%	25%	4%



Avaliação por Ultrassonografia										
AOL (cm²)			ACABAMENTO (mm)			MARMOREIO (%)			ÍNDICE	RANK
OBS	GRUPO	CLASSE	OBS	GRUPO	CLASSE	OBS	GRUPO	CLASSE		
91.79	Superior	104	8.52	Elite	122	2.76	Elite	141	101.72	16



FAZENDA NOVA PARANAPANEMA

20

DELEGADO FNP

SEXO: MACHO - REG: FNP 7369 - RAÇA: NELORE PO - NASC.: 17/07/2022
 PESO: 615 KG - PE: 35 CM

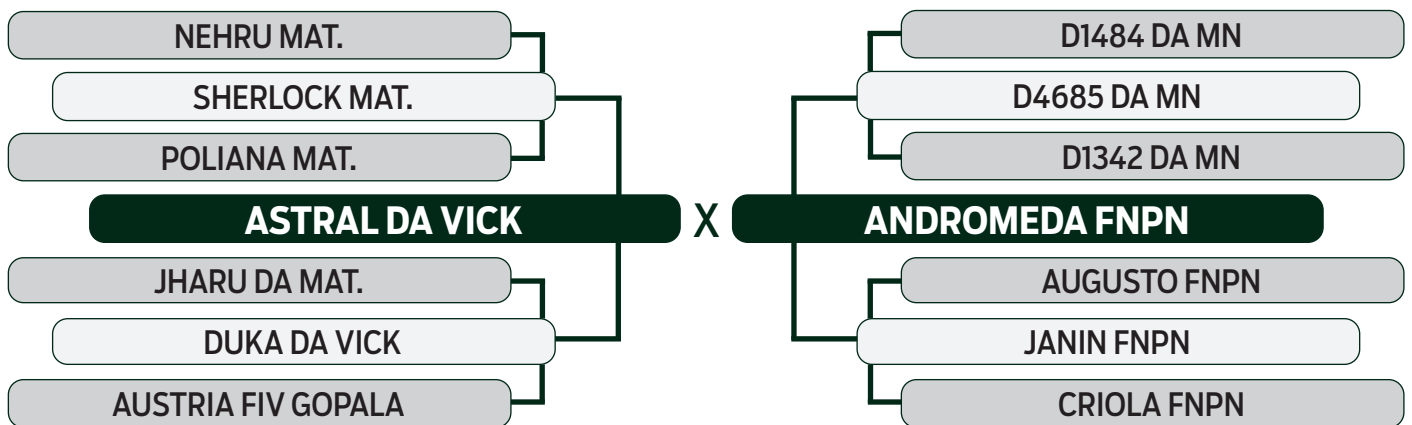

	iABCZ	PD-ED	PS-ED	PM-EM	TMD	IPP	STAY	PE-365	AOL	ACAB	MAR	M
DECA	20.73	8.85	18.31	0.54	5.08	-15.11	41.80	0.990	0.880	0.320	-1.89	4.145
INDICE	1	1	1	5	1	1	1	1	3	4	10	1



	IQG	PD	TMD	PS	GPD	IPP	PES	AOL	EGS
TOP	25.984	8.847	5.077	18.308	9.461	-15.107	1.349	0.880	0.320
INDICE	3%	4%	15%	3%	4%	14%	3%	36%	40%



Avaliação por Ultrassonografia										
AOL (cm ²)			ACABAMENTO (mm)			MARMOREIO (%)			ÍNDICE	RANK
OBS	GRUPO	CLASSE	OBS	GRUPO	CLASSE	OBS	GRUPO	CLASSE		
86.00	Regular	98	8.92	Elite	128	1.55	Inferior	79	103.12	13



FAZENDA NOVA PARANAPANEMA

21

DERUP FNP

SEXO: MACHO - REG: FNP 7515 - RAÇA: NELORE PO - NASC.: 16/09/2022
PESO: 640 KG - PE: 35 CM

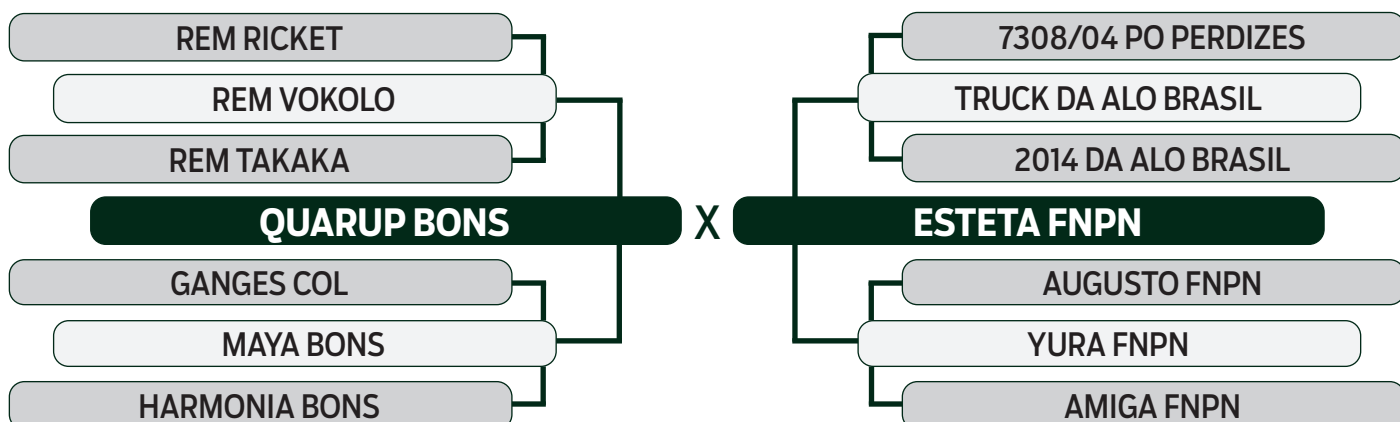

	iABCZ	PD-ED	PS-ED	PM-EM	TMD	IPP	STAY	PE-365	AOL	ACAB	MAR	M
DECA ÍNDICE	20.08	6.84	20.59	3.84	8.66	-7.04	37.89	1.475	4.383	1.617	-1.58	4.974
	1	1	1	1	1	4	1	1	1	1	10	1



	IQG	PD	TMD	PS	GPD	IPP	PES	AOL	EGS
TOP ÍNDICE	36.971	6.839	8.656	20.593	13.754	-7.038	2.207	4.383	1.617
	0.5%	12%	2%	2%	0.5%	38%	0.1%	0.1%	8%



Avaliação por Ultrassonografia										
AOL (cm ²)			ACABAMENTO (mm)			MARMOREIO (%)			ÍNDICE	RANK
OBS	GRUPO	CLASSE	OBS	GRUPO	CLASSE	OBS	GRUPO	CLASSE		
90.44	Superior	103	8.25	Superior	118	1.99	Superior	102	106.62	5



FAZENDA NOVA PARANAPANEMA

22

DISFER FNP

SEXO: MACHO - REG: FNP 7492 - RAÇA: NELORE PO - NASC.: 04/09/2022
 PESO: 655 KG - PE: 37.5 CM

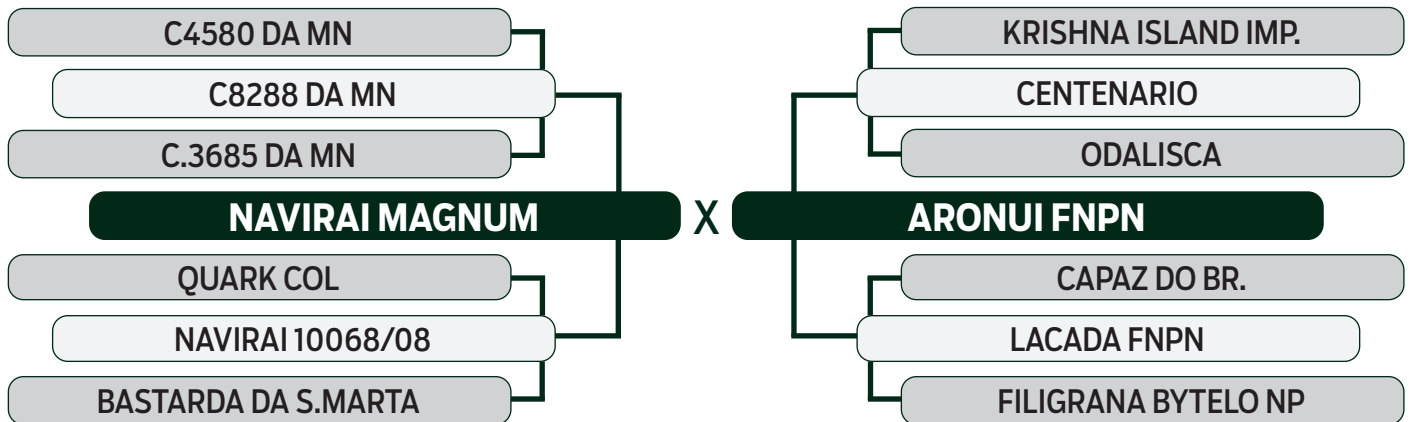

	iABCZ	PD-ED	PS-ED	PM-EM	TMD	IPP	STAY	PE-365	AOL	ACAB	MAR	M
DECA ÍNDICE	17.01	7.45	16.05	1.65	6.27	-14.85	37.50	0.519	2.388	0.378	-0.27	4.192
	1	1	1	2	1	2	1	2	1	4	7	1



	IQG	PD	TMD	PS	GPD	IPP	PES	AOL	EGS
TOP ÍNDICE	22.580	7.451	6.269	16.046	8.595	-14.848	0.883	2.387	0.378
	6%	9%	8%	6%	6%	15%	14%	6%	38%



Avaliação por Ultrassonografia										
AOL (cm ²)			ACABAMENTO (mm)			MARMOREIO (%)			ÍNDICE	RANK
OBS	GRUPO	CLASSE	OBS	GRUPO	CLASSE	OBS	GRUPO	CLASSE		
89.57	Superior	102	5.85	Regular	84	1.59	Regular	81	97.85	25



FAZENDA NOVA PARANAPANEMA

23

DIRIGENTE FNP

SEXO: MACHO - REG: FNP 7451 - RAÇA: NELORE PO - NASC.: 10/08/2022
 PESO: 640 KG - PE: 39.5 CM

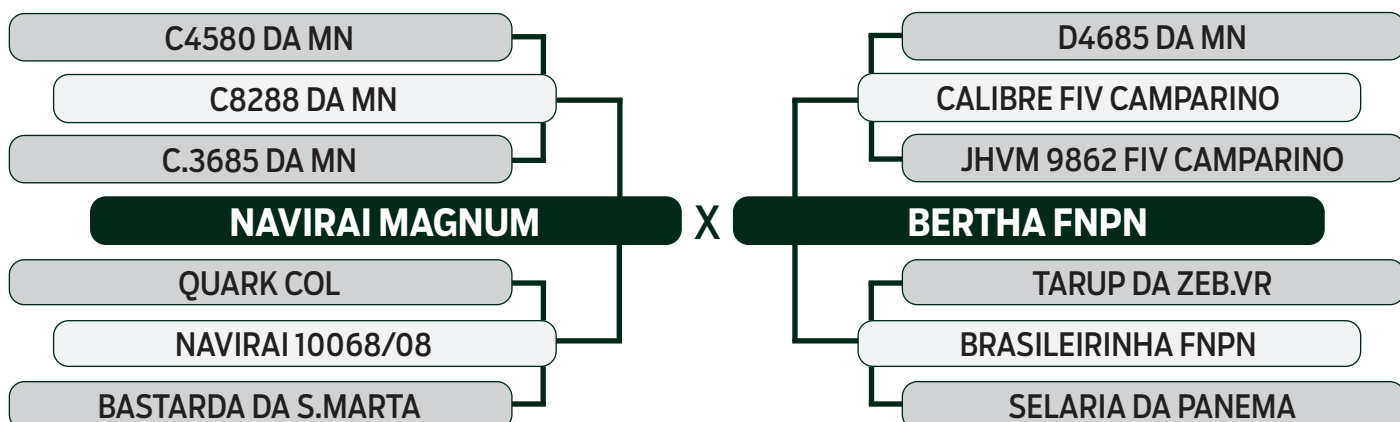

	iABCZ	PD-ED	PS-ED	PM-EM	TMD	IPP	STAY	PE-365	AOL	ACAB	MAR	M
DECA ÍNDICE	12.23	9.00	12.10	0.04	5.37	-2.30	33.60	1.153	2.153	2.209	-0.11	4.623
	1	1	1	6	1	5	3	1	1	1	6	1



	IQG	PD	TMD	PS	GPD	IPP	PES	AOL	EGS
TOP ÍNDICE	16.484	8.998	5.370	12.101	3.102	-2.303	1.414	2.153	2.209
	15%	4%	13%	15%	40%	56%	3%	9%	3%



Avaliação por Ultrassonografia										
AOL (cm ²)			ACABAMENTO (mm)			MARMOREIO (%)			ÍNDICE	RANK
OBS	GRUPO	CLASSE	OBS	GRUPO	CLASSE	OBS	GRUPO	CLASSE		
95.53	Superior	108	6.71	Regular	96	1.71	Regular	87	101.78	15



FAZENDA NOVA PARANAPANEMA

25

DIFUSOR FNP

SEXO: MACHO - REG: FNP 7529 - RAÇA: NELORE PO - NASC.: 19/09/2022
PESO: 583 KG - PE: 34.5 CM

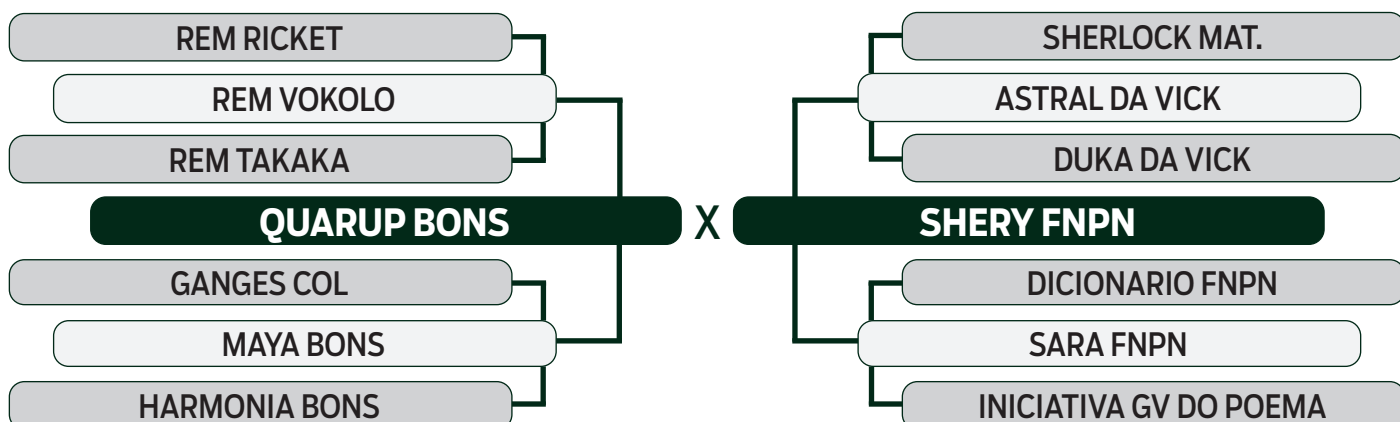

	iABCZ	PD-ED	PS-ED	PM-EM	TMD	IPP	STAY	PE-365	AOL	ACAB	MAR	M
DECA ÍNDICE	21.98	6.81	17.04	3.42	8.08	-18.58	40.48	1.517	1.314	2.036	-0.23	3.178
	1	1	1	1	1	1	1	1	2	1	6	1



	IQG	PD	TMD	PS	GPD	IPP	PES	AOL	EGS
TOP ÍNDICE	33.247	6.809	8.081	17.043	10.234	-18.582	1.369	1.314	2.036
	1%	12%	3%	5%	3%	8%	3%	24%	4%



Avaliação por Ultrassonografia										
AOL (cm ²)			ACABAMENTO (mm)			MARMOREIO (%)			ÍNDICE	RANK
OBS	GRUPO	CLASSE	OBS	GRUPO	CLASSE	OBS	GRUPO	CLASSE		
72.91	Inferior	83	8.10	Superior	116	2.25	Superior	114	99.63	19



FAZENDA NOVA PARANAPANEMA

26

DESVENDADO FNP

SEXO: MACHO - REG: FNP 7620 - RAÇA: NELORE PO - NASC.: 07/11/2022
PESO: 537 KG - PE: 34 CM

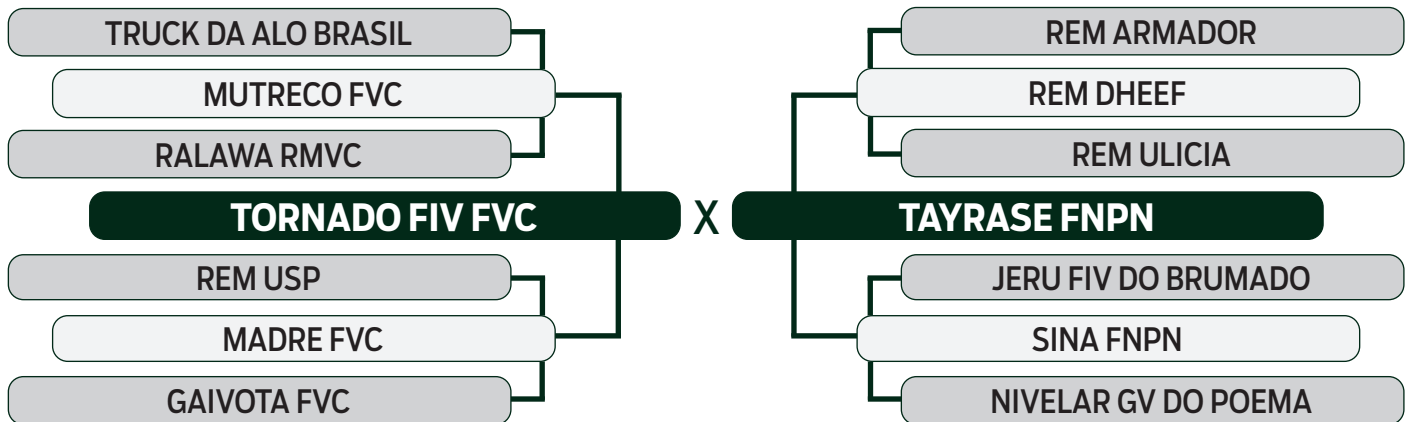

	iABCZ	PD-ED	PS-ED	PM-EM	TMD	IPP	STAY	PE-365	AOL	ACAB	MAR	M
DECA ÍNDICE	19.70	13.81	19.34	-1.24	4.50	-12.44	38.77	0.595	3.653	3.706	2.04	3.828
	1	1	1	9	2	2	1	1	1	1	1	1



	IQG	PD	TMD	PS	GPD	IPP	PES	AOL	EGS
TOP ÍNDICE	24.891	13.812	4.501	19.340	5.527	-12.438	0.900	3.653	3.706
	4%	0.5%	19%	2%	21%	20%	13%	1%	0.1%



Avaliação por Ultrassonografia										
AOL (cm ²)			ACABAMENTO (mm)			MARMOREIO (%)			ÍNDICE	RANK
OBS	GRUPO	CLASSE	OBS	GRUPO	CLASSE	OBS	GRUPO	CLASSE		
86.30	Regular	98	7.14	Superior	102	1.75	Regular	89	100.60	18



FAZENDA NOVA PARANAPANEMA

27

DOUTORO FNP

SEXO: MACHO - REG: FNP 7667 - RAÇA: NELORE PO - NASC.: 21/11/2022
 PESO: 522 KG - PE: 31.5 CM

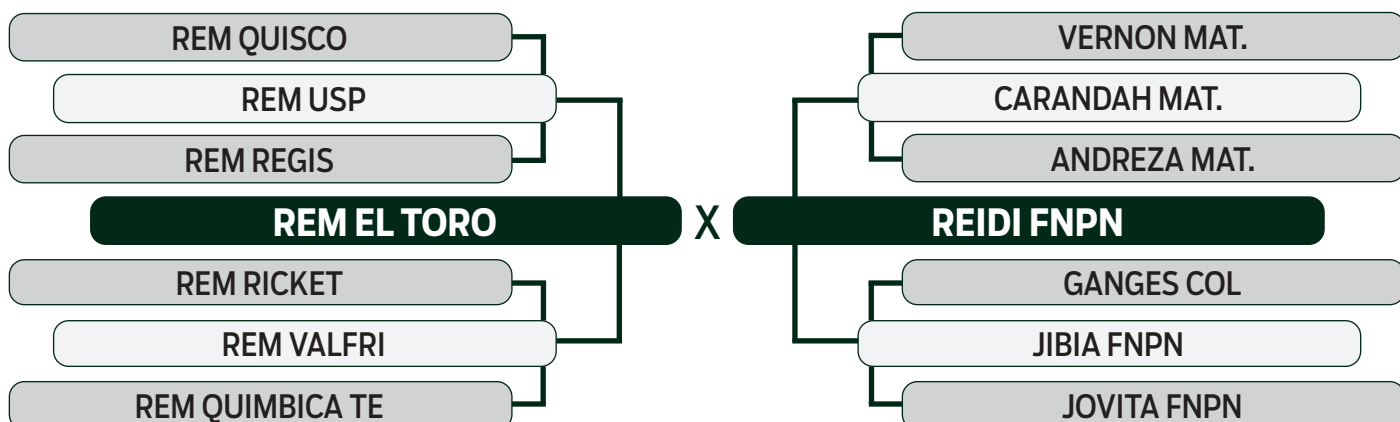

	iABCZ	PD-ED	PS-ED	PM-EM	TMD	IPP	STAY	PE-365	AOL	ACAB	MAR	M
DECA ÍNDICE	21.47	10.67	15.14	2.89	8.50	-17.08	40.53	0.867	2.615	3.070	-0.56	4.310
	1	1	1	1	1	1	1	1	1	1	8	1



	IQG	PD	TMD	PS	GPD	IPP	PES	AOL	EGS
TOP ÍNDICE	31.329	10.665	8.496	15.139	4.474	-17.077	1.104	2.615	3.070
	1%	2%	2%	7%	28%	10%	7%	5%	0.5%



Avaliação por Ultrassonografia										
AOL (cm ²)			ACABAMENTO (mm)			MARMOREIO (%)			ÍNDICE	RANK
OBS	GRUPO	CLASSE	OBS	GRUPO	CLASSE	OBS	GRUPO	CLASSE		
80.53	Regular	91	5.19	Inferior	74	1.53	Inferior	78	90.28	34



FAZENDA NOVA PARANAPANEMA

28

7804 DA FNPN

SEXO: MACHO - REG: FNPN 7804 - RAÇA: NELORE PO - NASC.: 10/01/2023
 PESO: 556 KG - PE: 30 CM

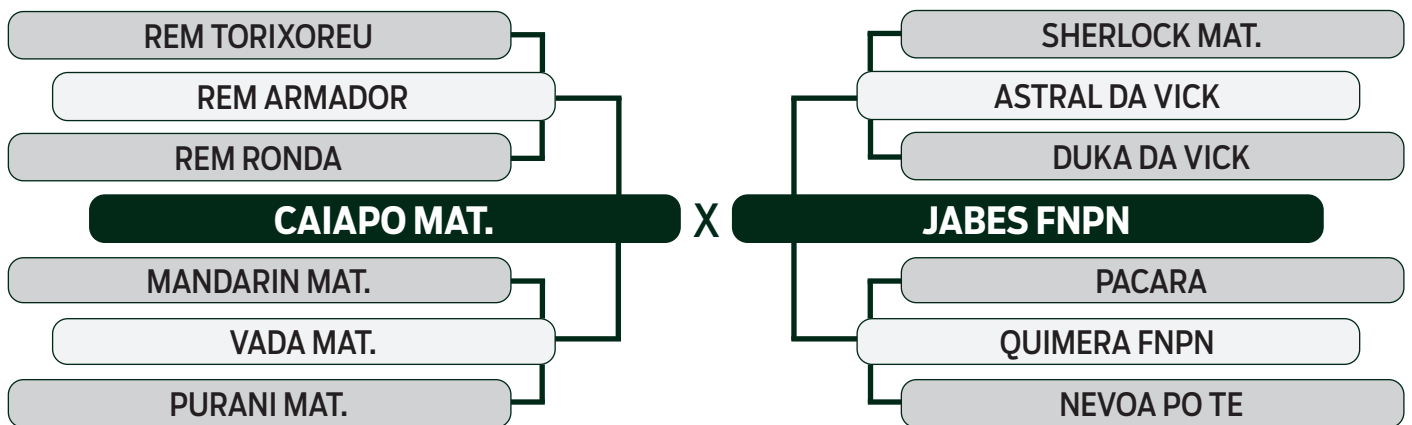

	iABCZ	PD-ED	PS-ED	PM-EM	TMD	IPP	STAY	PE-365	AOL	ACAB	MAR	M
DECA. ÍNDICE	19.33	9.59	17.79	-0.65	4.37	-19.60	40.07	0.394	4.249	1.653	-0.57	2.532
	1	1	1	7	2	1	1	3	1	1	8	1



	IQG	PD	TMD	PS	GPD	IPP	PES	AOL	EGS
TOP. ÍNDICE	24.060	9.588	4.369	17.793	8.204	-19.599	0.598	4.249	1.653
	5%	3%	20%	4%	8%	7%	26%	0.5%	7%



Avaliação por Ultrassonografia										
AOL (cm ²)			ACABAMENTO (mm)			MARMOREIO (%)			ÍNDICE	RANK
OBS	GRUPO	CLASSE	OBS	GRUPO	CLASSE	OBS	GRUPO	CLASSE		
104.33	Elite	118	5.94	Regular	85	1.68	Regular	86	103.21	12



FAZENDA NOVA PARANAPANEMA

29

7730 DA FNPN

SEXO: MACHO - REG: FNPN 7730 - RAÇA: NELORE PO - NASC.: 12/12/2022
 PESO: 500 KG - PE: 32 CM

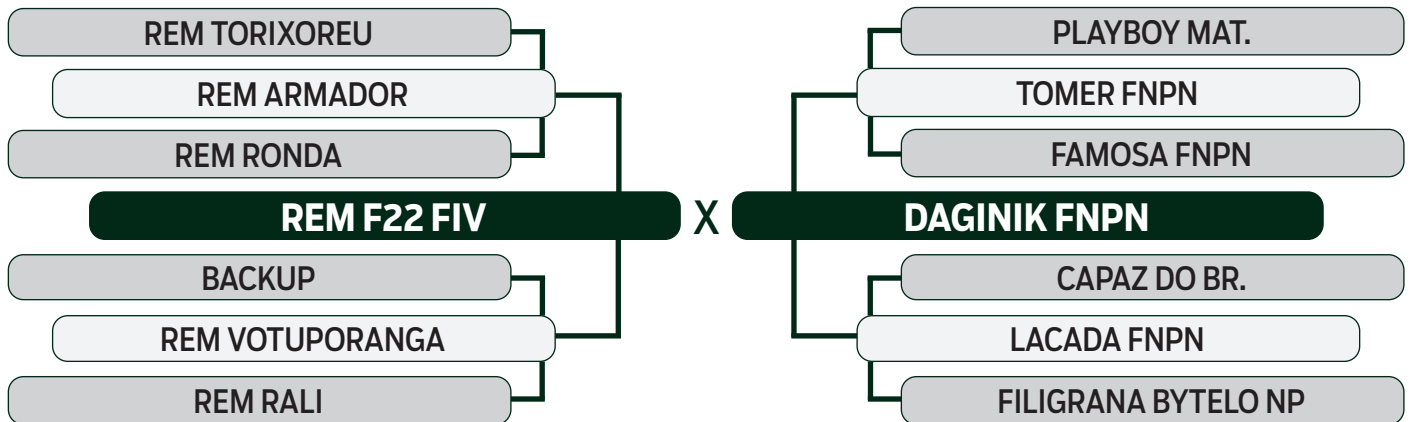

	iABCZ	PD-ED	PS-ED	PM-EM	TMD	IPP	STAY	PE-365	AOL	ACAB	MAR	M
DECA ÍNDICE	26.13	9.07	24.35	1.91	7.71	-30.48	41.78	0.863	1.514	4.405	0.39	3.306
	1	1	1	2	1	1	1	1	2	1	4	1



	IQG	PD	TMD	PS	GPD	IPP	PES	AOL	EGS
TOP ÍNDICE	36.043	9.069	7.712	24.351	15.282	-30.475	1.221	1.514	4.405
	0.5%	4%	4%	0.5%	0.1%	0.5%	5%	20%	0.1%



Avaliação por Ultrassonografia										
AOL (cm ²)			ACABAMENTO (mm)			MARMOREIO (%)			ÍNDICE	RANK
OBS	GRUPO	CLASSE	OBS	GRUPO	CLASSE	OBS	GRUPO	CLASSE		
82.18	Regular	93	6.75	Regular	97	2.29	Superior	117	98.29	23



FAZENDA NOVA PARANAPANEMA

30

DIURNO FNP

SEXO: MACHO - REG: FNP 7614 - RAÇA: NELORE PO - NASC.: 06/11/2022
 PESO: 534 KG - PE: 32.5 CM

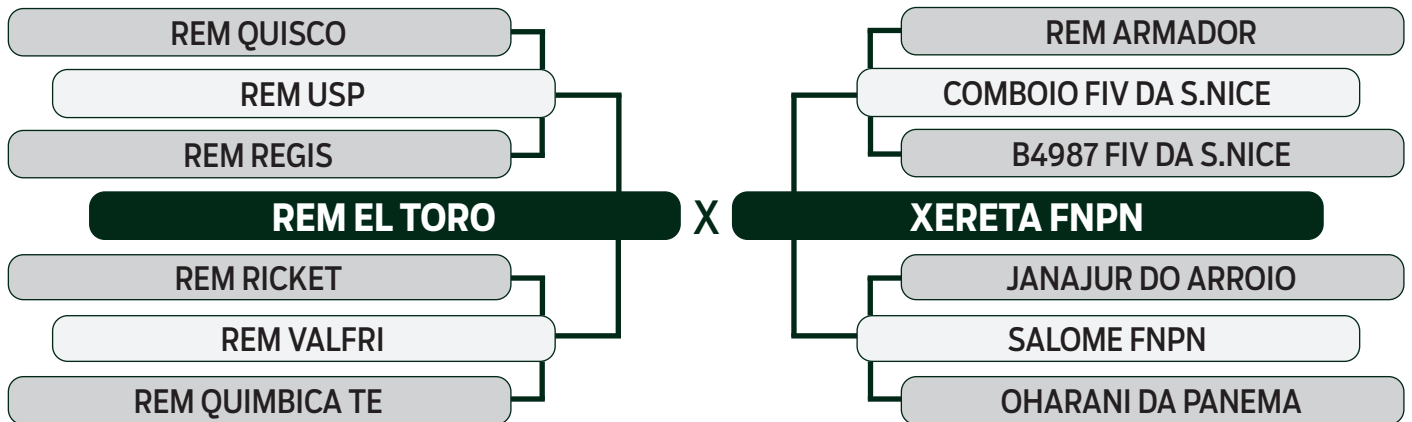

	iABCZ	PD-ED	PS-ED	PM-EM	TMD	IPP	STAY	PE-365	AOL	ACAB	MAR	M
DECA ÍNDICE	11.73	4.53	9.78	1.46	5.59	-8.95	34.70	0.873	1.441	1.159	-0.03	1.386
	2	2	2	3	1	3	2	1	2	2	5	3



	IQG	PD	TMD	PS	GPD	IPP	PES	AOL	EGS
TOP ÍNDICE	21.880	4.534	5.589	9.775	5.241	-8.947	1.225	1.441	1.159
	7%	28%	12%	23%	23%	31%	5%	21%	15%



Avaliação por Ultrassonografia										
AOL (cm ²)			ACABAMENTO (mm)			MARMOREIO (%)			ÍNDICE	RANK
OBS	GRUPO	CLASSE	OBS	GRUPO	CLASSE	OBS	GRUPO	CLASSE		
73.88	Inferior	84	5.19	Inferior	74	1.64	Regular	83	88.70	35



FAZENDA NOVA PARANAPANEMA

31

SPARTACUS FNP

SEXO: MACHO - REG: FNP 7713 - RAÇA: NELORE PO - NASC.: 09/12/2022
 PESO: 457 KG - PE: 29 CM

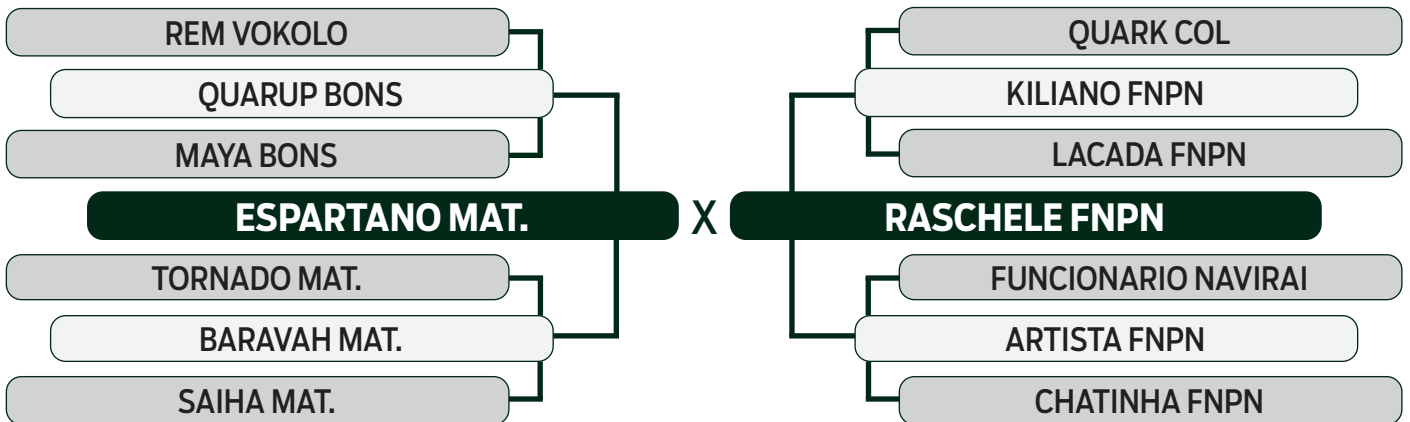

	iABCZ	PD-ED	PS-ED	PM-EM	TMD	IPP	STAY	PE-365	AOL	ACAB	MAR	M
DECA ÍNDICE	17.77	7.34	12.41	0.03	3.12	-24.60	39.22	0.973	3.794	2.357	-1.34	2.640
	1	1	1	6	3	1	1	1	1	1	10	1



	IQG	PD	TMD	PS	GPD	IPP	PES	AOL	EGS
TOP ÍNDICE	23.920	7.335	3.121	12.413	5.078	-24.600	0.776	3.794	2.356
	5%	9%	32%	14%	24%	3%	18%	0.5%	2%



Avaliação por Ultrassonografia										
AOL (cm ²)			ACABAMENTO (mm)			MARMOREIO (%)			ÍNDICE	RANK
OBS	GRUPO	CLASSE	OBS	GRUPO	CLASSE	OBS	GRUPO	CLASSE		
94.40	Superior	107	6.84	Regular	98	2.04	Superior	104	99.17	21



FAZENDA NOVA PARANAPANEMA

32

7791 DA FNPN

SEXO: MACHO - REG: FNPN 7791 - RAÇA: NELORE PO - NASC.: 31/12/2022
 PESO: 483 KG - PE: 26 CM

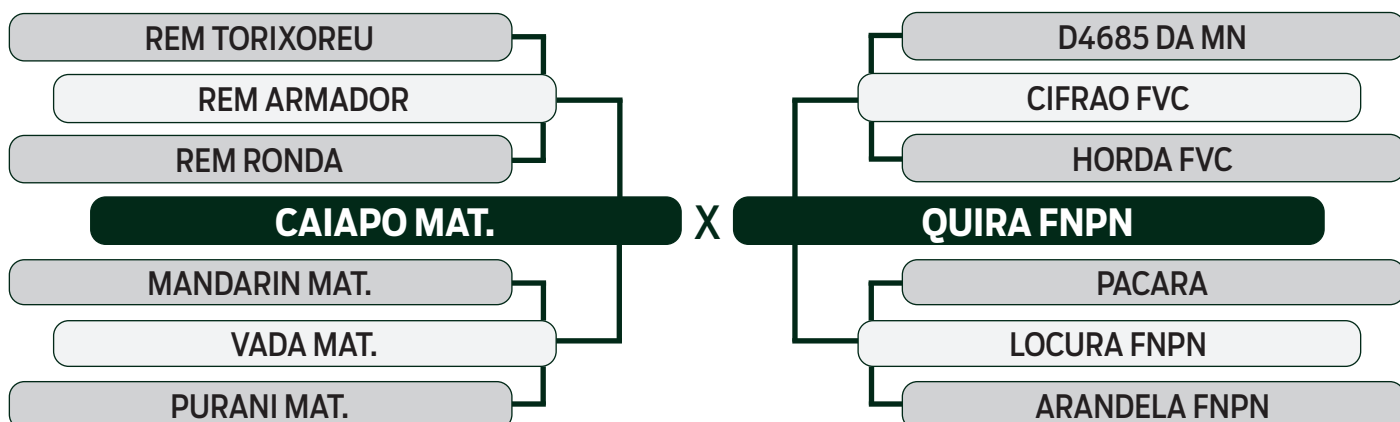

	iABCZ	PD-ED	PS-ED	PM-EM	TMD	IPP	STAY	PE-365	AOL	ACAB	MAR	M
DECA ÍNDICE	15.77	9.44	14.37	1.03	6.23	2.34	40.66	0.073	0.779	1.360	0.62	4.461
	1	1	1	3	1	7	1	5	4	1	3	1



	IQG	PD	TMD	PS	GPD	IPP	PES	AOL	EGS
TOP ÍNDICE	19.002	9.445	6.229	14.374	4.929	2.342	0.177	0.779	1.360
	11%	3%	8%	9%	25%	73%	52%	39%	12%



Avaliação por Ultrassonografia										
AOL (cm ²)			ACABAMENTO (mm)			MARMOREIO (%)			ÍNDICE	RANK
OBS	GRUPO	CLASSE	OBS	GRUPO	CLASSE	OBS	GRUPO	CLASSE		
87.26	Regular	99	7.47	Superior	107	1.44	Inferior	74	100.72	17



FAZENDA NOVA PARANAPANEMA

33

DENOTADO FNP

SEXO: MACHO - REG: FNP 7716 - RAÇA: NELORE PO - NASC.: 11/12/2022
PESO: 549 KG - PE: 35 CM

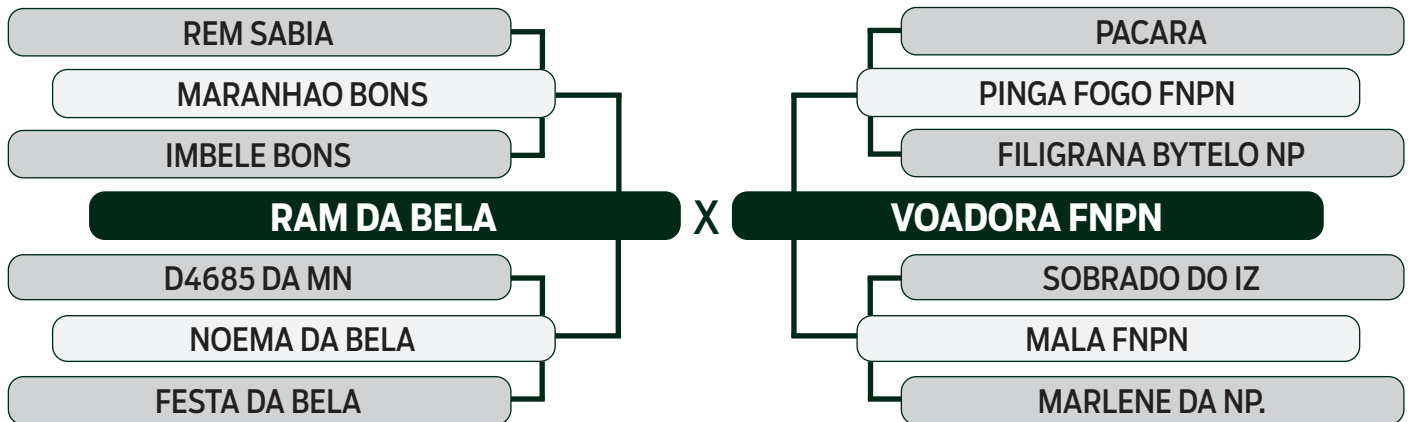

	iABCZ	PD-ED	PS-ED	PM-EM	TMD	IPP	STAY	PE-365	AOL	ACAB	MAR	M
DECA ÍNDICE	20.38	5.20	13.81	1.81	5.75	-13.67	44.96	0.980	1.420	0.377	2.71	3.469
	1	2	1	2	1	2	1	1	2	4	1	1



	IQG	PD	TMD	PS	GPD	IPP	PES	AOL	EGS
TOP ÍNDICE	29.566	5.195	5.749	13.807	8.611	-13.671	1.370	1.420	0.377
	2%	22%	11%	10%	6%	17%	3%	22%	38%



Avaliação por Ultrassonografia										
AOL (cm ²)			ACABAMENTO (mm)			MARMOREIO (%)			ÍNDICE	RANK
OBS	GRUPO	CLASSE	OBS	GRUPO	CLASSE	OBS	GRUPO	CLASSE		
90.69	Superior	103	7.84	Superior	112	2.85	Elite	145	105.16	8



FAZENDA NOVA PARANAPANEMA

34

7747 DA FNPN

SEXO: MACHO - REG: FNPN 7747 - RAÇA: NELORE PO - NASC.: 15/12/2022
 PESO: 469 KG - PE: 30.5 CM

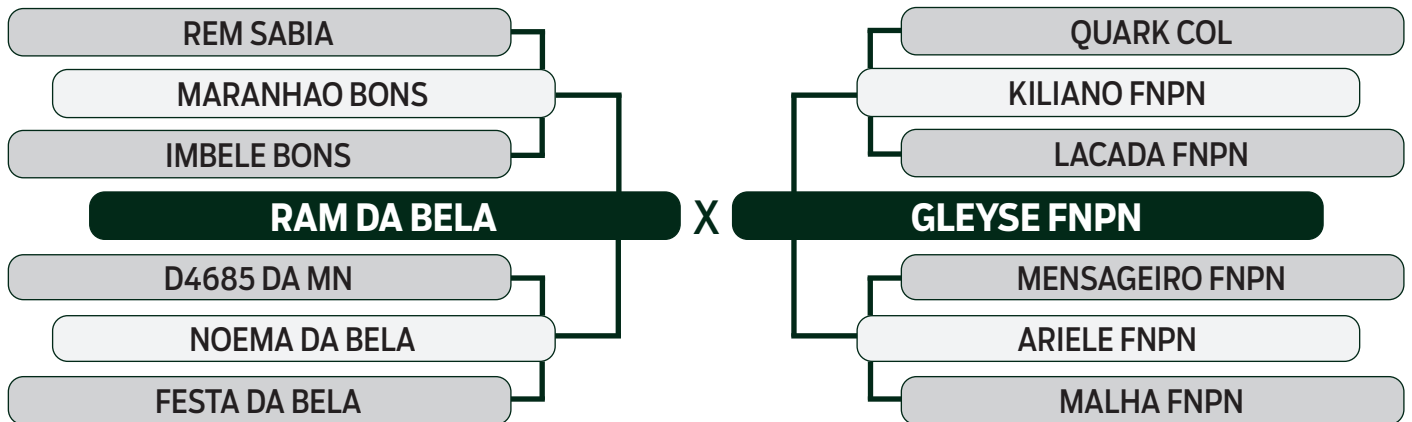

	iABCZ	PD-ED	PS-ED	PM-EM	TMD	IPP	STAY	PE-365	AOL	ACAB	MAR	M
DECA ÍNDICE	16.98	3.06	9.92	3.08	6.44	-14.37	41.79	0.721	0.310	-0.094	1.01	3.800
	1	4	2	1	1	2	1	1	5	6	2	1



	IQG	PD	TMD	PS	GPD	IPP	PES	AOL	EGS
TOP ÍNDICE	24.701	3.060	6.444	9.920	6.859	-14.369	0.756	0.310	-0.095
	4%	42%	7%	23%	13%	16%	19%	53%	55%



Avaliação por Ultrassonografia										
AOL (cm ²)			ACABAMENTO (mm)			MARMOREIO (%)			ÍNDICE	RANK
OBS	GRUPO	CLASSE	OBS	GRUPO	CLASSE	OBS	GRUPO	CLASSE		
73.07	Inferior	83	5.45	Inferior	78	1.78	Regular	91	87.53	37



FAZENDA NOVA PARANAPANEMA

35

7784 DA FNPN

SEXO: MACHO - REG: FNPN 7784 - RAÇA: NELORE PO - NASC.: 29/12/2022
 PESO: 526 KG - PE: 28 CM

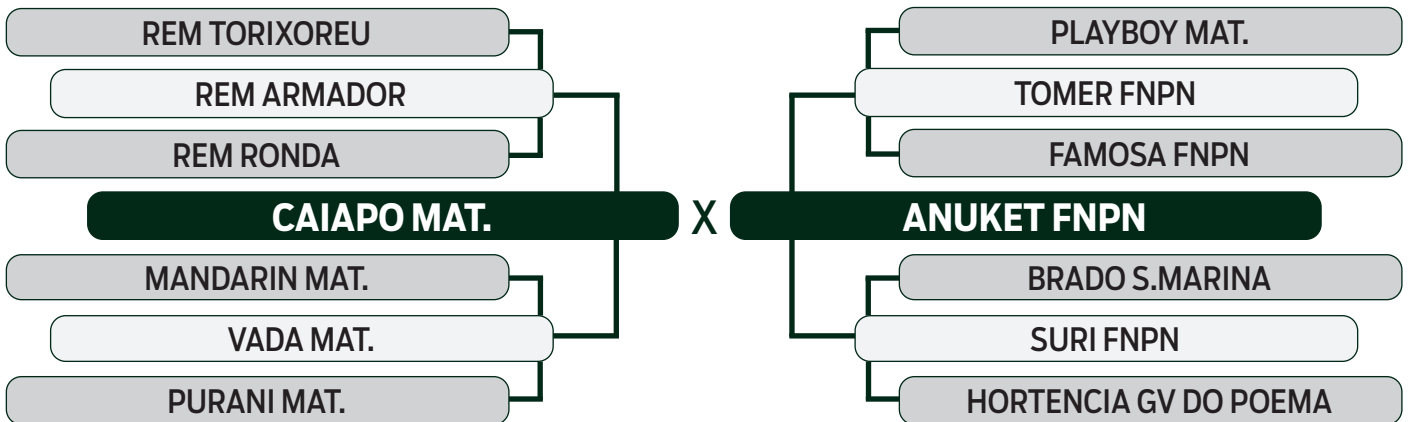

	iABCZ	PD-ED	PS-ED	PM-EM	TMD	IPP	STAY	PE-365	AOL	ACAB	MAR	M
DECA ÍNDICE	20.72	10.49	19.16	3.00	9.69	-7.40	40.26	0.158	1.726	-0.150	1.85	4.448
	1	1	1	1	1	3	1	5	1	6	1	1



	IQG	PD	TMD	PS	GPD	IPP	PES	AOL	EGS
TOP ÍNDICE	24.775	10.494	9.694	19.162	8.668	-7.395	0.051	1.726	-0.150
	4%	2%	1%	3%	6%	37%	61%	15%	57%



Avaliação por Ultrassonografia										
AOL (cm ²)			ACABAMENTO (mm)			MARMOREIO (%)			ÍNDICE	RANK
OBS	GRUPO	CLASSE	OBS	GRUPO	CLASSE	OBS	GRUPO	CLASSE		
75.94	Inferior	86	6.09	Regular	87	1.73	Regular	88	94.31	29



FAZENDA NOVA PARANAPANEMA

36

7623 DA FNPN

SEXO: MACHO - REG: FNPN 7623 - RAÇA: NELORE PO - NASC.: 07/11/2022
 PESO: 522 KG - PE: 31.5 CM

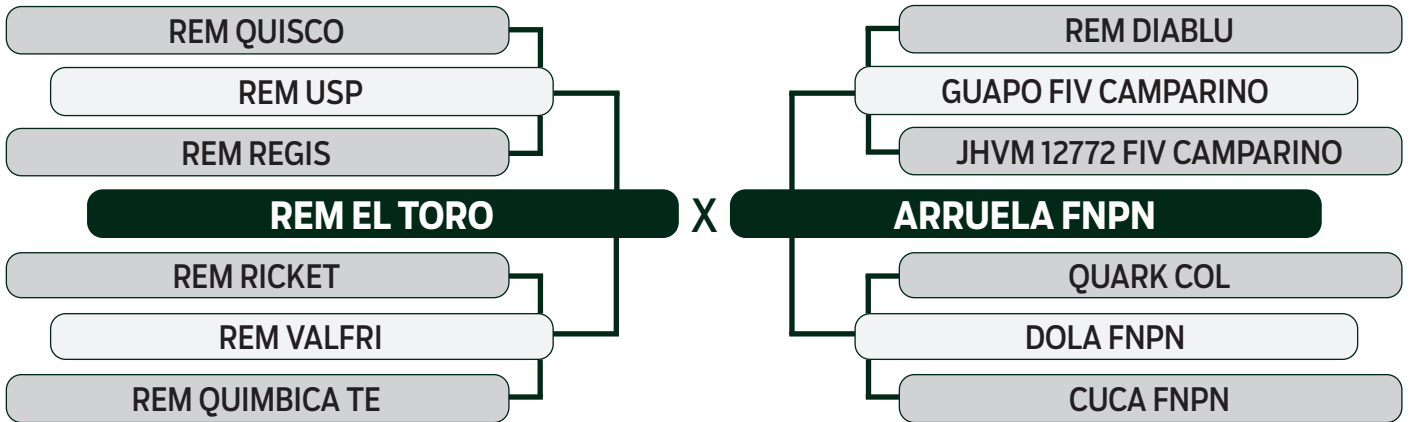

	iABCZ	PD-ED	PS-ED	PM-EM	TMD	IPP	STAY	PE-365	AOL	ACAB	MAR	M
DECA ÍNDICE	17.73	9.30	20.40	2.53	7.73	-11.16	34.72	0.756	3.260	1.849	0.37	2.054
	1	1	1	1	1	2	2	1	1	1	4	2



	IQG	PD	TMD	PS	GPD	IPP	PES	AOL	EGS
TOP ÍNDICE	27.728	9.302	7.732	20.395	11.093	-11.158	1.434	3.260	1.849
	3%	3%	4%	2%	2%	24%	3%	2%	5%



Avaliação por Ultrassonografia										
AOL (cm ²)			ACABAMENTO (mm)			MARMOREIO (%)			ÍNDICE	RANK
OBS	GRUPO	CLASSE	OBS	GRUPO	CLASSE	OBS	GRUPO	CLASSE		
81.90	Regular	93	5.63	Regular	81	1.63	Regular	83	90.75	33



FAZENDA NOVA PARANAPANEMA

37

7744 DA FNP

SEXO: MACHO - REG: FNP 7744 - RAÇA: NELORE PO - NASC.: 15/12/2022
 PESO: 516 KG - PE: 34 CM

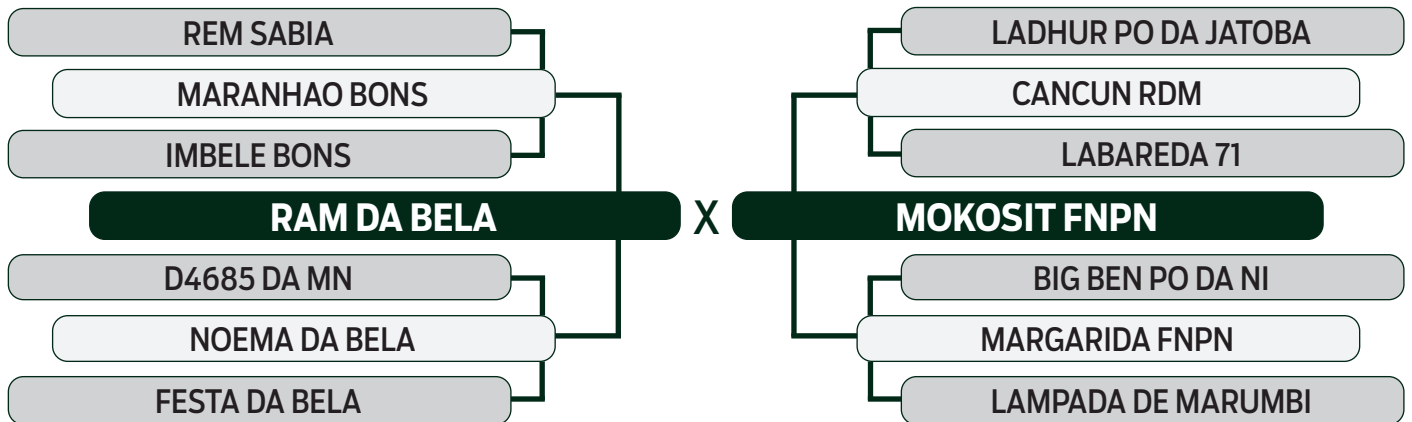

	iABCZ	PD-ED	PS-ED	PM-EM	TMD	IPP	STAY	PE-365	AOL	ACAB	MAR	M
DECA ÍNDICE	16.32	5.53	11.24	1.08	5.20	-12.83	39.60	1.144	0.425	1.602	2.08	1.221
	1	2	2	3	1	2	1	1	5	1	1	3



	IQG	PD	TMD	PS	GPD	IPP	PES	AOL	EGS
TOP ÍNDICE	22.150	5.533	5.197	11.243	5.711	-12.827	1.432	0.425	1.602
	7%	20%	14%	18%	19%	19%	3%	50%	8%



Avaliação por Ultrassonografia										
AOL (cm ²)			ACABAMENTO (mm)			MARMOREIO (%)			ÍNDICE	RANK
OBS	GRUPO	CLASSE	OBS	GRUPO	CLASSE	OBS	GRUPO	CLASSE		
84.66	Regular	96	7.66	Superior	110	1.59	Regular	81	103.78	10



NELORE VALE DA CEGONHA

38

TAPAJOS DNO

SEXO: MACHO - REG: DNO A3671 - RAÇA: NELORE PO - NASC.: 17/08/2022
 PESO: 637 KG - PE: 40 CM

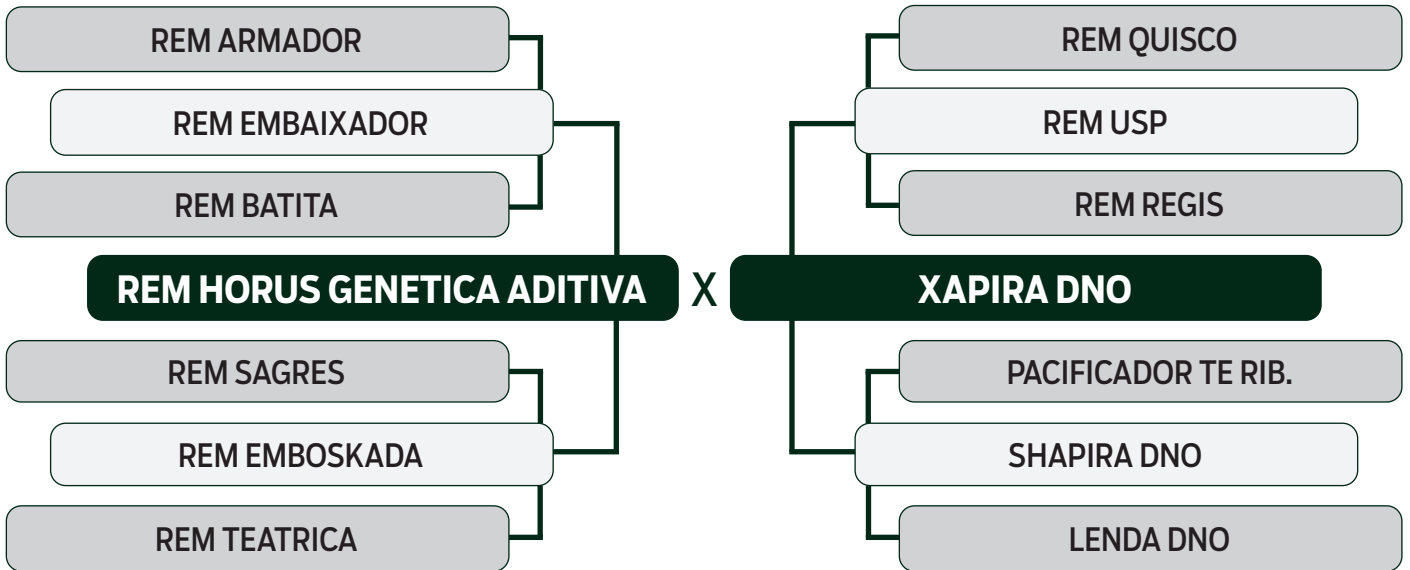

	iABCZ	PD-ED	PS-ED	PM-EM	TMD	IPP	STAY	PE-365	AOL	ACAB	MAR	M
DECA	14.86	4.94	12.66	5.49	8.06	-12.42	33.29	1.214	1.344	0.913	-0.01	2.530
INDICE	1	2	1	1	1	2	3	1	2	2	5	1



NELORE VALE DA CEGONHA

39

PATENO DNO

SEXO: MACHO - REG: DNO A3609 - RAÇA: NELORE PO - NASC.: 02/07/2022
 PESO: 685 KG - PE: 39 CM

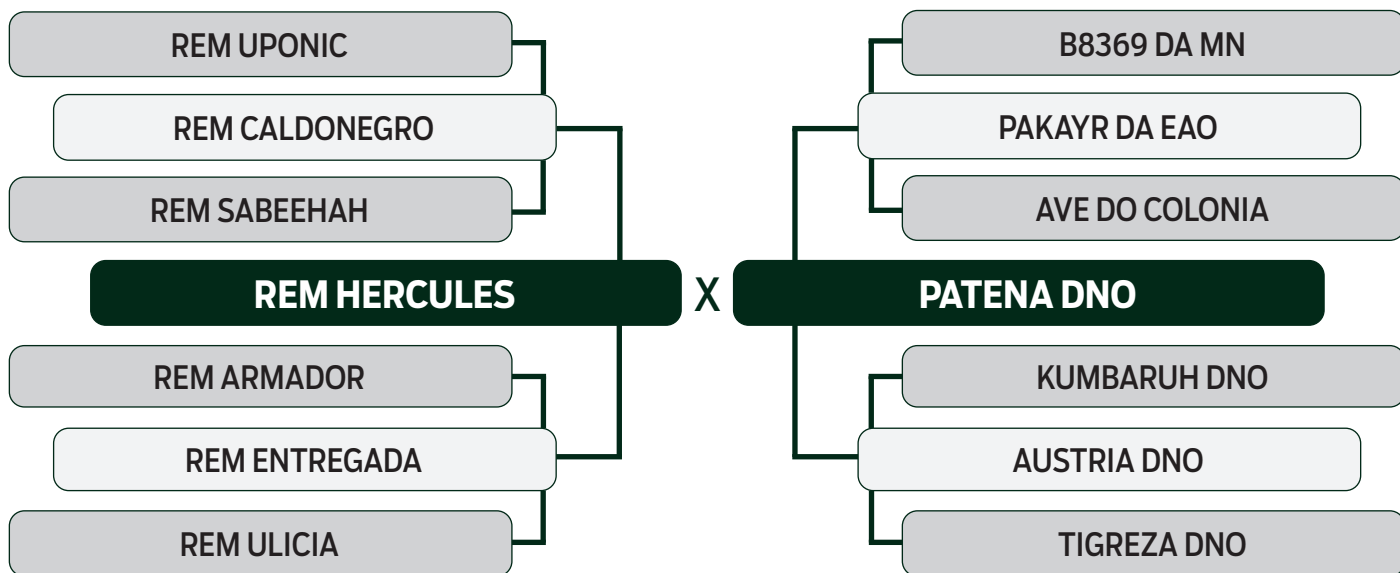

	iABCZ	PD-ED	PS-ED	PM-EM	TMD	IPP	STAY	PE-365	AOL	ACAB	MAR	M
DECA	25.08	12.41	29.71	1.08	8.06	-19.02	40.20	0.780	2.295	1.160	1.00	1.449
INDICE	1	1	1	3	1	1	1	1	1	2	2	3



NELORE VALE DA CEGONHA

40

TEJO DNO

SEXO: MACHO - REG: DNO A3622 - RAÇA: NELORE PO - NASC.: 16/07/2022
 PESO: 624 KG - PE: 39 CM

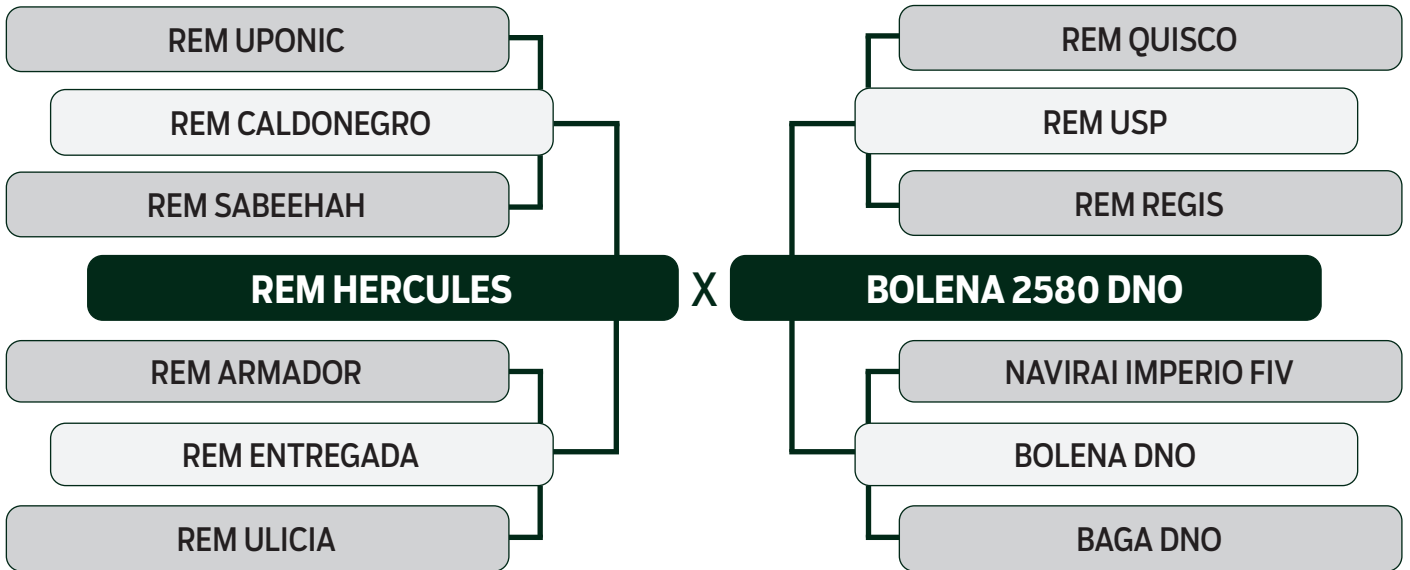

	iABCZ	PD-ED	PS-ED	PM-EM	TMD	IPP	STAY	PE-365	AOL	ACAB	MAR	M
DECA	26.06	13.55	27.40	1.03	7.84	-19.09	41.15	1.096	0.968	0.693	0.72	2.433
INDICE	1	1	1	3	1	1	1	1	3	3	2	1



NELORE VALE DA CEGONHA

41

DINESH DNO

SEXO: MACHO - REG: DNO A3616 - RAÇA: NELORE PO - NASC.: 07/07/2022
 PESO: 652 KG - PE: 37.5 CM

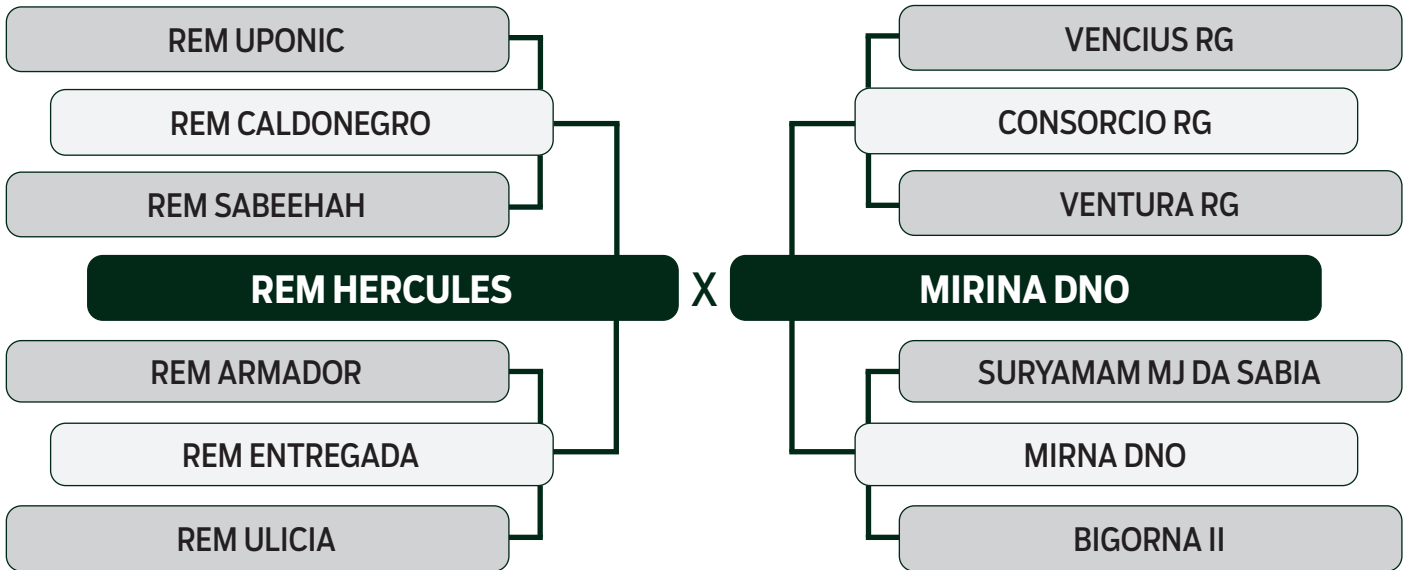

	iABCZ	PD-ED	PS-ED	PM-EM	TMD	IPP	STAY	PE-365	AOL	ACAB	MAR	M
DECA	25.03	13.66	26.17	1.54	8.64	-12.17	41.26	0.919	1.146	0.846	-0.03	1.315
INDICE	1	1	1	2	1	2	1	1	3	2	5	3



NELORE VALE DA CEGONHA

42

BRAZOS DNO

SEXO: MACHO - REG: DNO A3619 - RAÇA: NELORE PO - NASC.: 14/07/2022
 PESO: 622 KG - PE: 38 CM

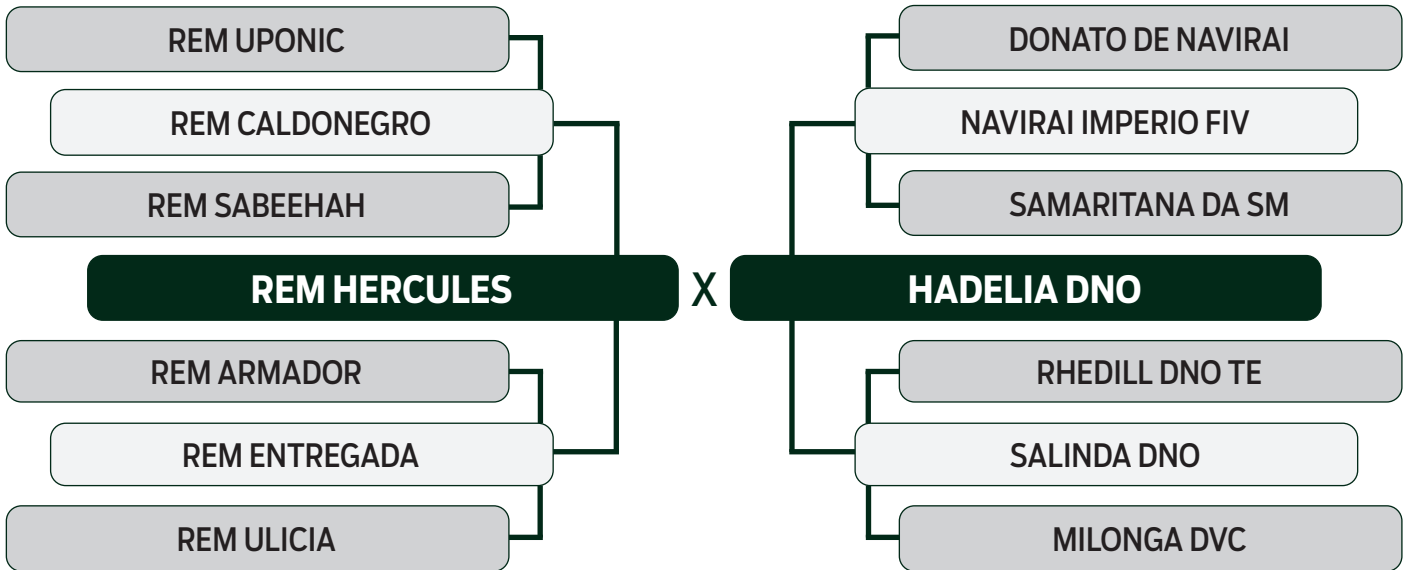

	iABCZ	PD-ED	PS-ED	PM-EM	TMD	IPP	STAY	PE-365	AOL	ACAB	MAR	M
DECA	21.65	11.75	24.12	0.24	5.74	-16.37	39.05	0.858	1.107	0.914	0.57	0.974
INDICE	1	1	1	5	1	1	1	1	3	2	3	4



NELORE VALE DA CEGONHA

43

MALTEZ DNO

SEXO: MACHO - REG: DNO A3605 - RAÇA: NELORE PO - NASC.: 29/06/2022
 PESO: 681 KG - PE: 37.5 CM

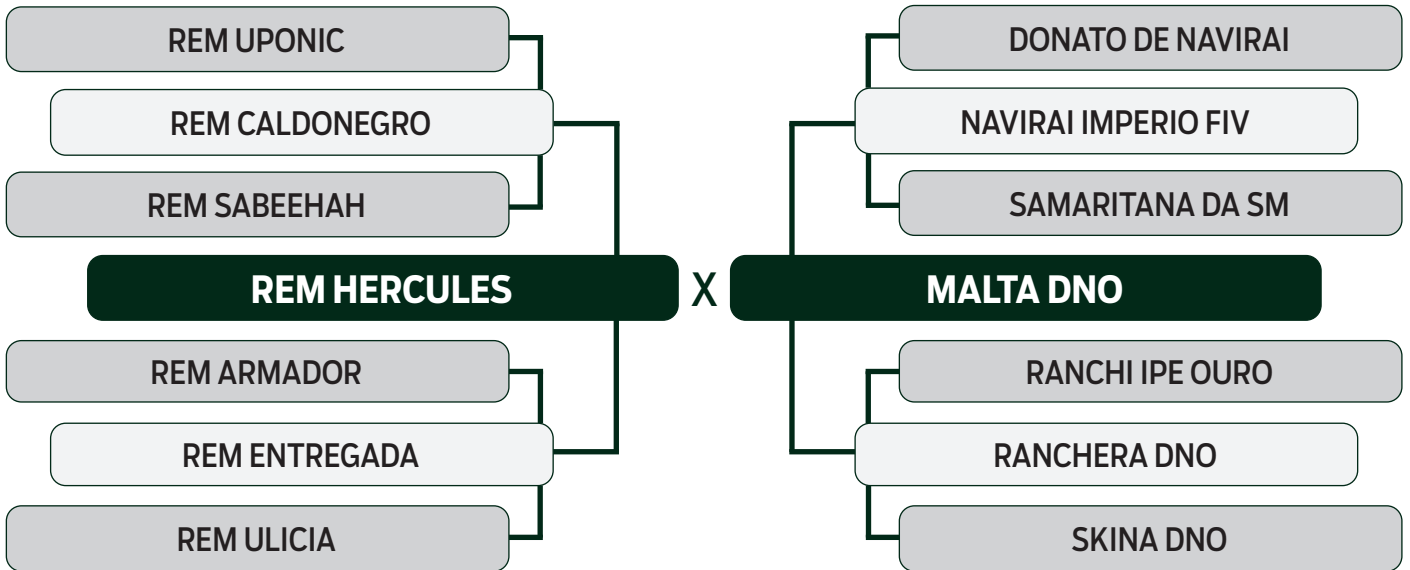

	iABCZ	PD-ED	PS-ED	PM-EM	TMD	IPP	STAY	PE-365	AOL	ACAB	MAR	M
DECA	22.20	13.53	25.21	0.37	6.96	-12.99	38.37	0.938	1.241	0.507	0.50	1.195
INDICE	1	1	1	5	1	1	1	1	2	3	3	3



NELORE VALE DA CEGONHA

44

MAKENZIE DNO

SEXO: MACHO - REG: DNO A3666 - RAÇA: NELORE PO - NASC.: 15/08/2022
 PESO: 614 KG - PE: 39.5 CM

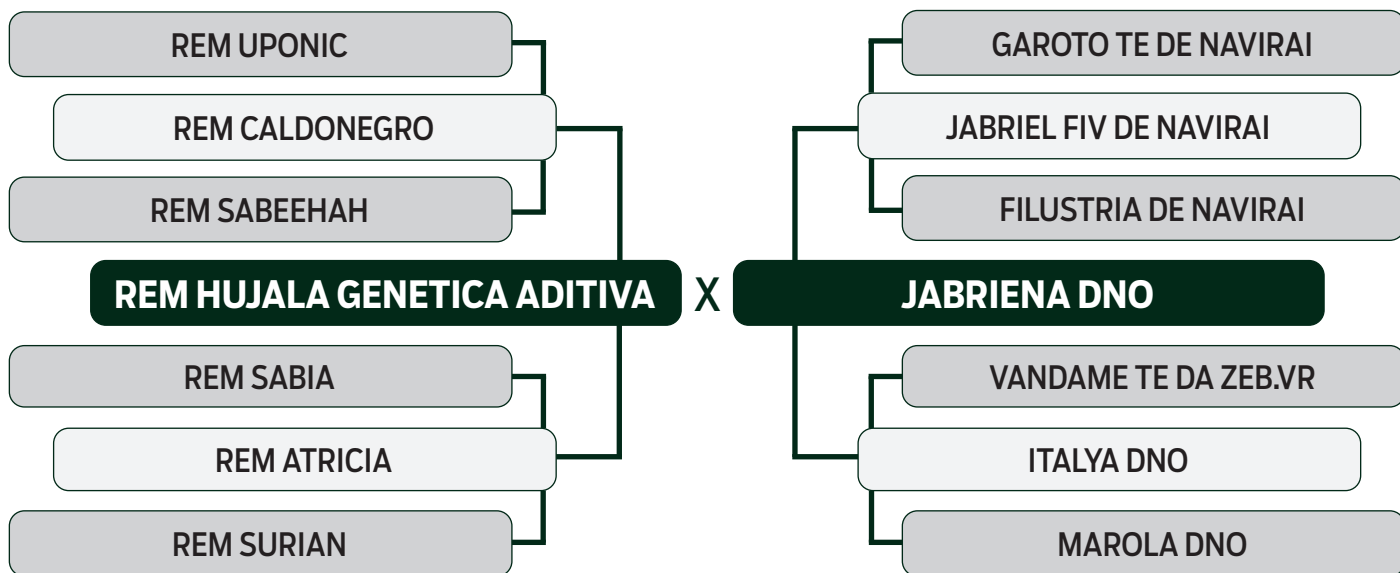

	iABCZ	PD-ED	PS-ED	PM-EM	TMD	IPP	STAY	PE-365	AOL	ACAB	MAR	M
DECA	18.18	10.36	20.85	1.31	7.22	-12.21	35.08	0.640	1.547	1.980	0.85	1.703
INDICE	1	1	1	3	1	2	2	1	2	1	2	2



NELORE VALE DA CEGONHA

45

RENO DNO

SEXO: MACHO - REG: DNO A3617 - RAÇA: NELORE PO - NASC.: 13/07/2022
 PESO: 573 KG - PE: 40 CM

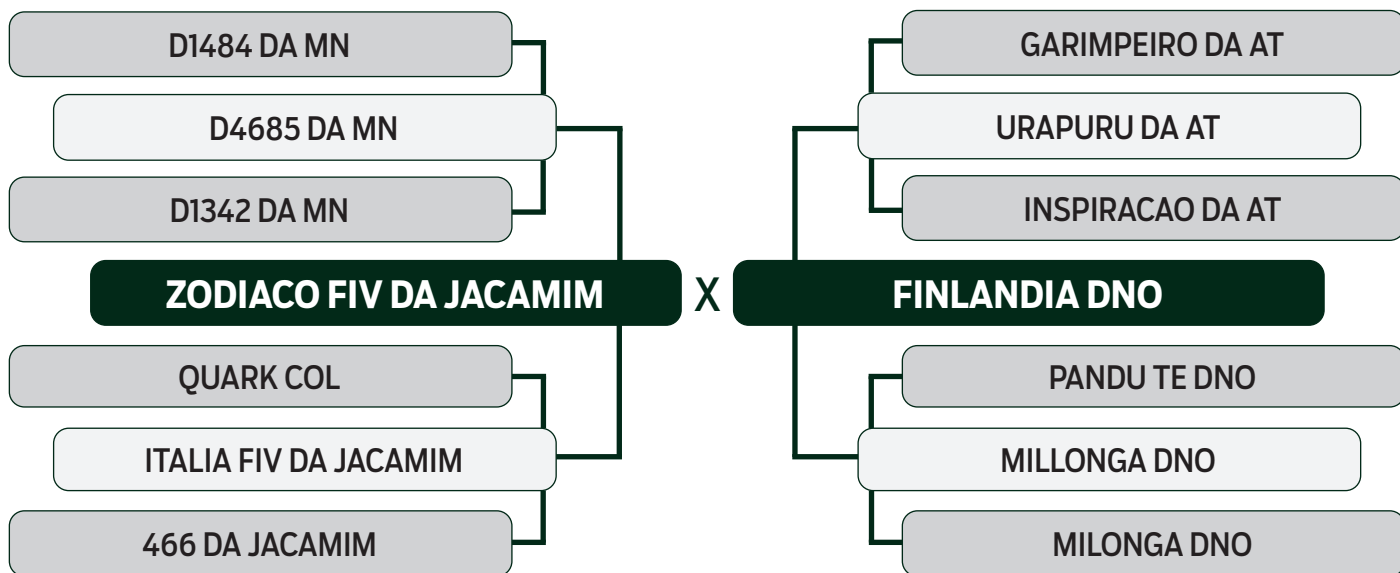

	iABCZ	PD-ED	PS-ED	PM-EM	TMD	IPP	STAY	PE-365	AOL	ACAB	MAR	M
DECA	11.67	1.81	11.49	3.00	5.40	-11.17	36.86	0.127	1.612	1.705	0.50	2.545
INDICE	2	5	2	1	1	2	1	5	2	1	3	1



NELORE VALE DA CEGONHA

46

CAFUNI DNO

SEXO: MACHO - REG: DNO A3701 - RAÇA: NELORE PO - NASC.: 21/09/2022
 PESO: 572 KG - PE: 33 CM

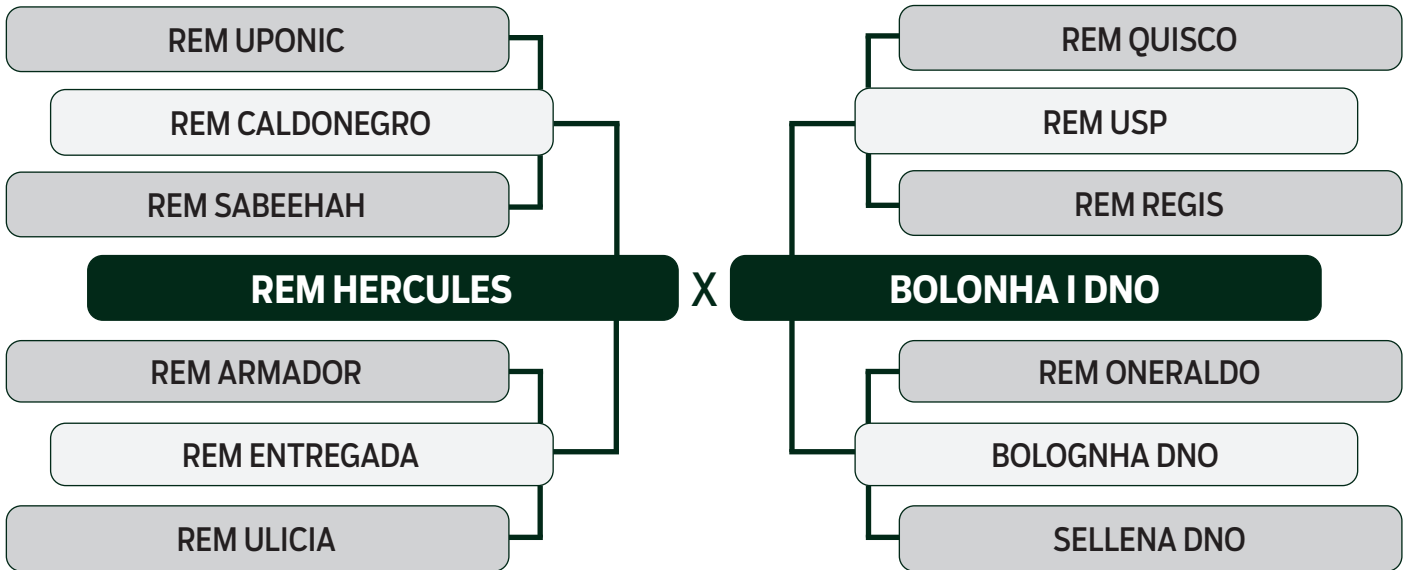

	iABCZ	PD-ED	PS-ED	PM-EM	TMD	IPP	STAY	PE-365	AOL	ACAB	MAR	M
DECA	27.64	13.22	24.06	2.22	9.31	-19.54	41.70	1.142	0.526	0.770	1.08	2.283
INDICE	1	1	1	1	1	1	1	1	4	3	1	2



NELORE VALE DA CEGONHA

47

ELANTRO DNO

SEXO: MACHO - REG: DNO A3686 - RAÇA: NELORE PO - NASC.: 15/09/2022
 PESO: 545 KG - PE: 36.5 CM

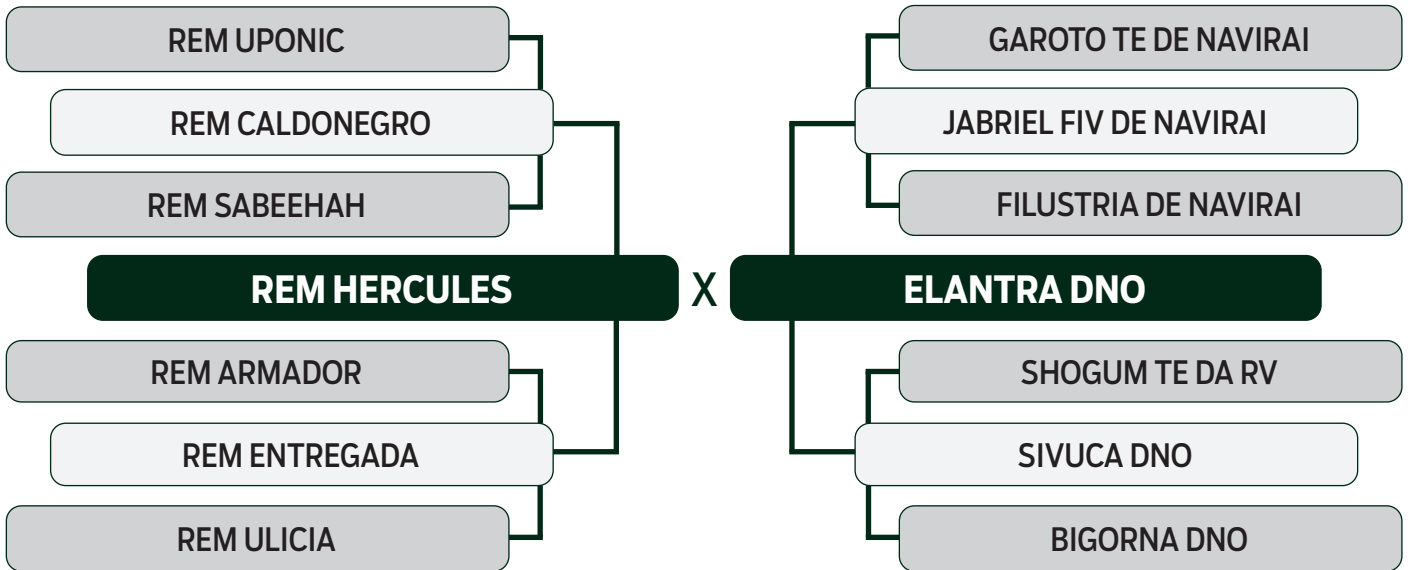

	iABCZ	PD-ED	PS-ED	PM-EM	TMD	IPP	STAY	PE-365	AOL	ACAB	MAR	M
DECA	24.81	14.27	31.73	0.98	8.35	-11.12	37.95	0.974	1.926	1.342	0.85	1.842
INDICE	1	1	1	4	1	2	1	1	1	1	2	2



NELORE VALE DA CEGONHA

48

HARGOS DNO

SEXO: MACHO - REG: DNO A3667 - RAÇA: NELORE PO - NASC.: 16/08/2022
 PESO: 619 KG - PE: 38 CM

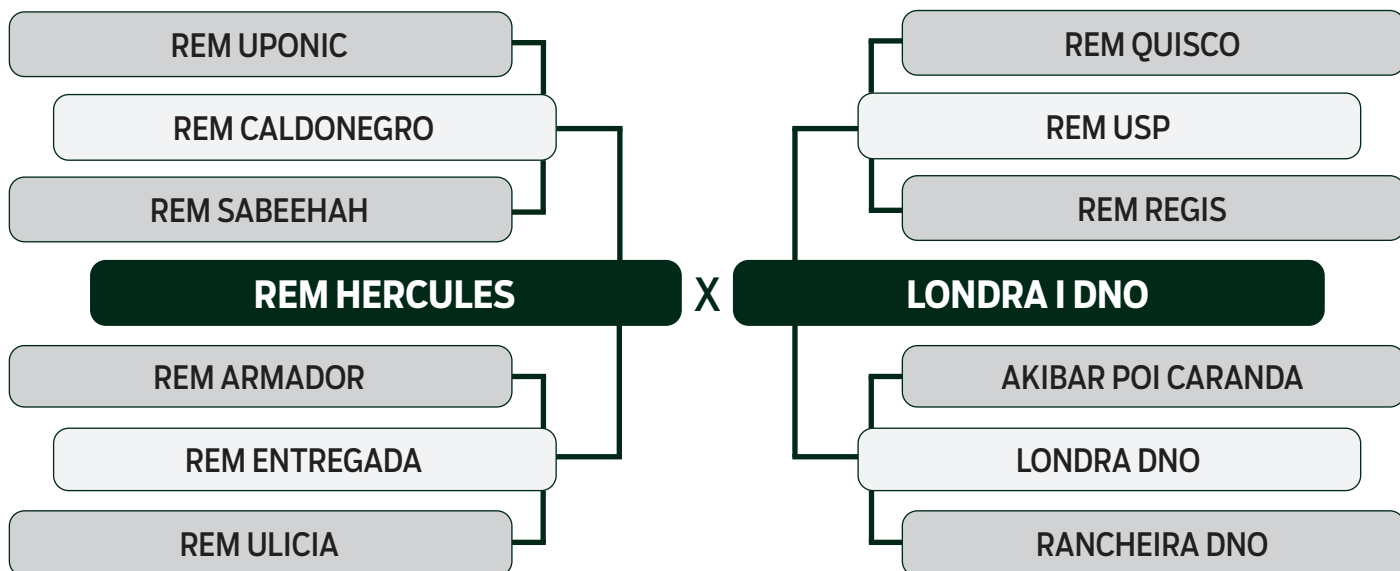

	iABCZ	PD-ED	PS-ED	PM-EM	TMD	IPP	STAY	PE-365	AOL	ACAB	MAR	M
DECA	27.56	13.91	29.73	1.49	8.75	-18.66	41.36	1.027	1.386	0.772	0.85	1.994
INDICE	1	1	1	3	1	1	1	1	2	3	2	2



FAZENDA SANTA FÉ

49

2730 WP

SEXO: MACHO - REG: NWP 2730 - RAÇA: NELORE PO - NASC.: 16/09/2022
 PESO: 538 KG - PE: 35 CM

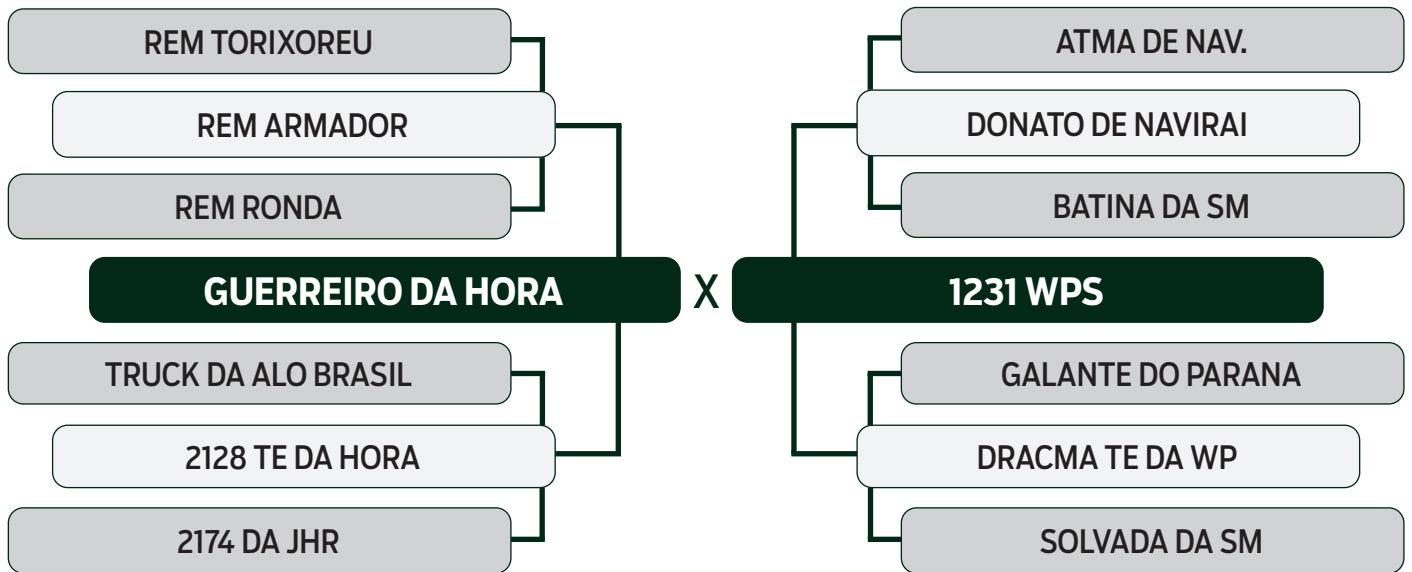

	iABCZ	PD-ED	PS-ED	PM-EM	TMD	IPP	STAY	PE-365	AOL	ACAB	MAR	M
DECA	15.17	8.70	16.14	2.66	7.54	-7.50	34.34	0.579	2.859	-0.034	1.02	2.771
INDICE	1	1	1	1	1	3	2	1	1	6	2	1



FAZENDA SANTA FÉ

50

2628 WP

SEXO: MACHO - REG: NWP 2628 - RAÇA: NELORE PO - NASC.: 12/07/2022
 PESO: 546 KG - PE: 36 CM

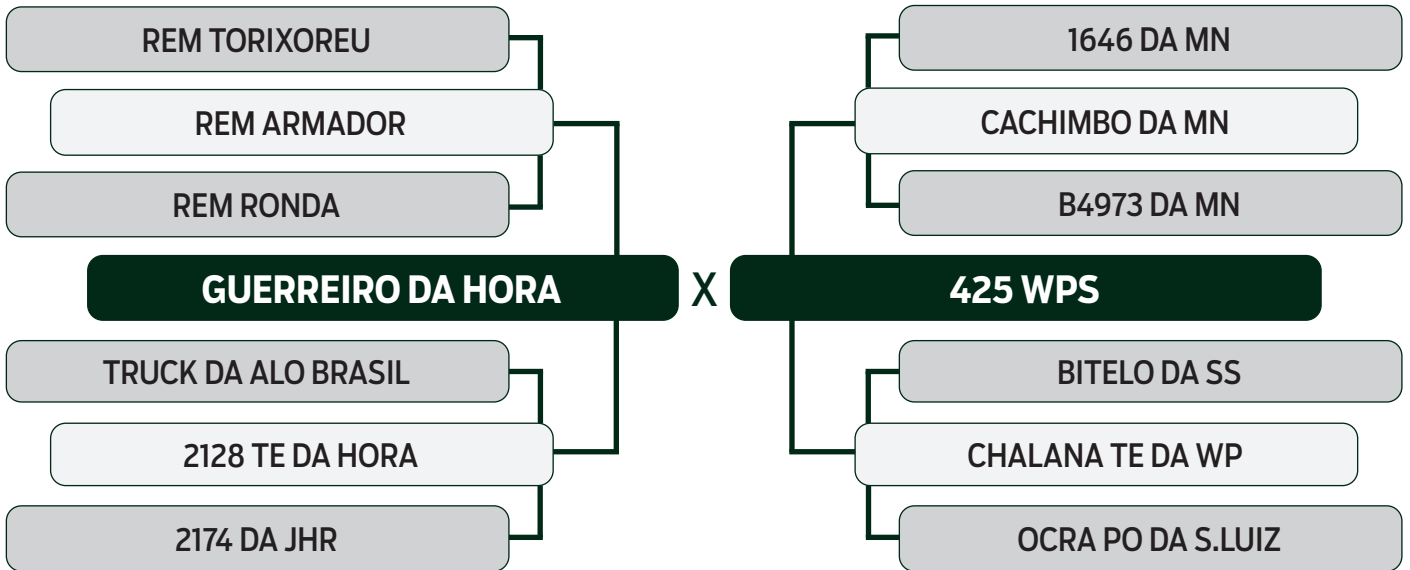

	iABCZ	PD-ED	PS-ED	PM-EM	TMD	IPP	STAY	PE-365	AOL	ACAB	MAR	M
DECA	13.32	6.44	11.75	2.02	6.03	-11.11	34.84	0.860	3.133	0.682	1.36	2.853
INDICE	1	1	1	2	1	2	2	1	1	3	1	1



FAZENDA SANTA FÉ

51

2680 FIV WP

SEXO: MACHO - REG: NWP 2680 - RAÇA: NELORE PO - NASC.: 08/08/2022
 PESO: 542 KG - PE: 33 CM

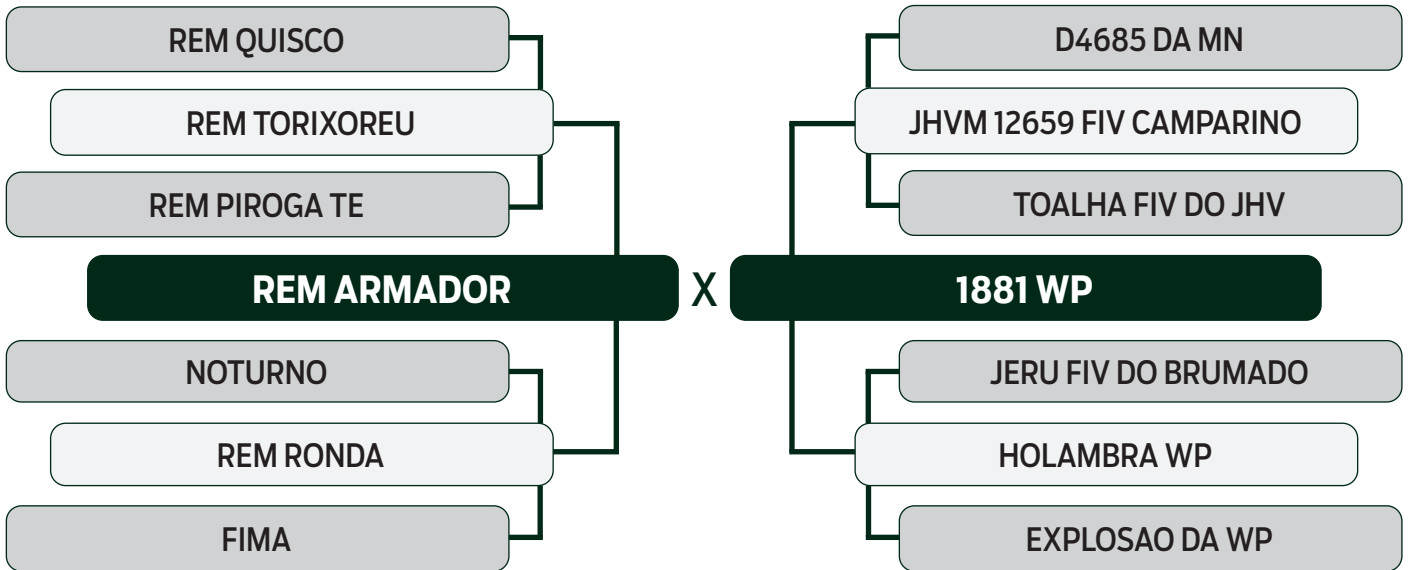

	iABCZ	PD-ED	PS-ED	PM-EM	TMD	IPP	STAY	PE-365	AOL	ACAB	MAR	M
DECA	18.60	7.84	16.76	2.85	7.52	-14.16	37.64	0.899	2.673	1.827	-0.32	3.620
INDICE	1	1	1	1	1	2	1	1	1	1	7	1



FAZENDA SANTA FÉ

52

2741 WP

SEXO: MACHO - REG: NWP 2741 - RAÇA: NELORE PO - NASC.: 24/09/2022
 PESO: 556 KG - PE: 36 CM

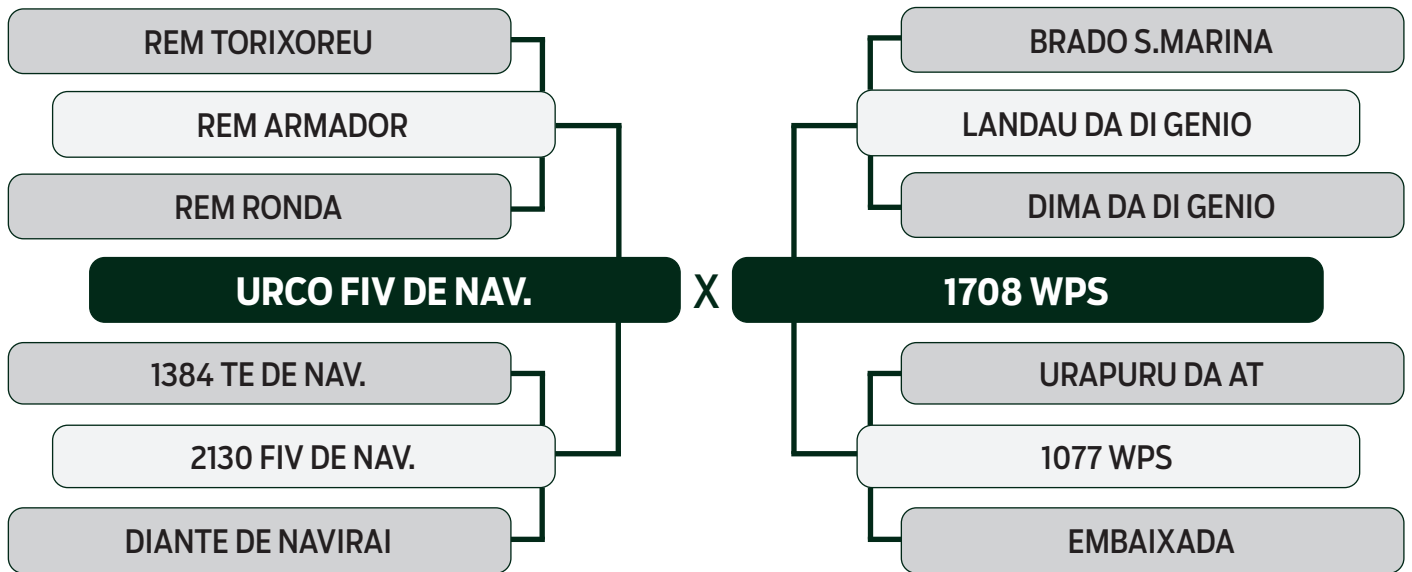

	iABCZ	PD-ED	PS-ED	PM-EM	TMD	IPP	STAY	PE-365	AOL	ACAB	MAR	M
DECA	11.37	5.73	14.32	3.13	7.08	-9.51	29.42	0.896	0.908	-0.880	0.91	2.995
INDICE	2	2	1	1	1	3	7	1	3	9	2	1



FAZENDA SANTA FÉ

53

2635 WP

SEXO: MACHO - REG: NWP 2635 - RAÇA: NELORE PO - NASC.: 16/07/2022
 PESO: 550 KG - PE: 40 CM

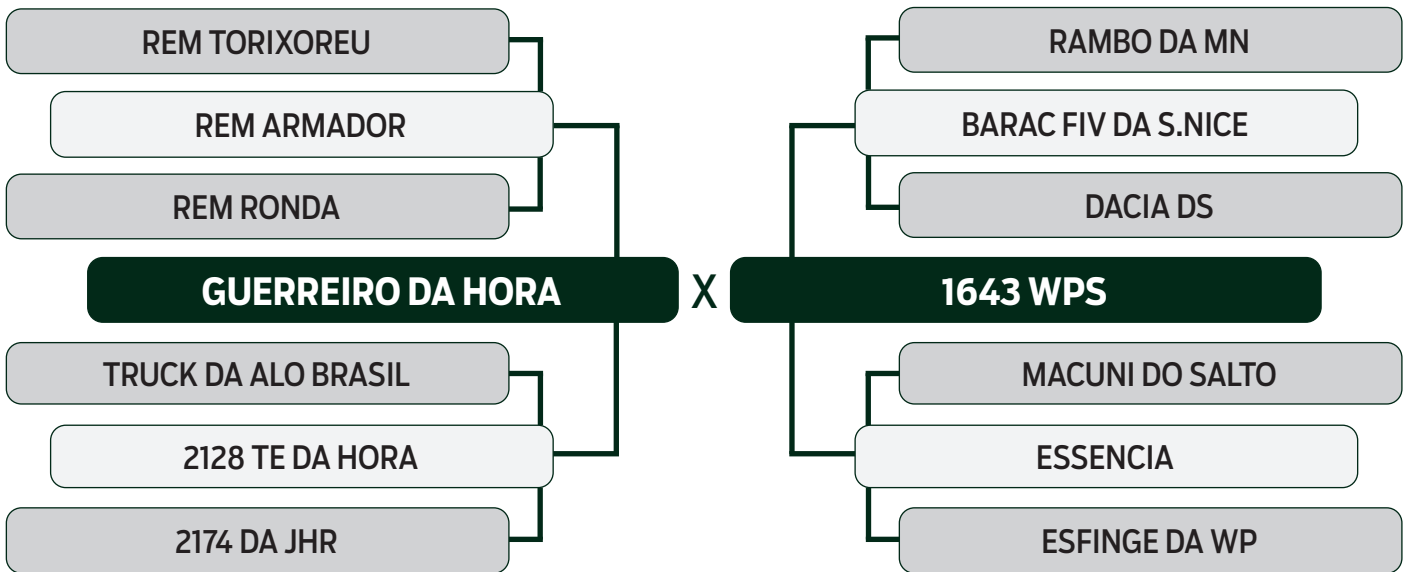

	iABCZ	PD-ED	PS-ED	PM-EM	TMD	IPP	STAY	PE-365	AOL	ACAB	MAR	M
DECA	16.59	5.34	12.41	3.25	6.52	-21.89	35.80	1.015	2.361	0.494	1.49	3.598
INDICE	1	2	1	1	1	1	1	1	1	3	1	1



FAZENDA SANTA FÉ

54

2708 WP

SEXO: MACHO - REG: NWP 2708 - RAÇA: NELORE PO - NASC.: 11/09/2022
 PESO: 518 KG - PE: 33 CM

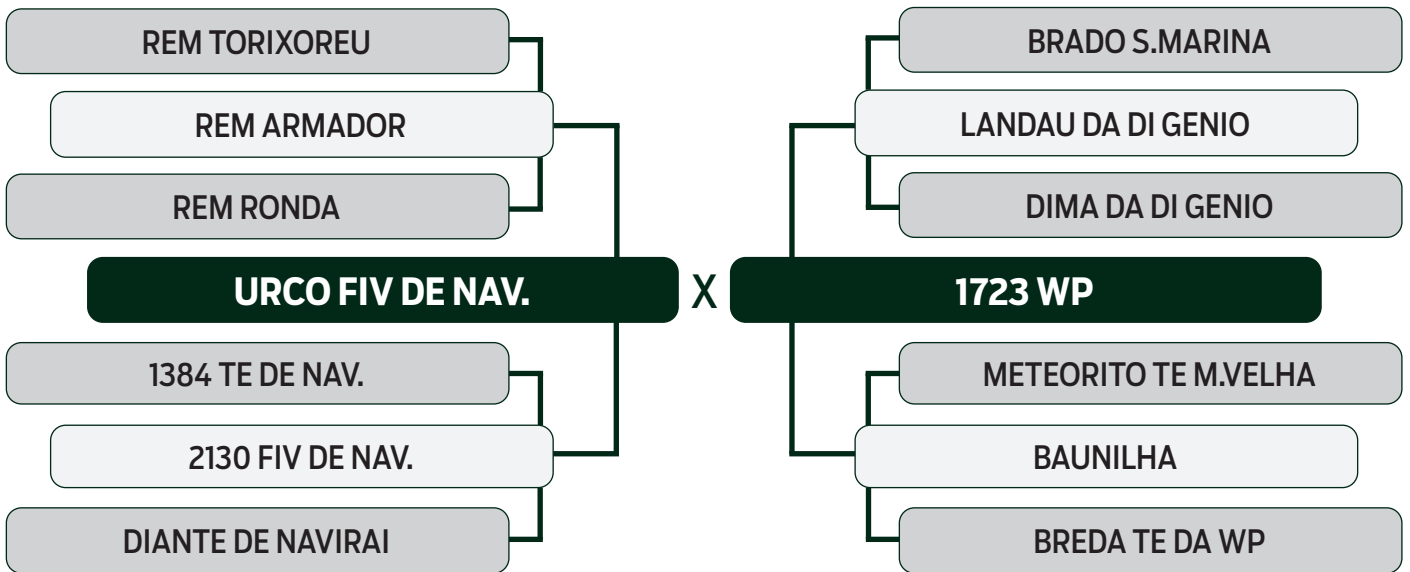

	iABCZ	PD-ED	PS-ED	PM-EM	TMD	IPP	STAY	PE-365	AOL	ACAB	MAR	M
DECA	12.55	7.58	15.22	3.24	7.89	-8.27	29.84	0.832	0.908	-0.710	1.00	2.290
INDICE	1	1	1	1	1	3	6	1	3	8	2	2



FAZENDA SANTA FÉ

55

2711 FIV WP

SEXO: MACHO - REG: NWP 2711 - RAÇA: NELORE PO - NASC.: 11/09/2022
 PESO: 552 KG - PE: 38 CM

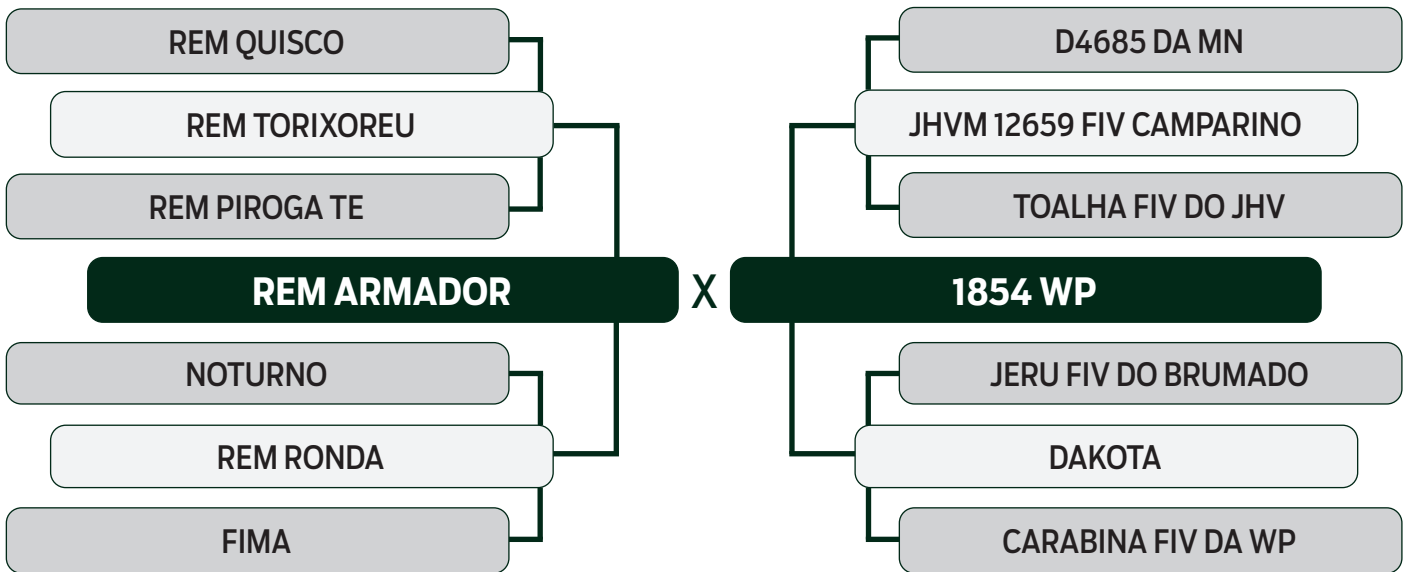

	iABCZ	PD-ED	PS-ED	PM-EM	TMD	IPP	STAY	PE-365	AOL	ACAB	MAR	M
DECA	18.95	7.40	16.18	3.36	7.96	-14.57	38.24	0.903	2.537	1.765	-0.47	4.069
INDICE	1	1	1	1	1	2	1	1	1	1	7	1



FAZENDA SANTA FÉ

56

2728 WP

SEXO: MACHO - REG: NWP 2728 - RAÇA: NELORE PO - NASC.: 16/09/2022
 PESO: 524 KG - PE: 36 CM

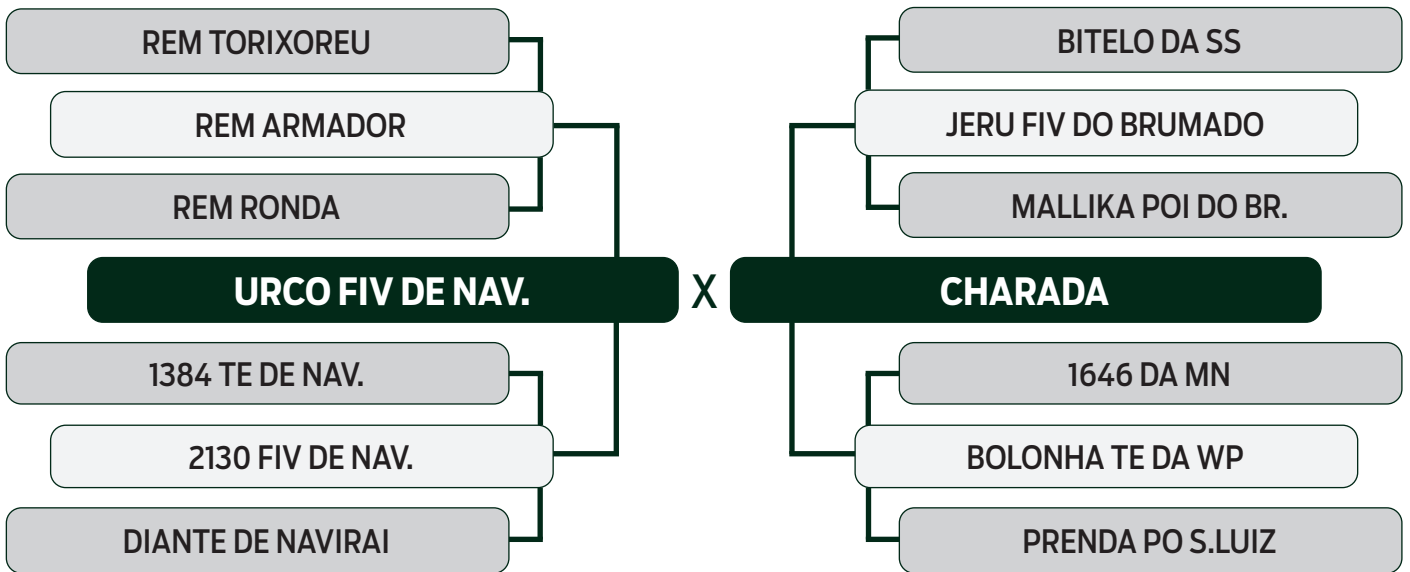

	iABCZ	PD-ED	PS-ED	PM-EM	TMD	IPP	STAY	PE-365	AOL	ACAB	MAR	M
DECA INDICE	12.07	7.99	16.46	3.43	8.24	0.25	29.93	0.783	0.765	-0.727	0.51	2.170
	1	1	1	1	1	6	6	1	4	8	3	2



FAZENDA SANTA FÉ

58

2733 WP

SEXO: MACHO - REG: NWP 2733 - RAÇA: NELORE PO - NASC.: 16/09/2022
 PESO: 510 KG - PE: 34 CM

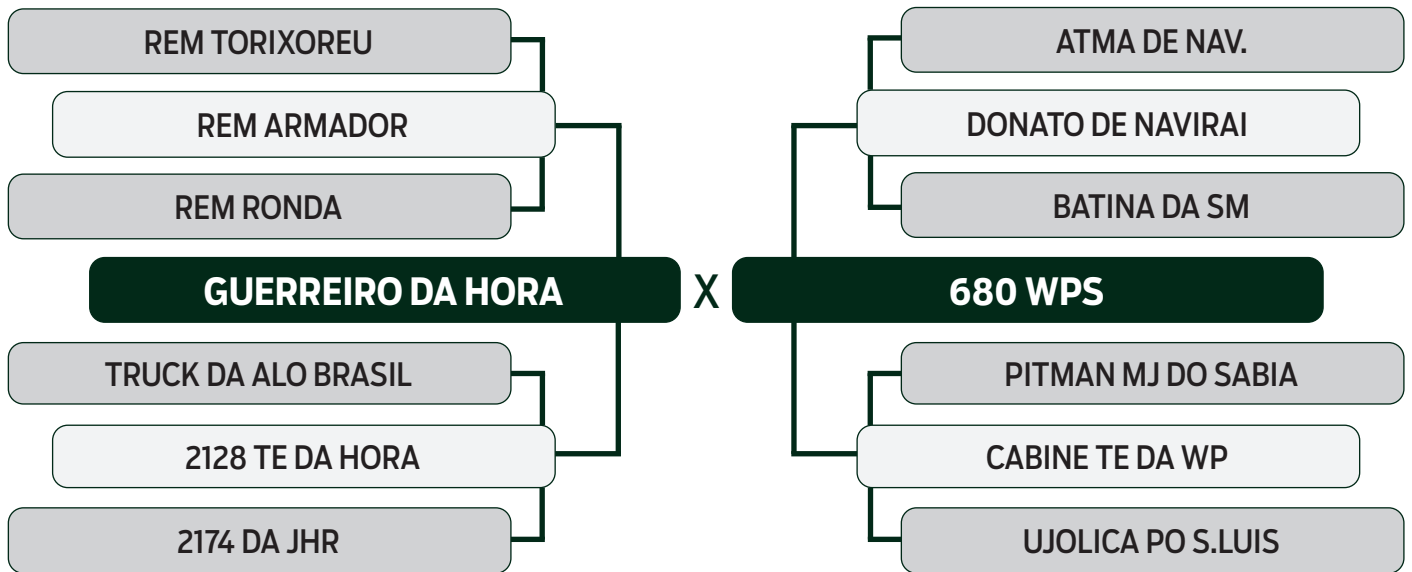

	iABCZ	PD-ED	PS-ED	PM-EM	TMD	IPP	STAY	PE-365	AOL	ACAB	MAR	M
DECA	11.97	6.96	12.66	1.14	4.94	-11.24	32.53	0.694	2.757	-0.288	1.40	2.610
INDICE	1	1	1	3	2	2	3	1	1	7	1	1



FAZENDA SANTA FÉ

59

2658 WP

SEXO: MACHO - REG: NWP 2658 - RAÇA: NELORE PO - NASC.: 02/08/2022
 PESO: 522 KG - PE: 38 CM

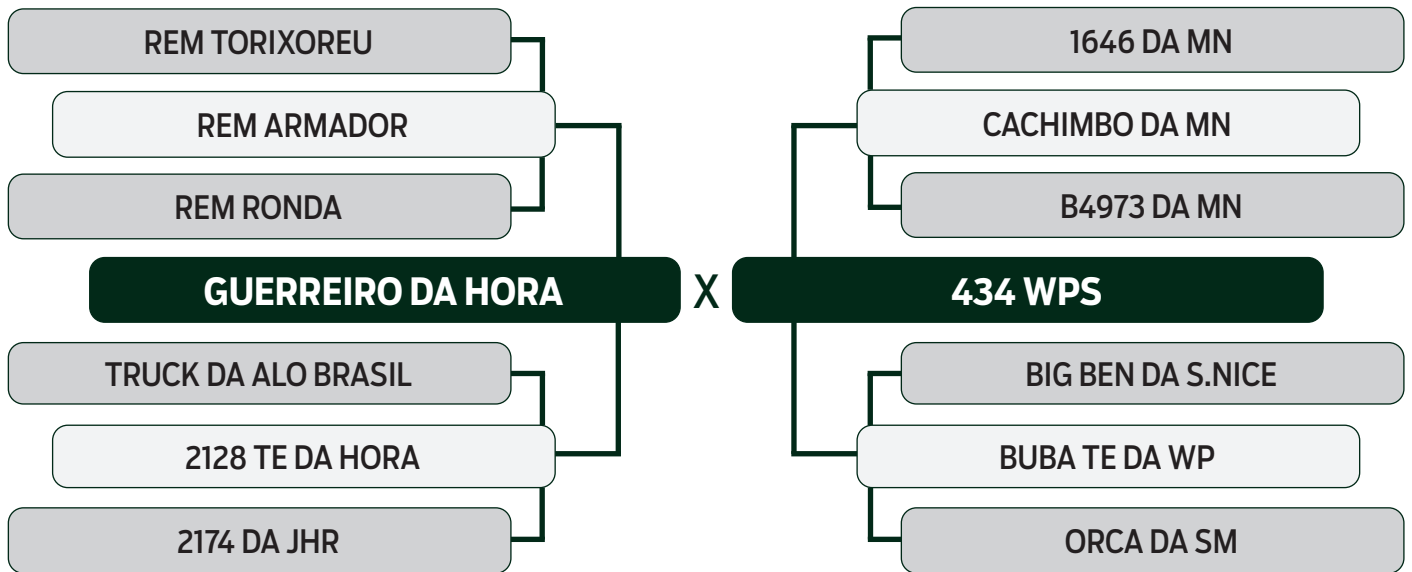

	iABCZ	PD-ED	PS-ED	PM-EM	TMD	IPP	STAY	PE-365	AOL	ACAB	MAR	M
DECA	14.89	7.21	11.57	1.68	5.82	-15.01	35.57	0.802	3.464	0.841	1.61	2.808
INDICE	1	1	2	2	1	2	1	1	1	2	1	1



LEILÃO
SUPER
NELORE
 VIRTUAL
 6ª EDIÇÃO

NELORE ABRA

60

468 DO ABRA

SEXO: MACHO - REG: ABRA 468 - RAÇA: NELORE PO - NASC.: 23/07/2022
 PESO: 584 KG - PE: 37 CM

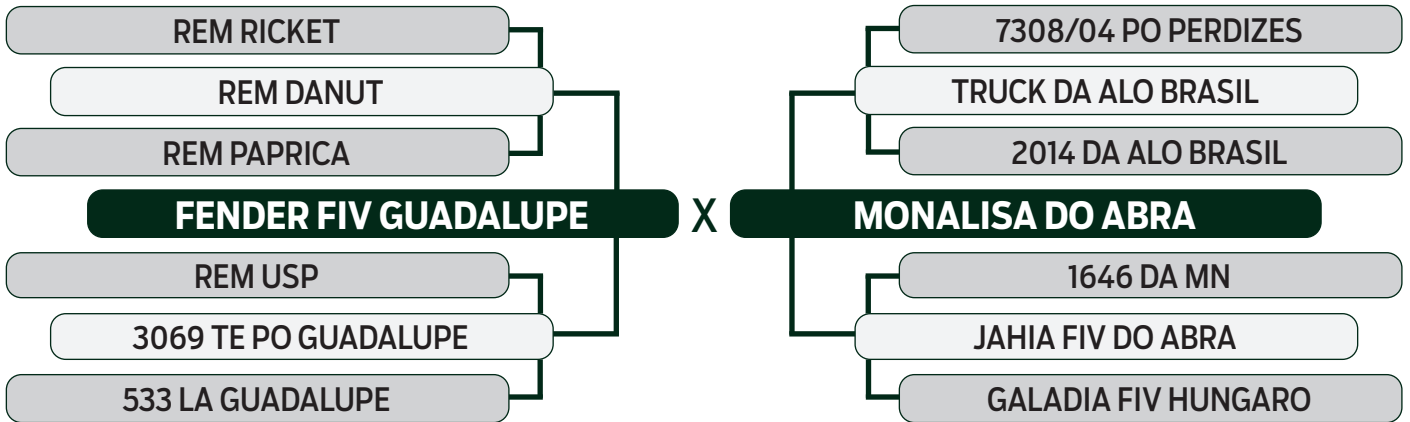

	iABCZ	PD-ED	PS-ED	PM-EM	TMD	IPP	STAY	PE-365	AOL	ACAB	MAR	M
DECA ÍNDICE	15.36	8.87	16.10	2.27	7.08	-6.54	35.50	0.530	4.470	-0.190	1.15	3.740
	1	1	1	1	1	4	1	2	1	6	1	1



	IQG	PD	TMD	PS	GPD	IPP	PES	AOL	EGS
TOP ÍNDICE	22.090	8.870	7.080	16.100	7.230	-6.530	1.090	4.470	-0.190
	7%	4%	5%	6%	11%	40%	8%	0.1%	58%



Avaliação por Ultrassonografia										
AOL (cm ²)			ACABAMENTO (mm)			MARMOREIO (%)			ÍNDICE	RANK
OBS	GRUPO	CLASSE	OBS	GRUPO	CLASSE	OBS	GRUPO	CLASSE		
77.91	Superior	105	2.96	Inferior	73				95.37	20



NELORE ABRA

61

473 DO ABRA

SEXO: MACHO - REG: ABRA 473 - RAÇA: NELORE PO - NASC.: 25/07/2022
 PESO: 553 KG - PE: 38 CM

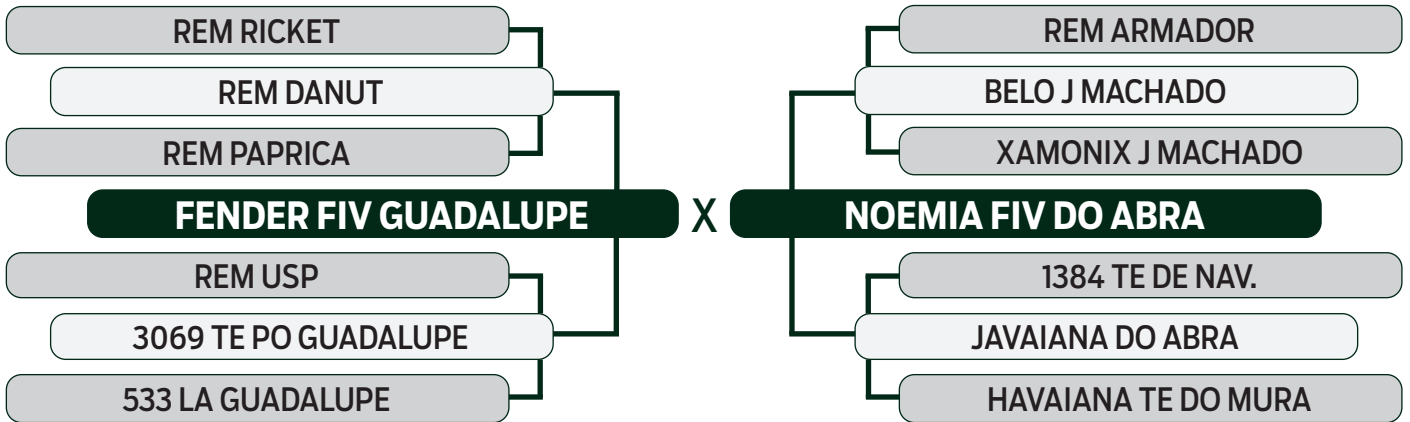

	iABCZ	PD-ED	PS-ED	PM-EM	TMD	IPP	STAY	PE-365	AOL	ACAB	MAR	M
DECA. ÍNDICE	23.81	9.28	17.33	1.81	6.69	-26.80	41.57	1.450	2.290	3.180	1.10	4.950
	1	1	1	2	1	1	1	1	1	1	1	1



	IQG	PD	TMD	PS	GPD	IPP	PES	AOL	EGS
TOP. ÍNDICE	33.340	9.280	6.690	17.330	8.050	-26.800	2.280	2.290	3.180
	1%	4%	7%	4%	8%	2%	0.1%	7%	0.5%



Avaliação por Ultrassonografia										
AOL (cm ²)			ACABAMENTO (mm)			MARMOREIO (%)			ÍNDICE	RANK
OBS	GRUPO	CLASSE	OBS	GRUPO	CLASSE	OBS	GRUPO	CLASSE		
72.46	Regular	97	3.98	Regular	98				94.81	22



NELORE ABRA

62

487 DO ABRA

SEXO: MACHO - REG: ABRA 487 - RAÇA: NELORE PO - NASC.: 01/09/2022
 PESO: 556 KG - PE: 34 CM

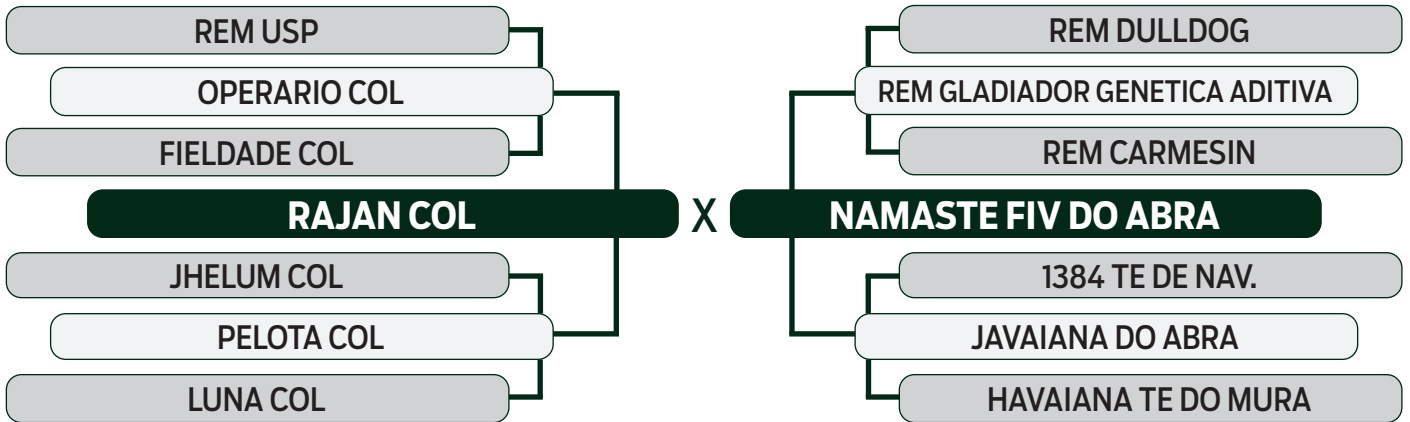

	iABCZ	PD-ED	PS-ED	PM-EM	TMD	IPP	STAY	PE-365	AOL	ACAB	MAR	M
DECA. INDICE	19.41	6.99	15.41	4.73	10.23	-19.92	36.41	0.810	1.800	1.790	0.77	3.160
	1	1	1	1	1	1	1	1	1	1	2	1



	IQG	PD	TMD	PS	GPD	IPP	PES	AOL	EGS
TOP. INDICE	27.650	6.990	10.230	15.410	8.420	-19.920	1.330	1.800	1.790
	3%	11%	0.5%	7%	7%	6%	4%	14%	6%



Avaliação por Ultrassonografia										
AOL (cm ²)			ACABAMENTO (mm)			MARMOREIO (%)			ÍNDICE	RANK
OBS	GRUPO	CLASSE	OBS	GRUPO	CLASSE	OBS	GRUPO	CLASSE		
63.03	Regular	90	4.34	Superior	107				95.94	18



NELORE ABRA

63

501 FIV DO ABRA

SEXO: MACHO - REG: ABRA 501 - RAÇA: NELORE PO - NASC.: 12/09/2022
 PESO: 566 KG - PE: 44 CM

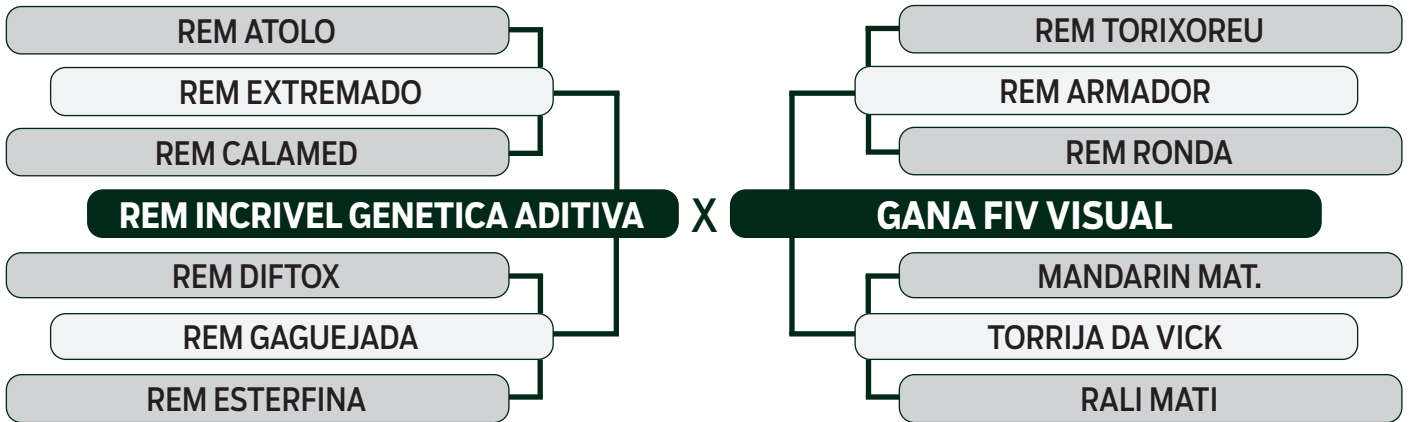

	iABCZ	PD-ED	PS-ED	PM-EM	TMD	IPP	STAY	PE-365	AOL	ACAB	MAR	M
DECA. INDICE	25.69	9.22	20.06	3.01	9.11	-16.72	43.14	1.800	1.820	1.850	-0.95	5.180
	1	1	1	1	1	1	1	1	1	1	9	1



	IQG	PD	TMD	PS	GPD	IPP	PES	AOL	EGS
TOP. INDICE	36.930	9.220	9.110	20.060	10.840	-16.720	2.570	1.820	1.850
	0.5%	4%	2%	2%	2%	11%	0.1%	14%	5%



Avaliação por Ultrassonografia										
AOL (cm ²)			ACABAMENTO (mm)			MARMOREIO (%)			ÍNDICE	RANK
OBS	GRUPO	CLASSE	OBS	GRUPO	CLASSE	OBS	GRUPO	CLASSE		
70.42	Superior	102	4.96	Elite	123				110.59	2

