

CATÁLOGO

1º LEILÃO
NELORE
GRUPO
COSTA

GENÉTICA CERTIFICADA



100% GENOTIPADOS

GRUPOCOSTA
GENÉTICA NELORE CERTIFICADA

SAVE THE DATE

06 JUNHO | 20H

ASSESSORIAS:



TRANSMISSÃO:



AVALIAÇÕES:



LEILOEIRA:



PARCEIROS:



GRUPOCOSTA
GENÉTICA NELORE CERTIFICADA

1º LEILÃO
NELORE
GRUPO
COSTA

GENÉTICA CERTIFICADA

MACHOS



GRUPOCOSTA
GENÉTICA NELORE CERTIFICADA

LOTE
1000

RGN: GCGC310 | NASC.: 12/09/2020 | PESO: 747KG | CE: 36 | GENOTIPADO: G

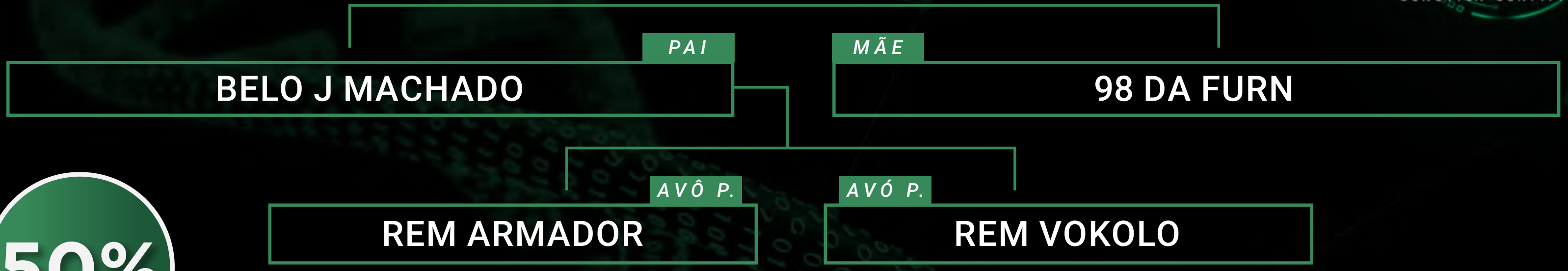

ALASSIO TE DA FURN



50%



Clique no play para ver o vídeo

ANCP

MGTE:	TOP:	MP120:	DP210:	DP450:	DPE365:	DSTAY:	D3P:	DAOL:	DACAB:
33,04	0,1	4,64	18,66	34,5	1,48	92,93	69,94	5,9	0,43

PMGZ

iABCZ:	DECA:	PD-ED:	PS-ED:	PM-EM:	IPP:	STAY:	PE-450:	AOL:	ACAB:
25,4	1	10,77	21,68	3,62	-17,62	39,35	1,779	3,805	2,362

- PRECOCIDADE
- PESO
- PE
- AOL
- ACAB



LOTE

1

RGN: GCGC234 | NASC.: 16/09/2019 | PESO: 885KG | CE: 43 | GENOTIPADO: G



ANZIO DA FURN

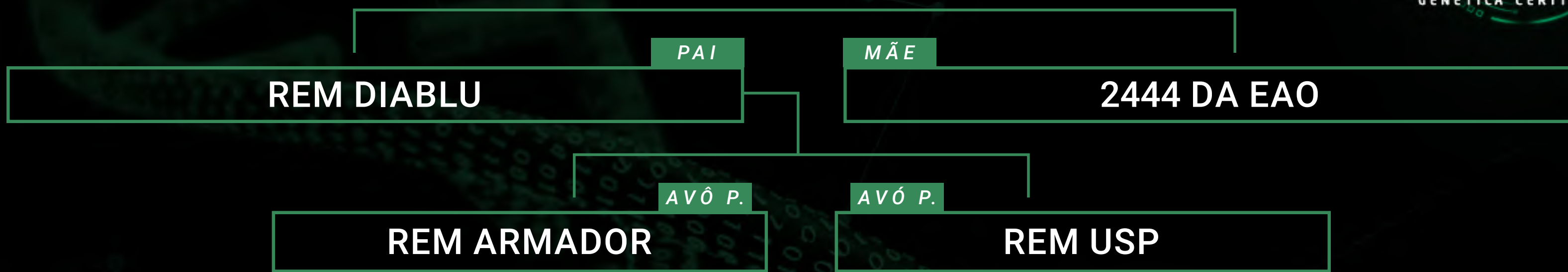

Clique no play para ver o vídeo



ANCP

MGTE:	TOP:	MP120:	DP210:	DP450:	DPE365:	DSTAY:	D3P:	DAOL:	DACAB:
32,25	0,1	5,07	15,64	32,17	1,56	89,5	82,34	4,05	0,08

PMGZ

iABCZ:	DECA:	PD-ED:	PS-ED:	PM-EM:	IPP:	STAY:	PE-450:	AOL:	ACAB:
23,45	1	7,90	20,42	4,10	-22,53	37,32	1,662	2,574	-0,171

PESO

PE

ACAB



LOTE

2

RGN: GCGC217 | NASC.: 07/08/2019 | PESO: 825KG | CE: 41 | GENOTIPADO: G



ASTI TE DA FURN

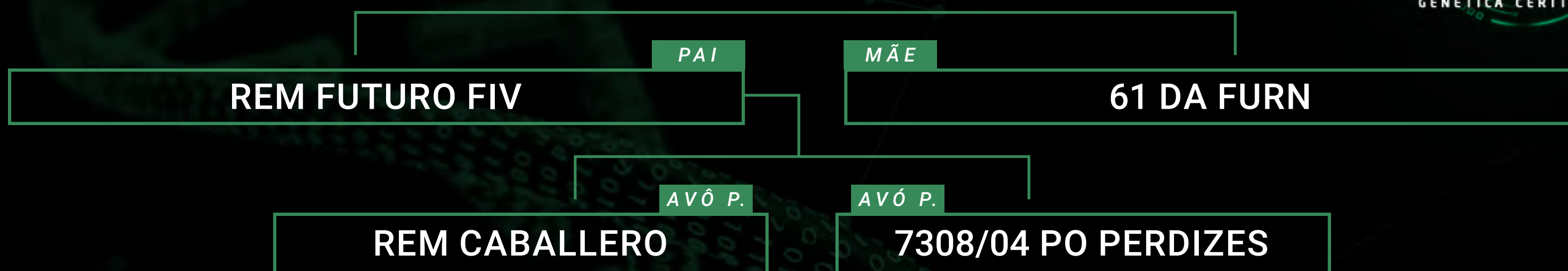

Clique no play para ver o vídeo

ANCP

MGTE:	TOP:	MP120:	DP210:	DP450:	DPE365:	DSTAY:	D3P:	DAOL:	DACAB:
30,18	0,5	2,15	18,54	28,73	1,66	89,42	68,21	5,73	0,68

PMGZ

iABCZ:	DECA:	PD-ED:	PS-ED:	PM-EM:	IPP:	STAY:	PE-450:	AOL:	ACAB:
23,74	1	13,90	26,15	1,73	-20,82	32,43	1,671	4,939	1,562

PRECOCIDADE

PESO

PE

AOL



LOTE

3

RGN: GCGC319 | NASC.: 21/09/2020 | PESO: 735KG | CE: 36 | GENOTIPADO: G



ALVIANO TE DA FURN

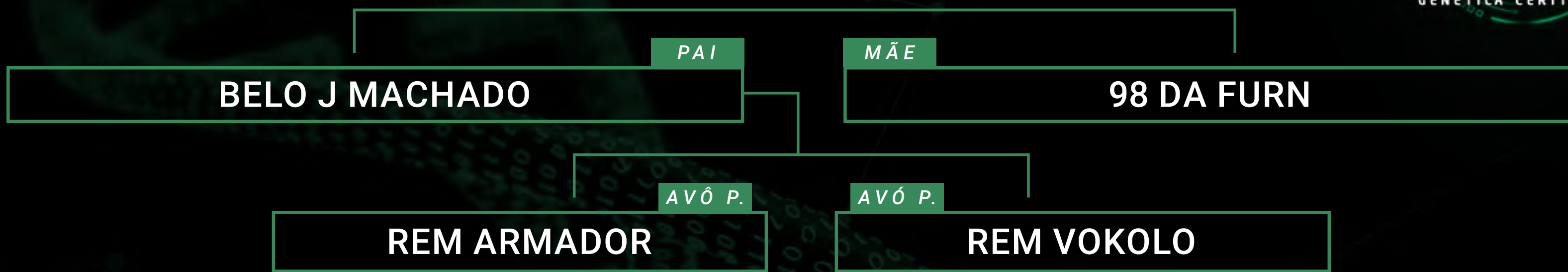

Clique no play para ver o vídeo



ANCP

MGTE:	TOP:	MP120:	DP210:	DP450:	DPE365:	DSTAY:	D3P:	DAOL:	DACAB:
30,57	0,5	5,15	16,53	29,79	1,16	92,8	78,6	3,29	0,32

PMGZ

iABCZ:	DECA:	PD-ED:	PS-ED:	PM-EM:	IPP:	STAY:	PE-450:	AOL:	ACAB:
25,4	1	10,77	21,68	3,62	-17,62	39,35	1,779	3,805	2,362

PRECOCIDADE

PESO



LOTE

4

RGN: GCGC314 | NASC.: 15/09/2020 | PESO: 723KG | CE: 39 | GENOTIPADO: G



314 TE DA FURN

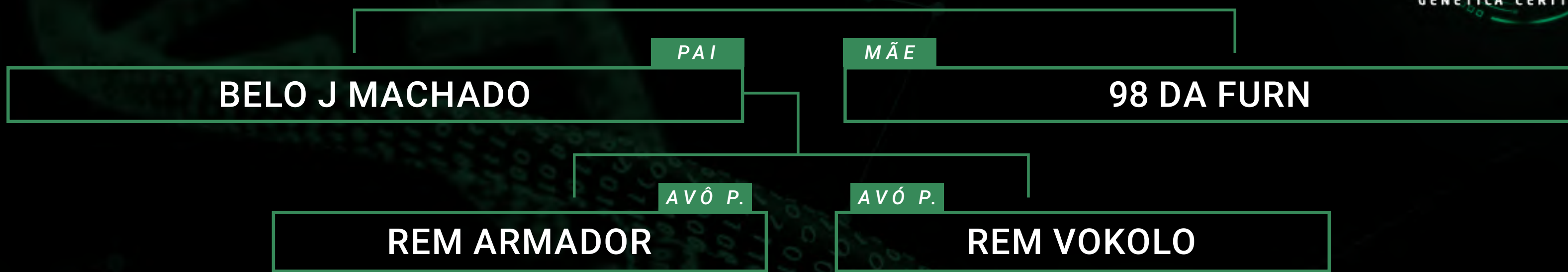

Clique no play para ver o vídeo

ANCP

MGTE:	TOP:	MP120:	DP210:	DP450:	DPE365:	DSTAY:	D3P:	DAOL:	DACAB:
30,66	0,5	5,92	15,04	32,43	1,45	90,55	74,68	2,91	0,01

PMGZ

iABCZ:	DECA:	PD-ED:	PS-ED:	PM-EM:	IPP:	STAY:	PE-450:	AOL:	ACAB:
25,4	1	10,77	21,68	3,62	-17,62	39,35	1,779	3,805	2,362

PRECOCIDADE

PESO

PE



LOTE

5

RGN: GCGC312 | NASC.: 12/09/2020 | PESO: 731KG | CE: 37 | GENOTIPADO: G



312 TE DA FURN

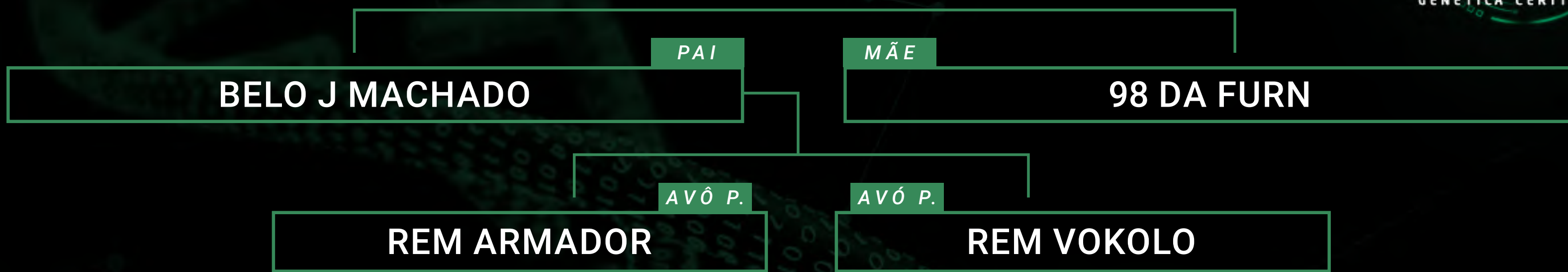

Clique no play para ver o vídeo

ANCP

MGTE:	TOP:	MP120:	DP210:	DP450:	DPE365:	DSTAY:	D3P:	DAOL:	DACAB:
31,57	0,5	2,63	19,16	36,08	1,06	88,2	77,95	3,05	0,31

PMGZ

iABCZ:	DECA:	PD-ED:	PS-ED:	PM-EM:	IPP:	STAY:	PE-450:	AOL:	ACAB:
25,4	1	10,77	21,68	3,62	-17,62	39,35	1,779	3,805	2,362

PRECOCIDADE

PESO

PE

AOL



LOTE

6

RGN: GCGC324 | NASC.: 29/10/2020 | PESO: 709KG | CE: 40 | GENOTIPADO: G



324 TE DA FURN

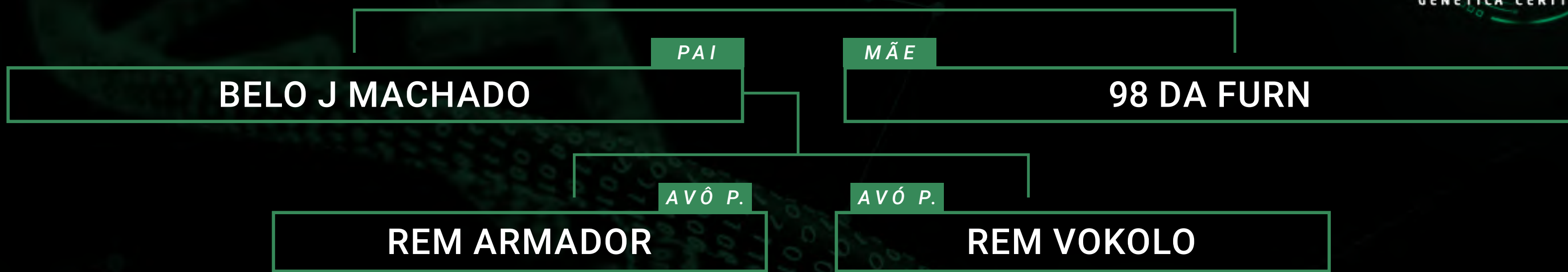

Clique no play para ver o vídeo

ANCP

MGTE:	TOP:	MP120:	DP210:	DP450:	DPE365:	DSTAY:	D3P:	DAOL:	DACAB:
37,38	0,1	6,36	22,05	41,4	1,34	94,23	70,78	6,17	-0,19

PMGZ

iABCZ:	DECA:	PD-ED:	PS-ED:	PM-EM:	IPP:	STAY:	PE-450:	AOL:	ACAB:
25,4	1	10,77	21,68	3,62	-17,62	39,35	1,779	3,805	2,362

PRECOCIDADE

PESO

PE

AOL



LOTE

7

RGN: GCGC309 | NASC.: 11/09/2020 | PESO: 690KG | CE36,5 | GENOTIPADO: G



ARPINO TE GRUPO COSTA

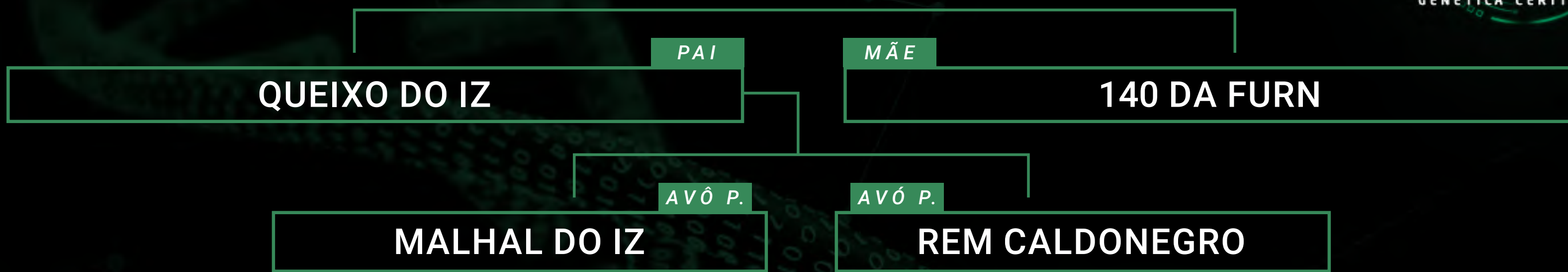

Clique no play para ver o vídeo

ANCP

MGTE:	TOP:	MP120:	DP210:	DP450:	DPE365:	DSTAY:	D3P:	DAOL:	DACAB:
18,52	11	2,06	14,06	23,37	0,83	64,61	65,53	1,85	0,55

PMGZ

iABCZ:	DECA:	PD-ED:	PS-ED:	PM-EM:	IPP:	STAY:	PE-450:	AOL:	ACAB:
20,84	1	9,41	23,63	3,43	-13,89	34,26	0,980	2,267	2,321

PRECOCIDADE

PESO



LOTE

8

RGN: GCGC326 | NASC.: 06/11/2020 | PESO: 580KG | CE: 36 | GENOTIPADO: G



326 DA FURN

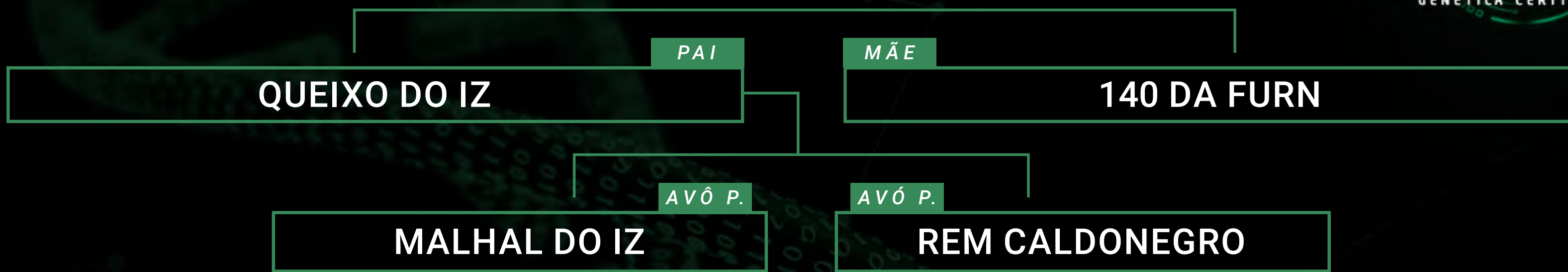

Clique no play para ver o vídeo

ANCP

MGTE:	TOP:	MP120:	DP210:	DP450:	DPE365:	DSTAY:	D3P:	DAOL:	DACAB:
22,97	4	0,71	16,96	28,34	0,99	72,04	69,77	2	0,32

PMGZ

iABCZ:	DECA:	PD-ED:	PS-ED:	PM-EM:	IPP:	STAY:	PE-450:	AOL:	ACAB:
20,84	1	9,41	23,63	3,43	-13,89	34,26	0,980	2,267	2,321

PRECOCIDADE

ACAB



LOTE

9

RGN: GCGC306 | NASC.: 31/07/2020 | PESO: 727KG | CE: 37 | GENOTIPADO: G



306 TE DA FURN

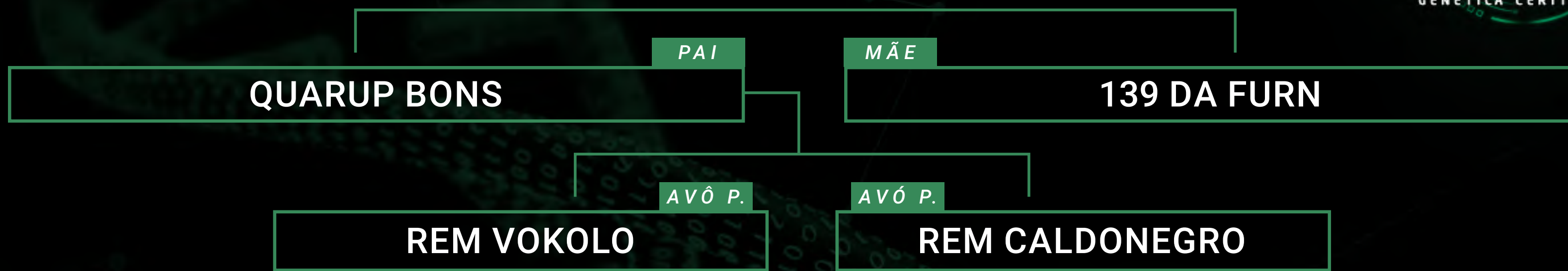

Clique no play para ver o vídeo



ANCP

MGTE:	TOP:	MP120:	DP210:	DP450:	DPE365:	DSTAY:	D3P:	DAOL:	DACAB:
29,06	0,5	3,84	16,54	27,52	2	91,37	81,28	1,01	0,35

PMGZ

iABCZ:	DECA:	PD-ED:	PS-ED:	PM-EM:	IPP:	STAY:	PE-450:	AOL:	ACAB:
28,92	1	10,12	23,29	4,67	-31,77	38,88	1,872	2,751	1,706

PRECOCIDADE



LOTE

10

RGN: GCGC304 | NASC.: 30/07/2020 | PESO: 690KG | CE: 42 | GENOTIPADO: G



304 TE DA FURN

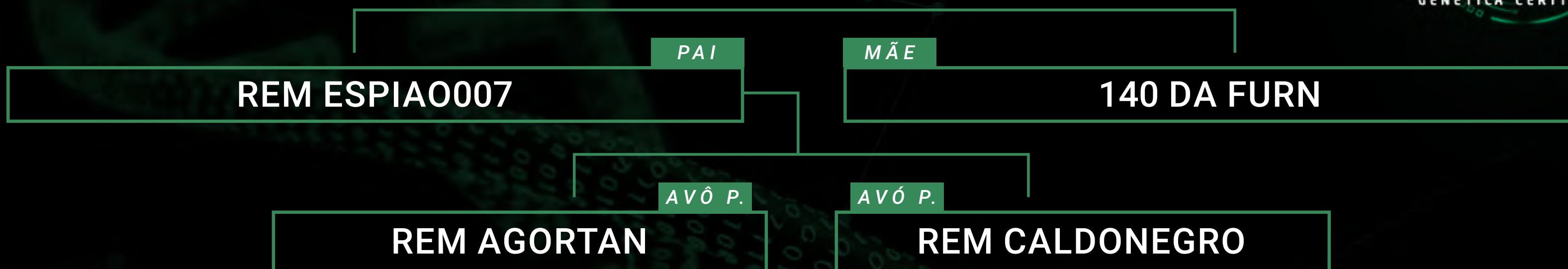

Clique no play para ver o vídeo

ANCP

MGTE:	TOP:	MP120:	DP210:	DP450:	DPE365:	DSTAY:	D3P:	DAOL:	DACAB:
21,22	6	2,33	10,14	16,01	1,25	84,02	77,79	1,7	0,29

PMGZ

iABCZ:	DECA:	PD-ED:	PS-ED:	PM-EM:	IPP:	STAY:	PE-450:	AOL:	ACAB:
29,66	1	13,11	25,47	3,96	-24,43	38,53	2,352	2,517	4,746

PRECOCIDADE

PE

AOL

ACAB



LOTE
11

RGN: GCGC331 | NASC.: 04/12/2020 | PESO: 500KG | CE: 32 | GENOTIPADO: G



331 DA FURN

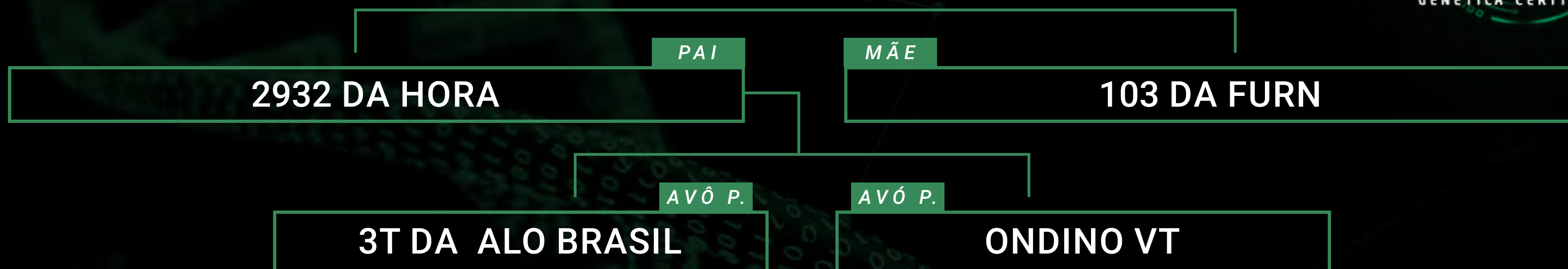

Clique no play para ver o vídeo



ANCP

MGTE:	TOP:	MP120:	DP210:	DP450:	DPE365:	DSTAY:	D3P:	DAOL:	DACAB:
17,15	13	1,9	7,06	14,55	1,17	76,21	75,05	0,58	0,24

PMGZ

iABCZ:	DECA:	PD-ED:	PS-ED:	PM-EM:	IPP:	STAY:	PE-450:	AOL:	ACAB:
14,89	1	5,81	10,58	3,74	-13,16	34,48	0,872	1,069	0,315

LOTE
12

RGN: GCGC291 | NASC.: 19/01/2020 | PESO: 651KG | CE36,5 | GENOTIPADO: G



291 DA FURN

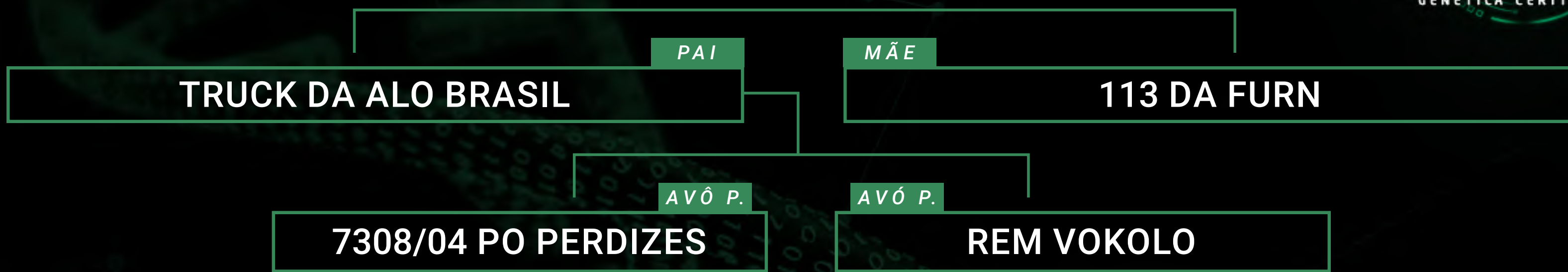

Clique no play para ver o vídeo



ANCP

MGTE:	TOP:	MP120:	DP210:	DP450:	DPE365:	DSTAY:	D3P:	DAOL:	DACAB:
29,69	0,5	5,83	11,22	26,49	1,82	89,82	80,09	4,52	0,65

PMGZ

iABCZ:	DECA:	PD-ED:	PS-ED:	PM-EM:	IPP:	STAY:	PE-450:	AOL:	ACAB:
25,93	1	9,19	21,82	4,27	-21,96	39,20	2,131	4,398	1,069

PRECOCIDADE

PE

AOL

ACAB



LOTE
13

RGN: GCGC321 | NASC.: 05/10/2020 | PESO: 621KG | CE: 38 | GENOTIPADO: G



ARCORE DA FURN

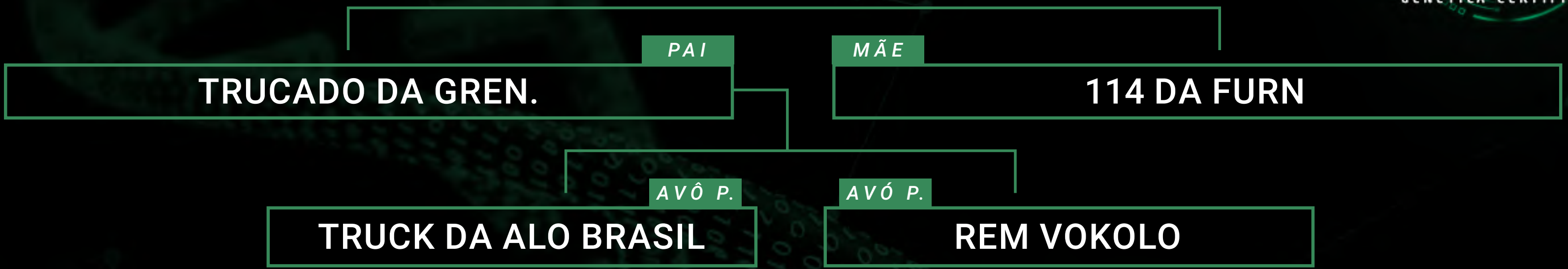

Clique no play para ver o vídeo

ANCP

MGTE:	TOP:	MP120:	DP210:	DP450:	DPE365:	DSTAY:	D3P:	DAOL:	DACAB:
34,74	0,1	5,63	17,76	34,87	2,23	90,89	87,84	3,37	0,36

PMGZ

iABCZ:	DECA:	PD-ED:	PS-ED:	PM-EM:	IPP:	STAY:	PE-450:	AOL:	ACAB:
24,93	1	9,98	21,90	1,95	-23,10	39,57	2,107	4,404	1,156

PRECOCIDADE

PESO

PE

AOL

ACAB



LOTE
14

RGN: GCGC318 | NASC.: 21/09/2020 | PESO: 685KG | CE: 37 | GENOTIPADO: G



318 TE DA FURN

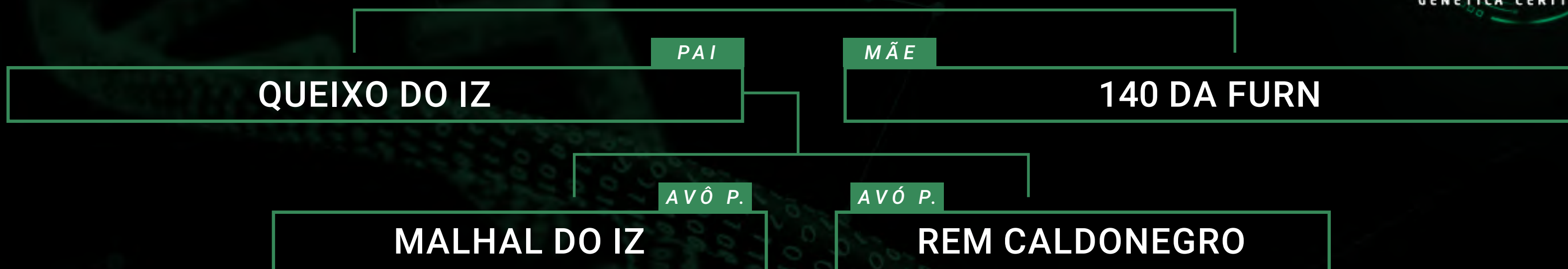

Clique no play para ver o vídeo



ANCP

MGTE:	TOP:	MP120:	DP210:	DP450:	DPE365:	DSTAY:	D3P:	DAOL:	DACAB:
22,1	5	3,04	15,9	30,8	1,06	67,75	58,37	2,96	0,87

PMGZ

iABCZ:	DECA:	PD-ED:	PS-ED:	PM-EM:	IPP:	STAY:	PE-450:	AOL:	ACAB:
20,84	1	9,41	23,63	3,43	-13,89	34,26	0,980	2,267	2,321

PRECOCIDADE

AOL

ACAB



LOTE
15

RGN: GCGC323 | NASC.: 05/10/2020 | PESO: 610KG | CE36,5 | GENOTIPADO: G



323 DA FURN

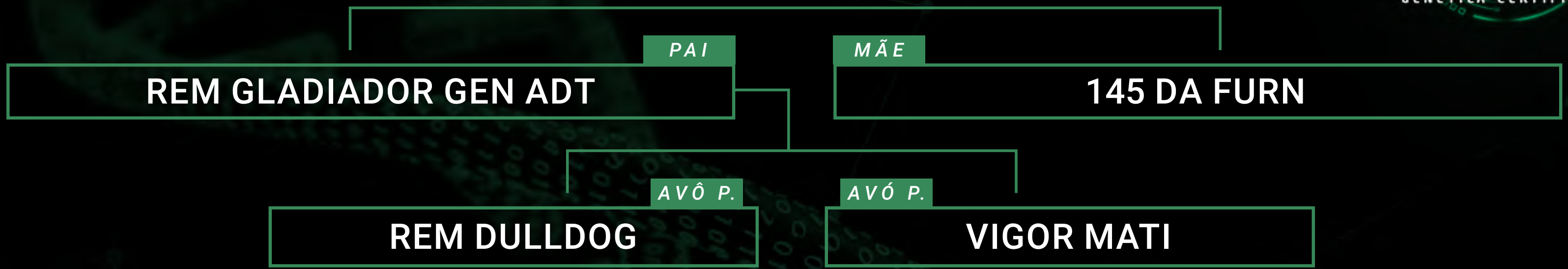

Clique no play para ver o vídeo



ANCP

MGTE:	TOP:	MP120:	DP210:	DP450:	DPE365:	DSTAY:	D3P:	DAOL:	DACAB:
24,34	3	4,05	13,66	25,18	1,55	79,33	77,32	-0,15	0,09

PMGZ

iABCZ:	DECA:	PD-ED:	PS-ED:	PM-EM:	IPP:	STAY:	PE-450:	AOL:	ACAB:
19,49	1	8,40	18,44	3,03	-17,77	34,70	0,914	2,053	1,779

PRECOCIDADE

AOL

ACAB



LOTE
16

RGN: GCGC334 | NASC.: 13/12/2020 | PESO: 628KG | CE36,5 | GENOTIPADO: G



334 TE DA FURN

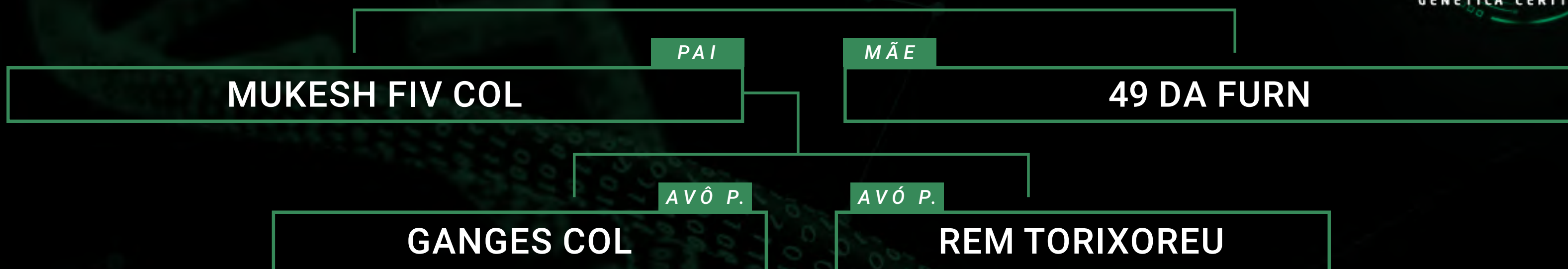

Clique no play para ver o vídeo



ANCP

MGTE:	TOP:	MP120:	DP210:	DP450:	DPE365:	DSTAY:	D3P:	DAOL:	DACAB:
24,77	3	5,82	13,82	26,43	0,66	82,01	66,64	2,48	0,21

PMGZ

iABCZ:	DECA:	PD-ED:	PS-ED:	PM-EM:	IPP:	STAY:	PE-450:	AOL:	ACAB:
16,89	1	9,10	20,82	1,62	-16,73	30,38	1,415	2,951	0,601

PRECOCIDADE

PESO



LOTE
17

RGN: GCGC328 | NASC.: 18/11/2020 | PESO: 595KG | CE: 33 | GENOTIPADO: G



328 DA FURN

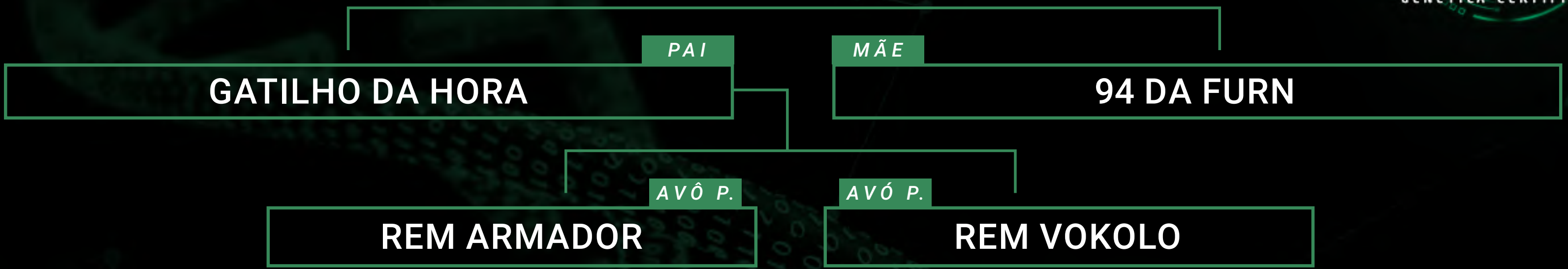

Clique no play para ver o vídeo



ANCP

MGTE:	TOP:	MP120:	DP210:	DP450:	DPE365:	DSTAY:	D3P:	DAOL:	DACAB:
27,08	1	-0,73	17,84	25,76	0,83	91,91	67,92	4,88	-0,18

PMGZ

iABCZ:	DECA:	PD-ED:	PS-ED:	PM-EM:	IPP:	STAY:	PE-450:	AOL:	ACAB:
22,99	1	7,65	18,41	2,09	-26,53	39,72	1,706	4,874	0,644

PRECOCIDADE



LOTE
18

RGN: GCGC302 | NASC.: 29/07/2020 | PESO: 743KG | CE: 39 | GENOTIPADO: G



302 TE DA FURN

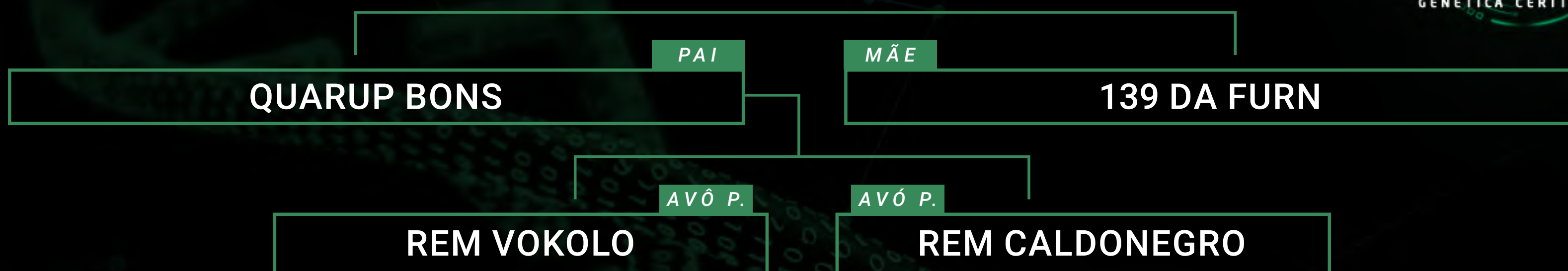

Clique no play para ver o vídeo



ANCP

MGTE:	TOP:	MP120:	DP210:	DP450:	DPE365:	DSTAY:	D3P:	DAOL:	DACAB:
30,33	0,5	5,23	18,35	37,78	1,73	76,04	71,28	4,42	0,46

PMGZ

iABCZ:	DECA:	PD-ED:	PS-ED:	PM-EM:	IPP:	STAY:	PE-450:	AOL:	ACAB:
28,92	1	10,12	23,29	4,67	-31,77	38,88	1,872	2,751	1,706

PRECOCIDADE



LOTE
19

RGN: GCGC322 | NASC.: 05/10/2020 | PESO: 645KG | CE: 37 | GENOTIPADO: G



322 DA FURN

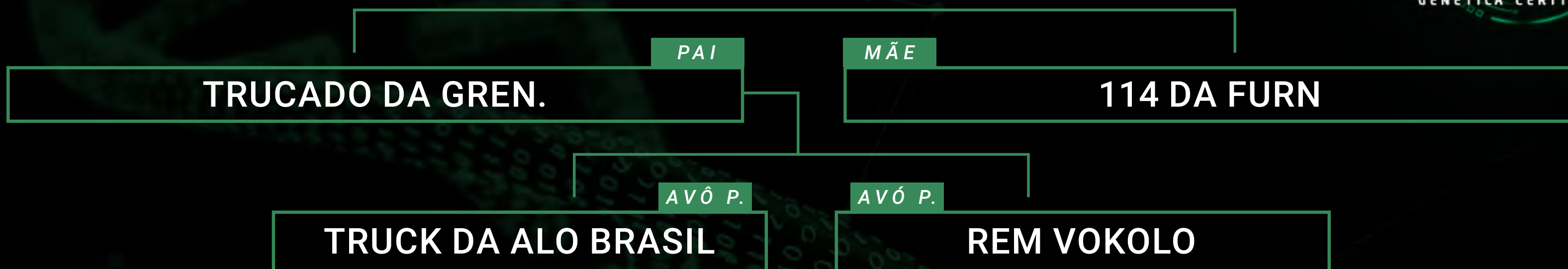

Clique no play para ver o vídeo



ANCP

MGTE:	TOP:	MP120:	DP210:	DP450:	DPE365:	DSTAY:	D3P:	DAOL:	DACAB:
30,08	0,5	2,12	14,28	31,6	1,72	90,64	80,94	3,24	0,22

PMGZ

iABCZ:	DECA:	PD-ED:	PS-ED:	PM-EM:	IPP:	STAY:	PE-450:	AOL:	ACAB:
24,93	1	9,98	21,90	1,95	-23,10	39,57	2,107	4,404	1,156

PRECOCIDADE

PE

AOL

ACAB



LOTE
20

RGN: GCGC305 | NASC.: 30/07/2020 | PESO: 711KG | CE: 40 | GENOTIPADO: G



305 TE DA FURN

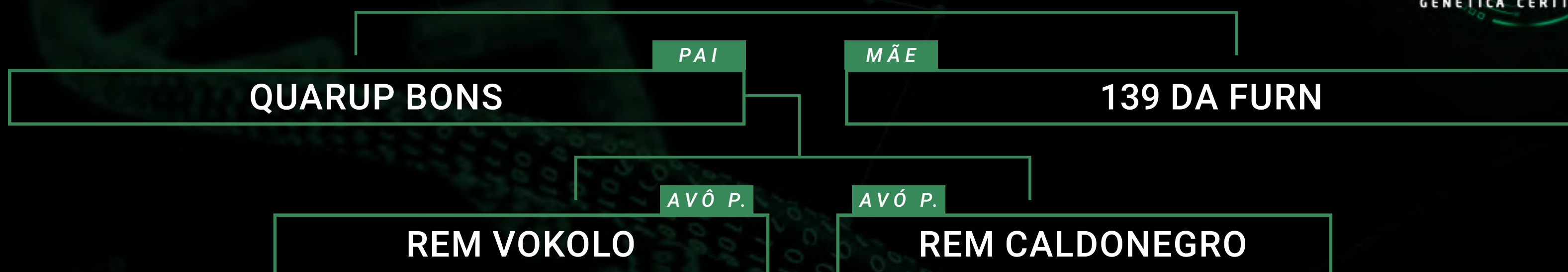

Clique no play para ver o vídeo

ANCP

MGTE:	TOP:	MP120:	DP210:	DP450:	DPE365:	DSTAY:	D3P:	DAOL:	DACAB:
29,94	0,5	6,58	14,92	30,1	1,56	83,54	90,43	2,18	1,01

PMGZ

iABCZ:	DECA:	PD-ED:	PS-ED:	PM-EM:	IPP:	STAY:	PE-450:	AOL:	ACAB:
28,92	1	10,12	23,29	4,67	-31,77	38,88	1,872	2,751	1,706

PRECOCIDADE

ACAB



LOTE
21

RGN: GCGC325 | NASC.: 02/11/2020 | PESO: 710KG | CE: 45 | GENOTIPADO: G



AMALFI TE GRUPO COSTA

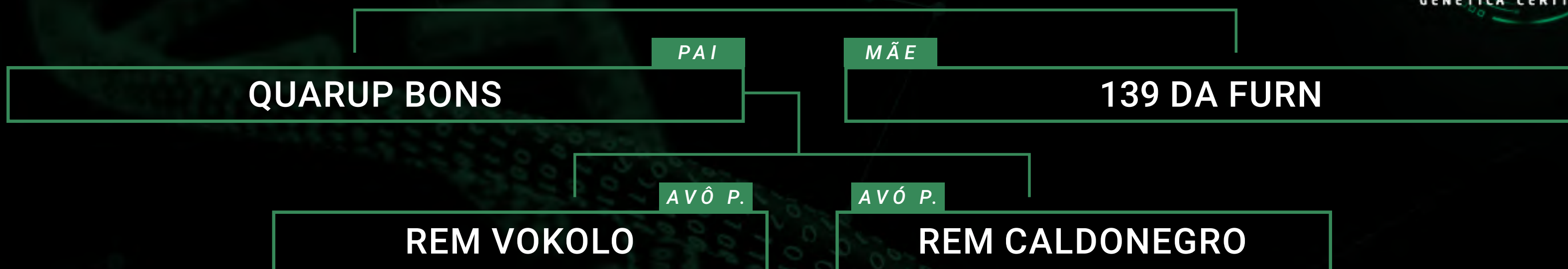

Clique no play para ver o vídeo



ANCP

MGTE:	TOP:	MP120:	DP210:	DP450:	DPE365:	DSTAY:	D3P:	DAOL:	DACAB:
35,7	0,1	5,34	22,64	37,98	2,02	93,44	75,12	3,74	1,04

PMGZ

iABCZ:	DECA:	PD-ED:	PS-ED:	PM-EM:	IPP:	STAY:	PE-450:	AOL:	ACAB:
28,92	1	10,12	23,29	4,67	-31,77	38,88	1,872	2,751	1,706

PRECOCIDADE

PESO

PE

AOL

ACAB



LOTE
22

RGN: GCGC245 | NASC.: 22/10/2019 | PESO: 765KG | CE: 36 | GENOTIPADO: G



245 DA FURN

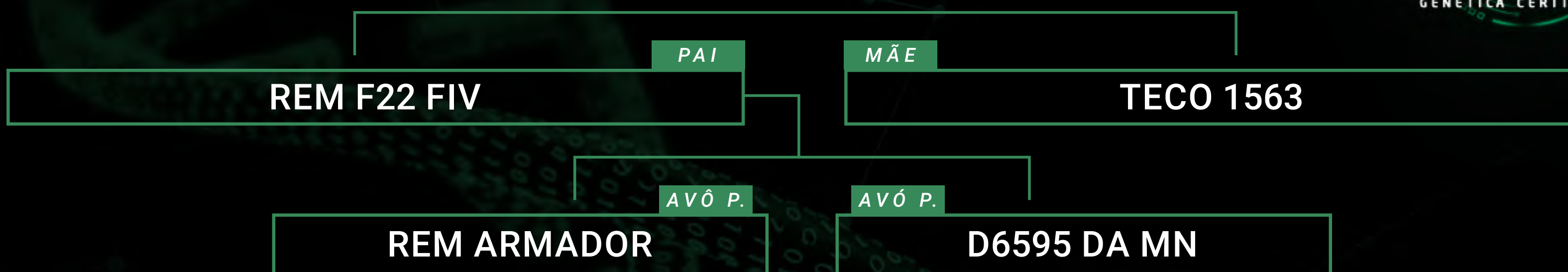

Clique no play para ver o vídeo



ANCP

MGTE:	TOP:	MP120:	DP210:	DP450:	DPE365:	DSTAY:	D3P:	DAOL:	DACAB:
23,96	3	2,66	10,72	21,61	0,7	89,31	69,37	4,46	0,75

PMGZ

iABCZ:	DECA:	PD-ED:	PS-ED:	PM-EM:	IPP:	STAY:	PE-450:	AOL:	ACAB:
17,96	1	6,41	16,86	1,65	-21,51	36,63	0,707	4,004	2,673

AOL

ACAB



LOTE
23

RGN: GCGC248 | NASC.: 27/10/2019 | PESO: 815KG | CE: 42 | GENOTIPADO: G



248 DA FURN

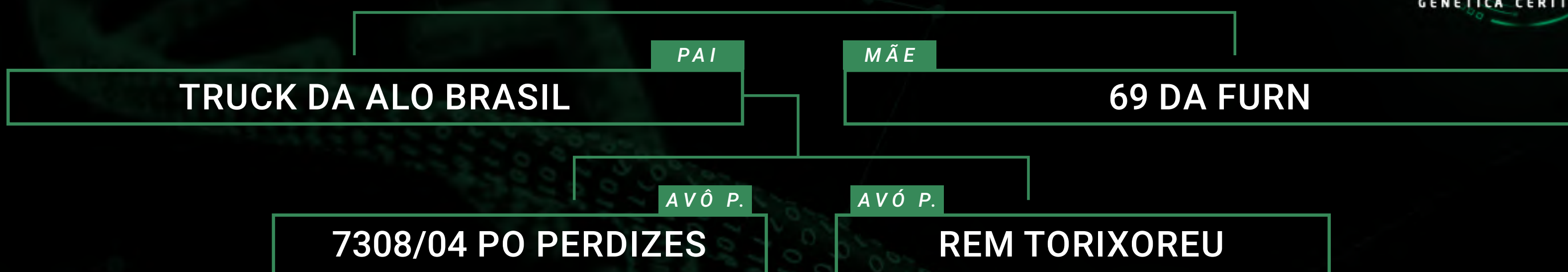

Clique no play para ver o vídeo



ANCP

MGTE:	TOP:	MP120:	DP210:	DP450:	DPE365:	DSTAY:	D3P:	DAOL:	DACAB:
31,12	0,5	5,01	16,36	31,89	1,73	89,92	77,88	2,57	0,46

PMGZ

iABCZ:	DECA:	PD-ED:	PS-ED:	PM-EM:	IPP:	STAY:	PE-450:	AOL:	ACAB:
25,99	1	11,08	23,14	4,35	-18,25	37,07	2,310	3,395	1,627

PRECOCIDADE

PESO

PE

ACAB



LOTE
24

RGN: GCGC293 | NASC.: 21/01/2020 | PESO: 771KG | CE: 38 | GENOTIPADO: G



293 DA FURN

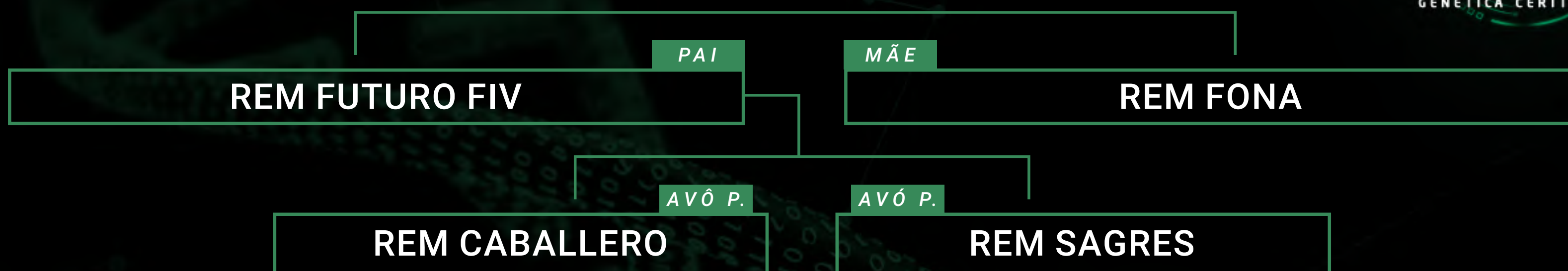

Clique no play para ver o vídeo

ANCP

MGTE:	TOP:	MP120:	DP210:	DP450:	DPE365:	DSTAY:	D3P:	DAOL:	DACAB:
25,44	2	2,22	13,74	23,68	1,18	89,85	80,47	1,02	0,59

PMGZ

iABCZ:	DECA:	PD-ED:	PS-ED:	PM-EM:	IPP:	STAY:	PE-450:	AOL:	ACAB:
22,1	1	10,82	24,35	1,60	-21,49	33,07	1,633	3,840	3,235

PRECOCIDADE

PE



LOTE
25

RGN: GCGC213 | NASC.: 05/08/2019 | PESO: 1000KG | CE: 47 | GENOTIPADO: G



ANGRI DA FURN

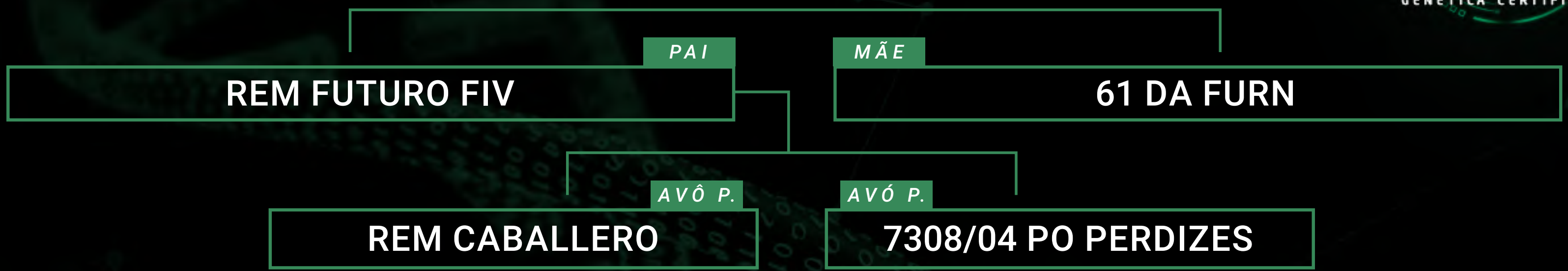

Clique no play para ver o vídeo



ANCP

MGTE:	TOP:	MP120:	DP210:	DP450:	DPE365:	DSTAY:	D3P:	DAOL:	DACAB:
30,67	0,5	0,67	21,15	39,66	1,27	82,96	65,18	4,94	0,7

PMGZ

iABCZ:	DECA:	PD-ED:	PS-ED:	PM-EM:	IPP:	STAY:	PE-450:	AOL:	ACAB:
23,74	1	13,90	26,15	1,73	-20,82	32,43	1,671	4,939	1,562

PRECOCIDADE

PESO

PE



LOTE
26

RGN: GCGC214 | NASC.: 06/08/2019 | PESO: 805KG | CE: 42 | GENOTIPADO: G



214 DA FURN

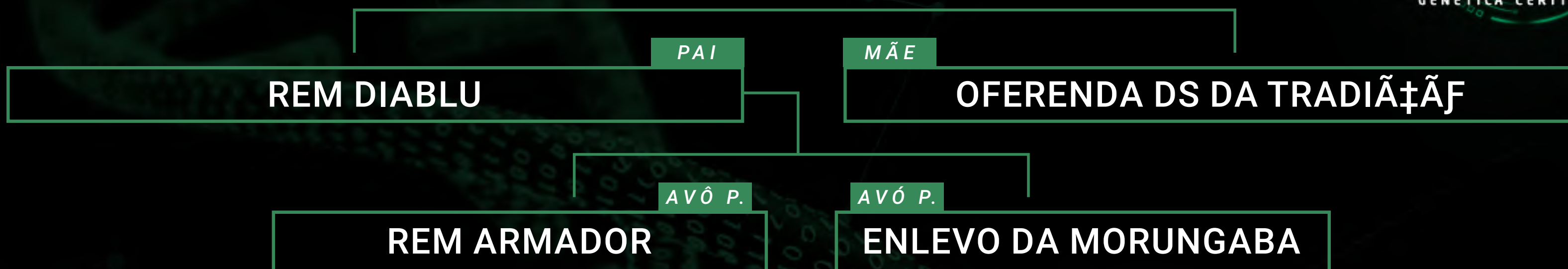

Clique no play para ver o vídeo



ANCP

MGTE:	TOP:	MP120:	DP210:	DP450:	DPE365:	DSTAY:	D3P:	DAOL:	DACAB:
14,82	19	2,3	7,61	17,41	0,81	78,29	52,58	-0,17	-0,12

PMGZ

iABCZ:	DECA:	PD-ED:	PS-ED:	PM-EM:	IPP:	STAY:	PE-450:	AOL:	ACAB:
11,85	1	1,62	9,56	2,08	-15,46	34,70	0,937	1,844	0,095

ACAB



LOTE
27

RGN: GCGC268 | NASC.: 28/11/2019 | PESO: 875KG | CE: 45 | GENOTIPADO: G



268 DA FURN

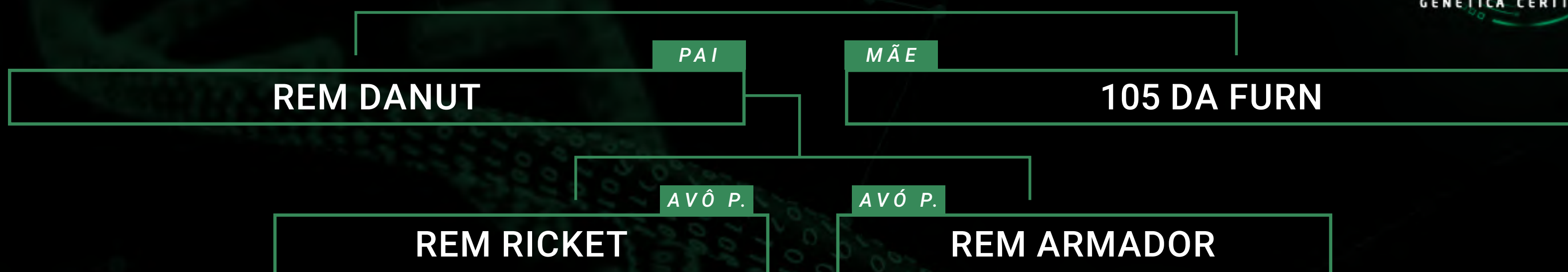

Clique no play para ver o vídeo



ANCP

MGTE:	TOP:	MP120:	DP210:	DP450:	DPE365:	DSTAY:	D3P:	DAOL:	DACAB:
27,58	1	3,36	14,95	25,27	0,87	89,34	84,6	1,92	0,7

PMGZ

iABCZ:	DECA:	PD-ED:	PS-ED:	PM-EM:	IPP:	STAY:	PE-450:	AOL:	ACAB:
26,82	1	13,71	23,52	2,08	-29,16	36,99	1,993	3,965	1,303

PRECOCIDADE

PESO

PE



LOTE
28

RGN: GCGC269 | NASC.: 28/11/2019 | PESO: 795KG | CE46,5 | GENOTIPADO: G



269 DA FURN

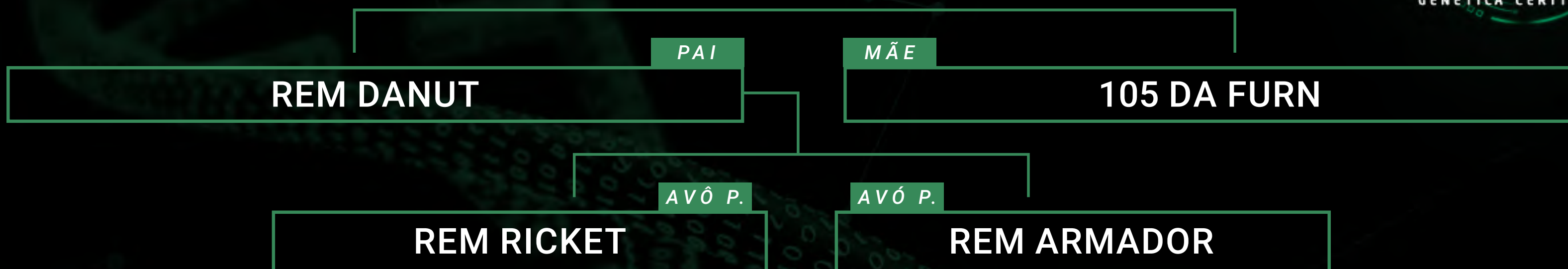

Clique no play para ver o vídeo



ANCP

MGTE:	TOP:	MP120:	DP210:	DP450:	DPE365:	DSTAY:	D3P:	DAOL:	DACAB:
26,61	2	3,38	14,03	23,59	0,8	88,41	84,97	1,97	0,65

PMGZ

iABCZ:	DECA:	PD-ED:	PS-ED:	PM-EM:	IPP:	STAY:	PE-450:	AOL:	ACAB:
26,82	1	13,71	23,52	2,08	-29,16	36,99	1,993	3,965	1,303

PRECOCIDADE

ACAB



LOTE
29

RGN: GCGC272 | NASC.: 29/11/2019 | PESO: 790KG | CE: 40 | GENOTIPADO: G



ALGHERO TE DA FURN

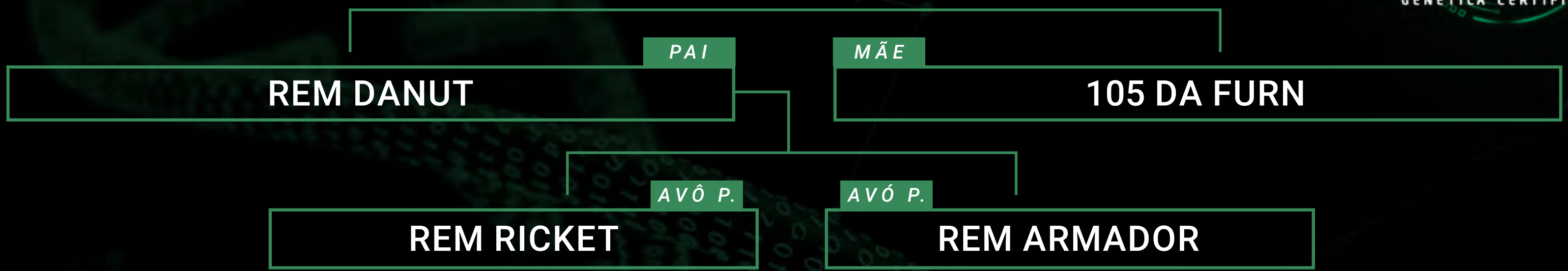

Clique no play para ver o vídeo



ANCP

MGTE:	TOP:	MP120:	DP210:	DP450:	DPE365:	DSTAY:	D3P:	DAOL:	DACAB:
28,75	0,5	5,48	16,78	27,08	1,49	88,26	83,68	0,67	0,72

PMGZ

iABCZ:	DECA:	PD-ED:	PS-ED:	PM-EM:	IPP:	STAY:	PE-450:	AOL:	ACAB:
26,82	1	13,71	23,52	2,08	-29,16	36,99	1,993	3,965	1,303

PRECOCIDADE

PE

ACAB



LOTE
30

RGN: GCGC244 | NASC.: 21/10/2019 | PESO: 745KG | CE: 37 | GENOTIPADO: G



244 DA FURN

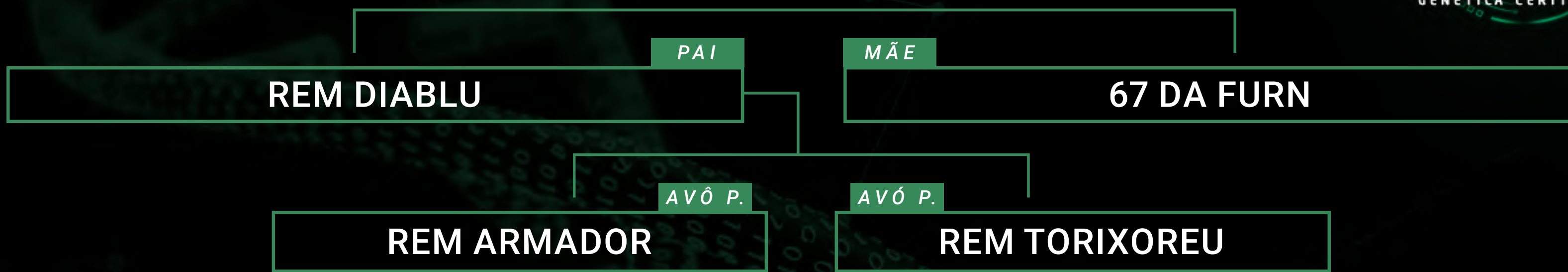

Clique no play para ver o vídeo



ANCP

MGTE:	TOP:	MP120:	DP210:	DP450:	DPE365:	DSTAY:	D3P:	DAOL:	DACAB:
21,36	6	4,09	10,41	22,63	1,29	77,77	59,7	3,75	-0,02

PMGZ

iABCZ:	DECA:	PD-ED:	PS-ED:	PM-EM:	IPP:	STAY:	PE-450:	AOL:	ACAB:
21,71	1	7,89	21,02	3,25	-19,54	36,00	1,628	3,438	0,736

AOL



LOTE
31

RGN: GCGC292 | NASC.: 21/01/2020 | PESO: 821KG | CE: 35 | GENOTIPADO: G



292 DA FURN

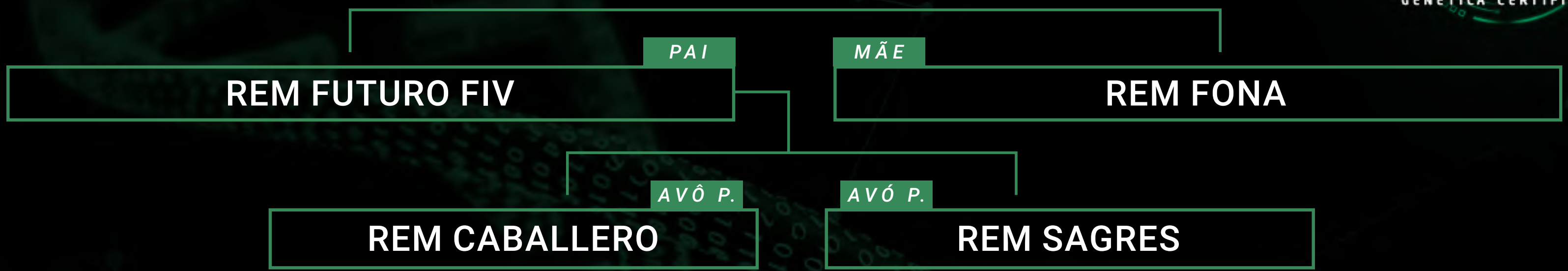

Clique no play para ver o vídeo



ANCP

MGTE:	TOP:	MP120:	DP210:	DP450:	DPE365:	DSTAY:	D3P:	DAOL:	DACAB:
24,93	3	0,47	15,65	27,37	1,07	84,75	74,55	1,22	0,36

PMGZ

iABCZ:	DECA:	PD-ED:	PS-ED:	PM-EM:	IPP:	STAY:	PE-450:	AOL:	ACAB:
22,1	1	10,82	24,35	1,60	-21,49	33,07	1,633	3,840	3,235

PRECOCIDADE

PESO

PE

ACAB



LOTE
32

RGN: GCGC294 | NASC.: 23/01/2020 | PESO: 769KG | CE: 41 | GENOTIPADO: G



294 DA FURN

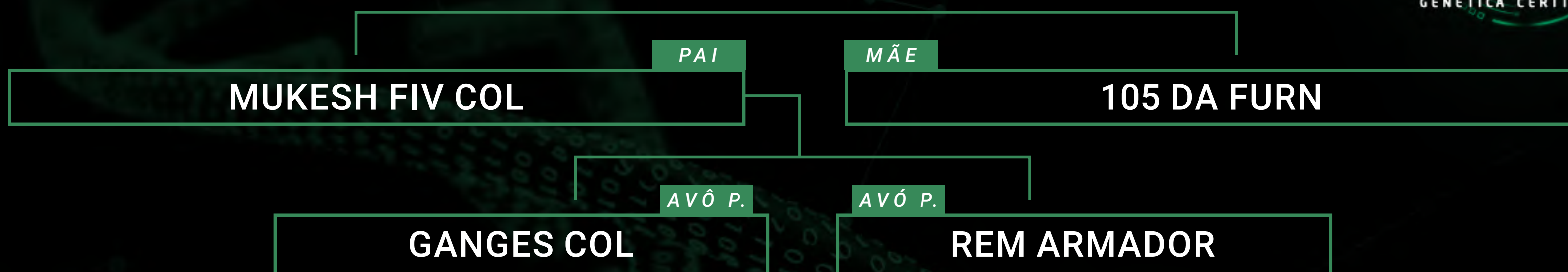

Clique no play para ver o vídeo

ANCP

MGTE:	TOP:	MP120:	DP210:	DP450:	DPE365:	DSTAY:	D3P:	DAOL:	DACAB:
26,41	2	3,05	15,34	30,3	0,17	83,55	81,01	1,59	0,57

PMGZ

iABCZ:	DECA:	PD-ED:	PS-ED:	PM-EM:	IPP:	STAY:	PE-450:	AOL:	ACAB:
19,6	1	9,75	21,03	1,56	-21,98	32,74	1,542	3,350	0,861

PRECOCIDADE

PESO

AOL



LOTE
33

RGN: GCGC279 | NASC.: 18/12/2019 | PESO: 785KG | CE: 38 | GENOTIPADO: G



279 DA FURN

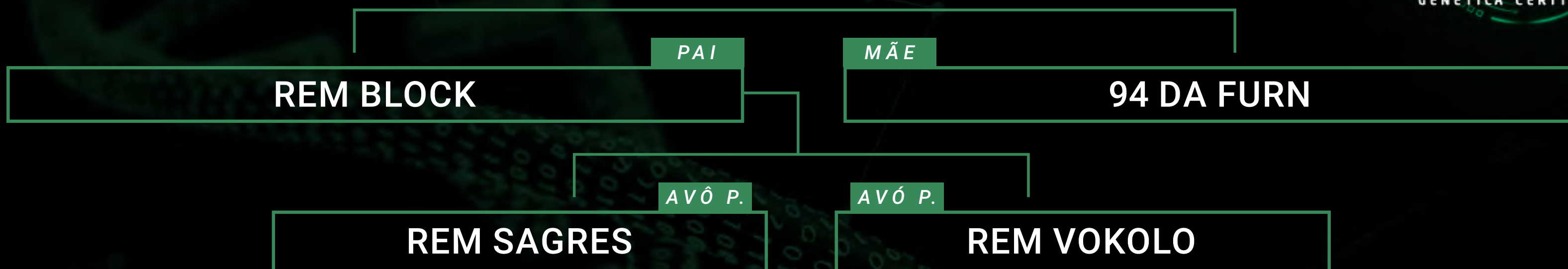

Clique no play para ver o vídeo



ANCP

MGTE:	TOP:	MP120:	DP210:	DP450:	DPE365:	DSTAY:	D3P:	DAOL:	DACAB:
22,97	4	2,73	13,04	21,84	0,81	85,25	74,01	1,23	-0,35

PMGZ

iABCZ:	DECA:	PD-ED:	PS-ED:	PM-EM:	IPP:	STAY:	PE-450:	AOL:	ACAB:
22	1	6,69	20,08	3,23	-18,31	39,12	1,391	3,341	0,099

PRECOCIDADE



1º LEILÃO
NELORE
GRUPO
COSTA

GENÉTICA CERTIFICADA

FÊMEAS



GRUPOCOSTA
GENÉTICA NELORE CERTIFICADA

LOTE
34

RGN: GCGC256 | NASC.: 19/11/2019 | PESO: 660KG | GENOTIPADO: G

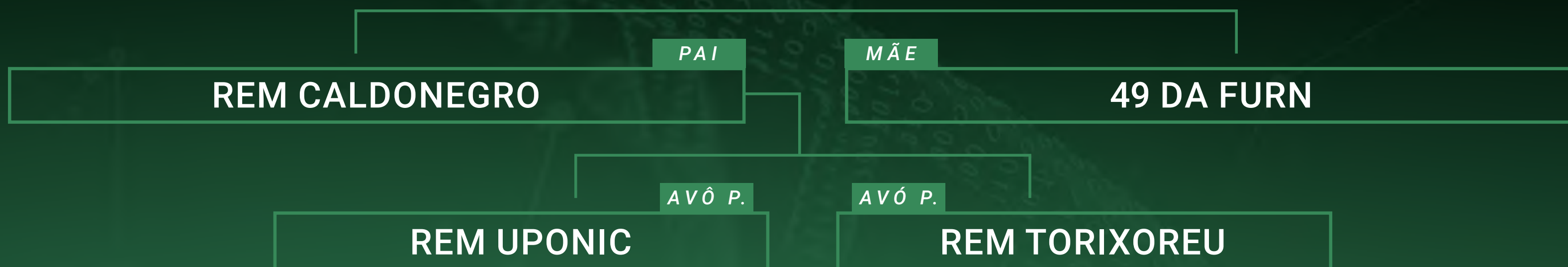

256 DA FURN



Clique no play para ver o vídeo



ANCP

MGTE:	TOP:	MP120:	DP210:	DP450:	DPE365:	DSTAY:	D3P:	DAOL:	DACAB:
25,28	2	5,86	17,6	31,08	1,24	79	56,01	0,81	0,68

PMGZ

iABCZ:	DECA:	PD-ED:	PS-ED:	PM-EM:	IPP:	STAY:	PE-450:	AOL:	ACAB:
30,53	1	12,88	28,17	4,71	-20,99	40,27	1,596	2,230	3,443

TOURO: ESCANDINAVO MAT

DATA IA: 08/10/2021 | MGTE: 28,14 | TOP: 1%

LOTE
35

RGN: GCGC259 | NASC.: 21/11/2019 | PESO: 620KG | GENOTIPADO: G



ARDEA TE DA FURN

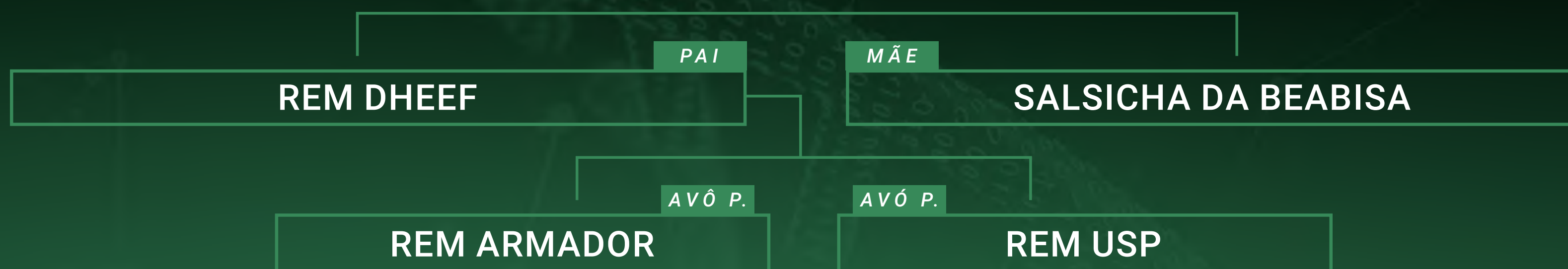

Clique no play para ver o vídeo



ANCP

MGTE:	TOP:	MP120:	DP210:	DP450:	DPE365:	DSTAY:	D3P:	DAOL:	DACAB:
27,72	1	-3,26	21,52	32,4	1,38	84,64	74,55	2,03	0,54

PMGZ

iABCZ:	DECA:	PD-ED:	PS-ED:	PM-EM:	IPP:	STAY:	PE-450:	AOL:	ACAB:
23,17	1	13,37	24,06	-2,77	-19,38	39,40	1,185	3,700	1,111

TOURO: LBMN D8306 MN

DATA IA: 29/12/2021 MGTE: 24,77 TOP: 3%

LOTE
36

RGN: GCGC261 | NASC.: 21/11/2019 | PESO: 600KG | GENOTIPADO: G



261 DA FURN

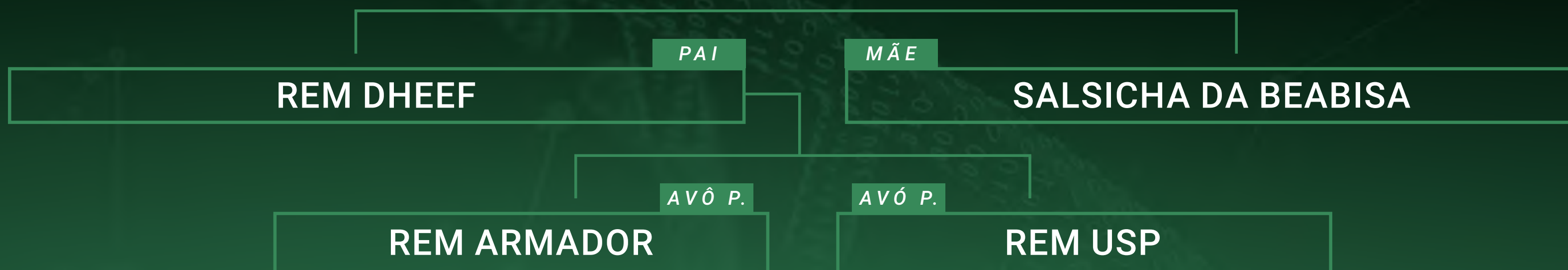

Clique no play para ver o vídeo



ANCP

MGTE:	TOP:	MP120:	DP210:	DP450:	DPE365:	DSTAY:	D3P:	DAOL:	DACAB:
28,74	0,5	-4,17	17,81	31,26	0,99	91,03	85,34	2,93	0,5

PMGZ

iABCZ:	DECA:	PD-ED:	PS-ED:	PM-EM:	IPP:	STAY:	PE-450:	AOL:	ACAB:
23,17	1	13,37	24,06	-2,77	-19,38	39,40	1,185	3,700	1,111

TOURO: LBMN D8306 MN

DATA IA: 05/02/2022 MGTE: 25,36 TOP: 2%

LOTE
37

RGN: GCGC104 | NASC.: 21/10/2017 | PESO: 700KG | GENOTIPADO: G



104 DA FURN

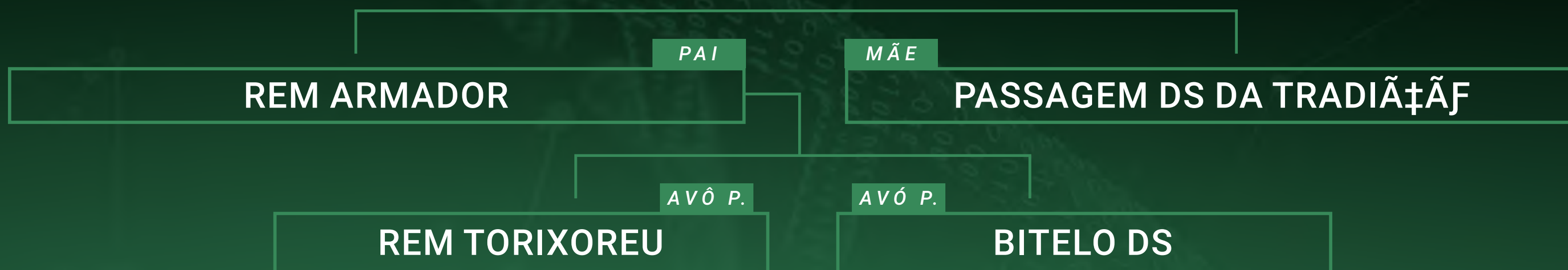

Clique no play para ver o vídeo



ANCP

MGTE:	TOP:	MP120:	DP210:	DP450:	DPE365:	DSTAY:	D3P:	DAOL:	DACAB:
24,31	3	0,65	13,24	25,62	1,12	89,07	73,76	0,8	0,7

PMGZ

iABCZ:	DECA:	PD-ED:	PS-ED:	PM-EM:	IPP:	STAY:	PE-450:	AOL:	ACAB:
19,56	1	4,01	13,74	1,98	-23,22	40,36	1,520	2,336	1,130

TOURO: REM HERMOSO

DATA IA: 13/01/2022 MGTE: 28,83 TOP: 0,5%

LOTE
38

RGN: GCGC200 | NASC.: 22/01/2019 | PESO: 530KG | GENOTIPADO: G



200 DA FURN

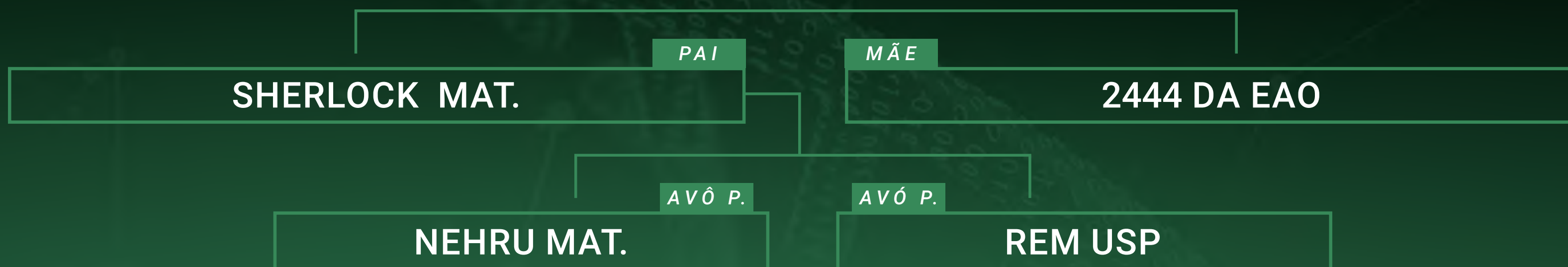

Clique no play para ver o vídeo



ANCP

MGTE:	TOP:	MP120:	DP210:	DP450:	DPE365:	DSTAY:	D3P:	DAOL:	DACAB:
22,03	5	1,62	9,38	16,19	1,35	92,61	79,89	-0,17	0,34

PMGZ

iABCZ:	DECA:	PD-ED:	PS-ED:	PM-EM:	IPP:	STAY:	PE-450:	AOL:	ACAB:
20,49	1	9,35	20,28	2,33	-17,90	33,84	1,782	2,143	0,918

TOURO: DIPLOMATA DA AGRONOVA

DATA IA: 08/10/2021 | MGTE: 31,24 | TOP: 0,5%

LOTE
38

RGN: GCGC273 | NASC.: 29/11/2019 | PESO: 600KG | GENOTIPADO: G



ARESE TE DA FURN

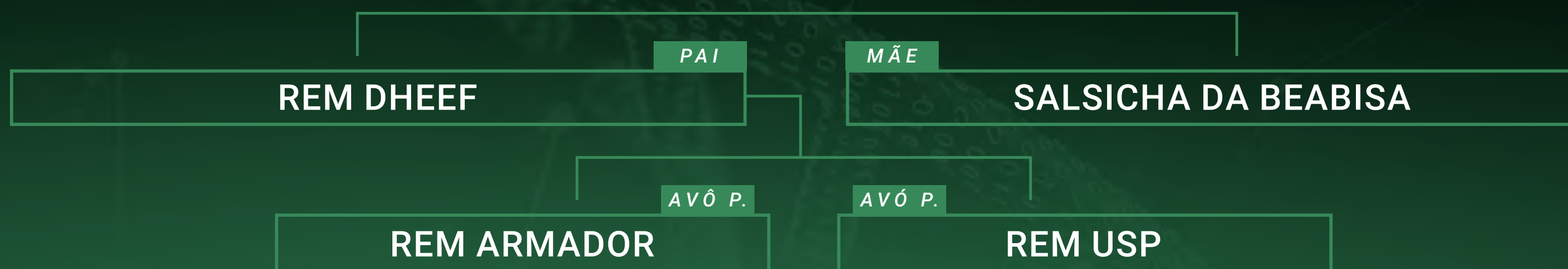

Clique no play para ver o vídeo



ANCP

MGTE:	TOP:	MP120:	DP210:	DP450:	DPE365:	DSTAY:	D3P:	DAOL:	DACAB:
25,81	2	-3,38	17,02	32,36	0,81	86,3	72,99	2,75	0,49

PMGZ

iABCZ:	DECA:	PD-ED:	PS-ED:	PM-EM:	IPP:	STAY:	PE-450:	AOL:	ACAB:
23,17	1	13,37	24,06	-2,77	-19,38	39,40	1,185	3,700	1,111

TOURO: ASTI TE DA FURN

DATA IA: 27/01/2022 MGTE: 28,93 TOP: 0,5%

LOTE
39

RGN: GCGC252 | NASC.: 30/10/2019 | PESO: 440KG | GENOTIPADO: G



252 DA FURN

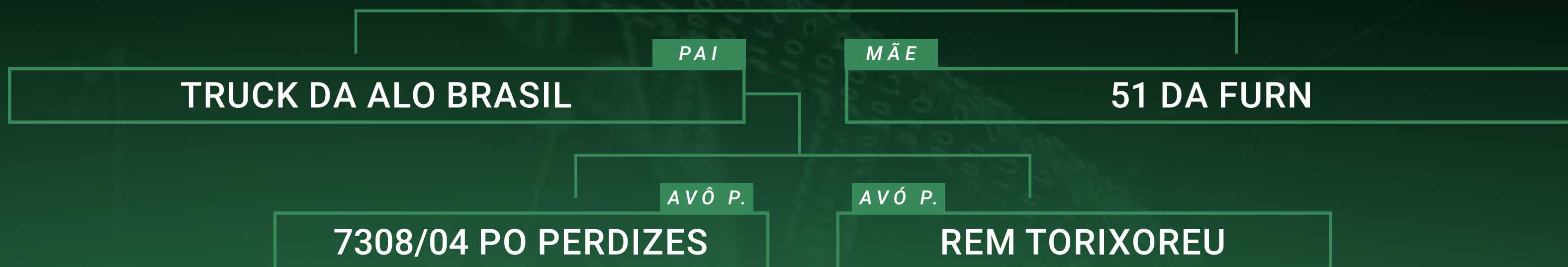

Clique no play para ver o vídeo



ANCP

MGTE:	TOP:	MP120:	DP210:	DP450:	DPE365:	DSTAY:	D3P:	DAOL:	DACAB:
20,07	8	4,84	5,57	12,15	2,15	84,92	76,59	1,21	0,88

PMGZ

iABCZ:	DECA:	PD-ED:	PS-ED:	PM-EM:	IPP:	STAY:	PE-450:	AOL:	ACAB:
21,76	1	7,30	19,07	3,82	-19,71	37,07	1,959	3,209	1,549

TOURO: FABULOSO GADALUPE

DATA IA: 29/12/2021 MGTE: 28,03 TOP: 1%

LOTE
40

RGN: GCGC225 | NASC.: 04/09/2019 | PESO: 445KG | GENOTIPADO: G



225 DA FURN

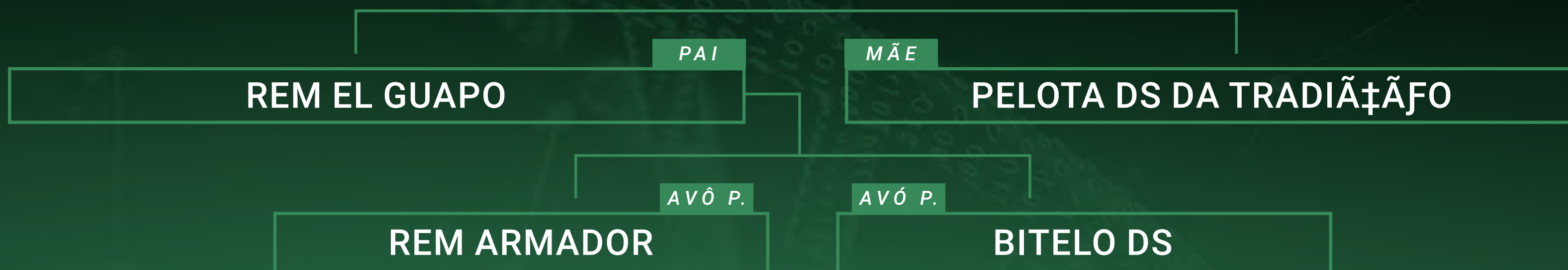

Clique no play para ver o vídeo



ANCP

MGTE:	TOP:	MP120:	DP210:	DP450:	DPE365:	DSTAY:	D3P:	DAOL:	DACAB:
17,34	13	1,24	6,73	13,96	1,11	85,91	69,59	-0,78	0,24

PMGZ

iABCZ:	DECA:	PD-ED:	PS-ED:	PM-EM:	IPP:	STAY:	PE-450:	AOL:	ACAB:
15,78	1	2,79	13,63	2,58	-24,33	34,81	1,149	1,875	1,036

TOURO: ASTI TE DA FURN

DATA IA: 24/04/2022 MGTE: 25,75 TOP: 2%

LOTE
40

RGN: GCGC242 | NASC.: 27/09/2019 | PESO: 460KG | GENOTIPADO: G



242 DA FURN

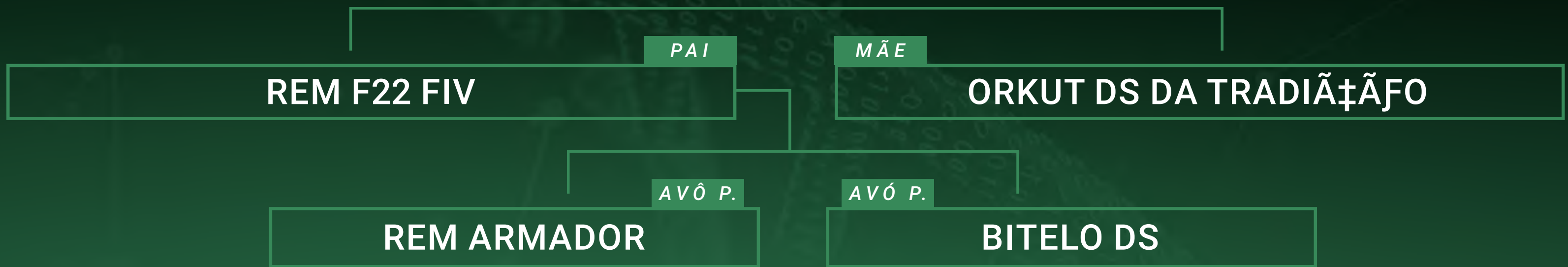

Clique no play para ver o vídeo



ANCP

MGTE:	TOP:	MP120:	DP210:	DP450:	DPE365:	DSTAY:	D3P:	DAOL:	DACAB:
20,8	7	3,7	11,3	19,95	1,36	80,26	65,86	1,09	0,29

PMGZ

iABCZ:	DECA:	PD-ED:	PS-ED:	PM-EM:	IPP:	STAY:	PE-450:	AOL:	ACAB:
18,2	1	6,58	19,07	1,27	-19,65	35,53	1,192	2,905	1,688

TOURO: ASCOLI TE DA FURN

DATA IA: 05/02/2022 MGTE: 29,22 TOP: 0,5%

LOTE
41

RGN: GCGC197 | NASC.: 17/01/2019 | PESO: 500KG | GENOTIPADO: G



197 DA FURN

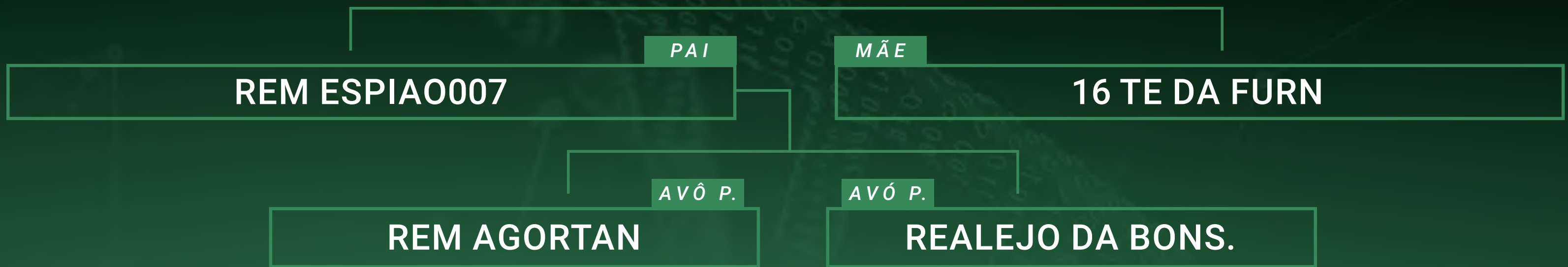

Clique no play para ver o vídeo



ANCP

MGTE:	TOP:	MP120:	DP210:	DP450:	DPE365:	DSTAY:	D3P:	DAOL:	DACAB:
20,52	7	2,7	13,04	21,07	1,44	69,06	77,37	0,92	0,47

PMGZ

iABCZ:	DECA:	PD-ED:	PS-ED:	PM-EM:	IPP:	STAY:	PE-450:	AOL:	ACAB:
17,76	1	7,62	14,59	2,65	-17,14	34,15	1,707	2,025	3,356

TOURO: TROOPER DA ALO BRASIL

DATA IA: 08/10/2021 MGTE: 27,25 TOP: 1%

LOTE
41

RGN: GCGC205 | NASC.: 27/07/2019 | PESO: 460KG | GENOTIPADO: G



205 DA FURN

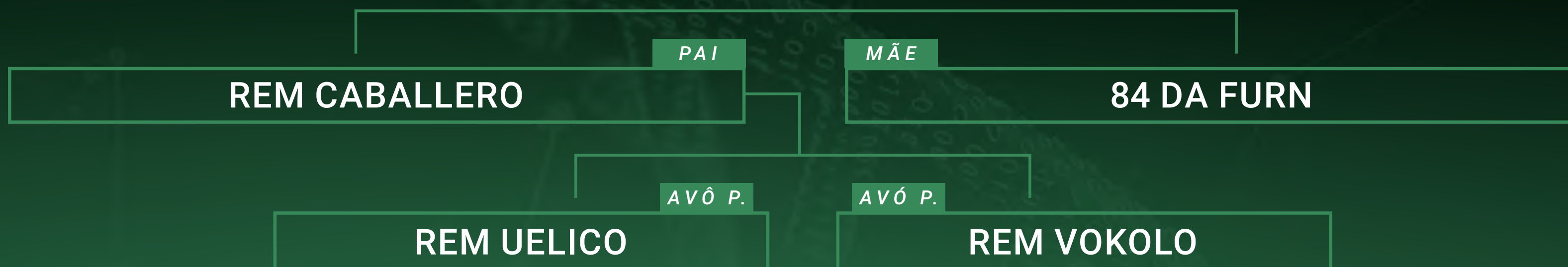

Clique no play para ver o vídeo



ANCP

MGTE:	TOP:	MP120:	DP210:	DP450:	DPE365:	DSTAY:	D3P:	DAOL:	DACAB:
23,19	4	3,43	7,44	19,12	1,51	89,61	79,05	1,87	0,62

PMGZ

iABCZ:	DECA:	PD-ED:	PS-ED:	PM-EM:	IPP:	STAY:	PE-450:	AOL:	ACAB:
23,72	1	10,41	24,54	1,68	-18,28	36,72	1,961	4,936	1,108

TOURO: FLEXOR GUADALUPE

DATA IA: 29/12/2021 MGTE: 24,1 TOP: 3%

LOTE
42

RGN: GCGC182 | NASC.: 19/11/2018 | PESO: 490KG | GENOTIPADO: G



182 DA FURN

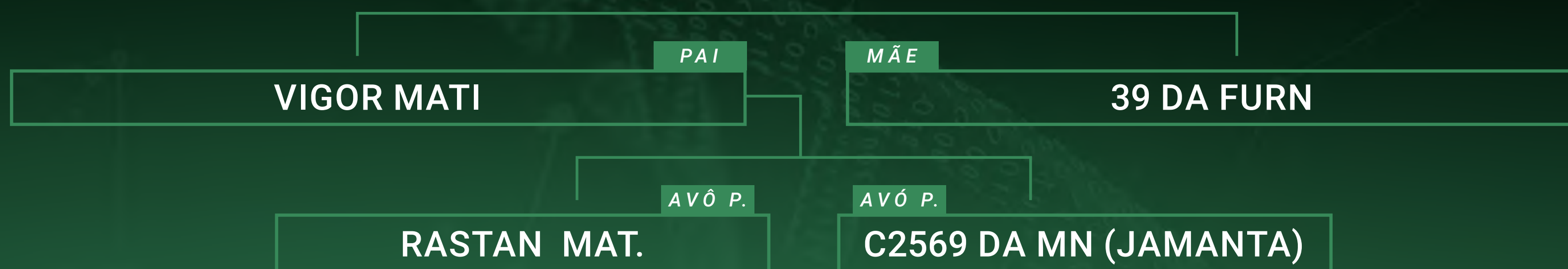

Clique no play para ver o vídeo



ANCP

MGTE:	TOP:	MP120:	DP210:	DP450:	DPE365:	DSTAY:	D3P:	DAOL:	DACAB:
13,97	21	1,22	8,63	14,84	0,3	81,24	56,91	-1,48	0,47

PMGZ

iABCZ:	DECA:	PD-ED:	PS-ED:	PM-EM:	IPP:	STAY:	PE-450:	AOL:	ACAB:
13,35	1	5,45	13,01	1,96	-9,61	34,72	0,254	1,396	0,927

TOURO: TROOPER DA ALO BRASIL

DATA IA: 08/10/2021 MGTE: 24,1 TOP: 3%

LOTE
43

RGN: GCGC150 | NASC.: 13/08/2018 | PESO: 585KG | GENOTIPADO: G



150 DA FURN

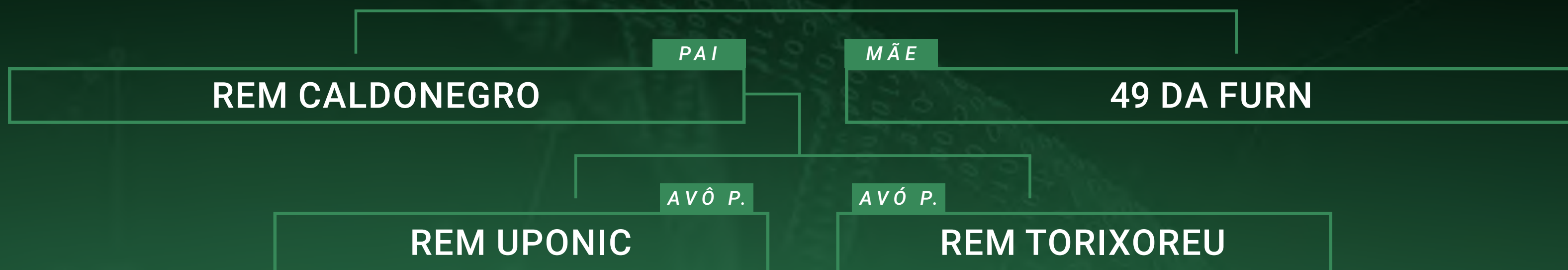

Clique no play para ver o vídeo



ANCP

MGTE:	TOP:	MP120:	DP210:	DP450:	DPE365:	DSTAY:	D3P:	DAOL:	DACAB:
24,24	3	4,87	13,85	26,64	1,03	80,16	71,85	1,36	0,7

PMGZ

iABCZ:	DECA:	PD-ED:	PS-ED:	PM-EM:	IPP:	STAY:	PE-450:	AOL:	ACAB:
30,72	1	12,71	27,99	4,64	-23,63	40,27	1,589	2,230	3,443

TOURO: ESTORIL MAT

DATA IA: 22/12/2021 MGTE: 28,43 TOP: 1%

LOTE
44

RGN: GCGC193 | NASC.: 12/01/2019 | PESO: 640KG | GENOTIPADO: G



193 DA FURN

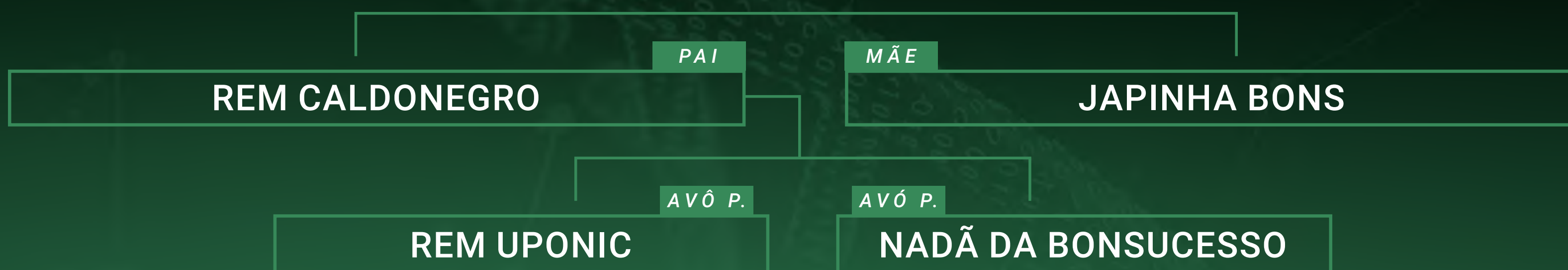

Clique no play para ver o vídeo



ANCP

MGTE:	TOP:	MP120:	DP210:	DP450:	DPE365:	DSTAY:	D3P:	DAOL:	DACAB:
18,95	10	1,83	11,39	21,84	1,1	68,46	69,85	1,54	0,32

PMGZ

iABCZ:	DECA:	PD-ED:	PS-ED:	PM-EM:	IPP:	STAY:	PE-450:	AOL:	ACAB:
26,72	1	11,13	22,96	4,16	-17,45	39,75	1,494	1,131	2,565

TOURO: ANZIO DA FURN

DATA IA: 24/04/2022 MGTE: 26,35 TOP: 2%

LOTE
45

RGN: GCGC105 | NASC.: 24/10/2017 | PESO: 690KG | GENOTIPADO: G



105 DA FURN

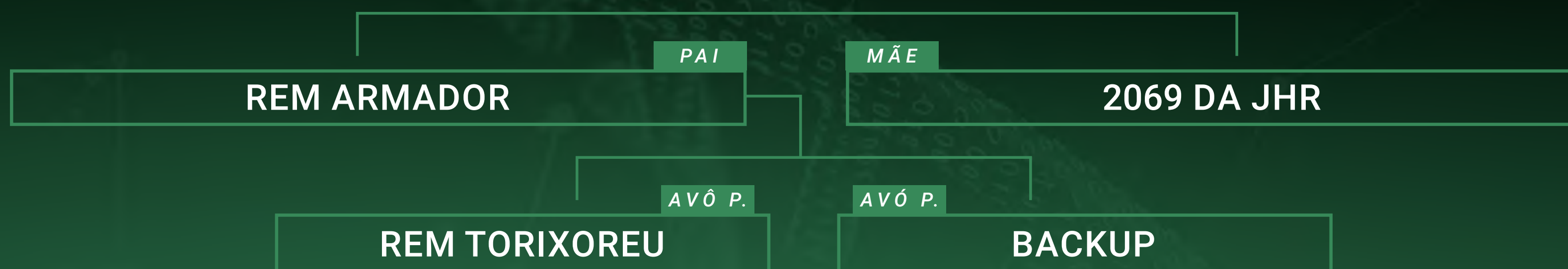

Clique no play para ver o vídeo



ANCP

MGTE:	TOP:	MP120:	DP210:	DP450:	DPE365:	DSTAY:	D3P:	DAOL:	DACAB:
27,76	1	3,65	13,85	29,58	0,88	86,59	78,4	2,51	0,86

PMGZ

iABCZ:	DECA:	PD-ED:	PS-ED:	PM-EM:	IPP:	STAY:	PE-450:	AOL:	ACAB:
27,29	1	10,91	22,80	2,88	-26,81	40,01	1,867	3,882	1,923

TOURO: FABULOSO FIV GUADALUPE

DATA IA: 29/12/2021 MGTE: 31,89 TOP: 0,1%

LOTE
46

RGN: GCGC51 | NASC.: 02/01/2016 | PESO: 595KG | GENOTIPADO: G



51 DA FURN

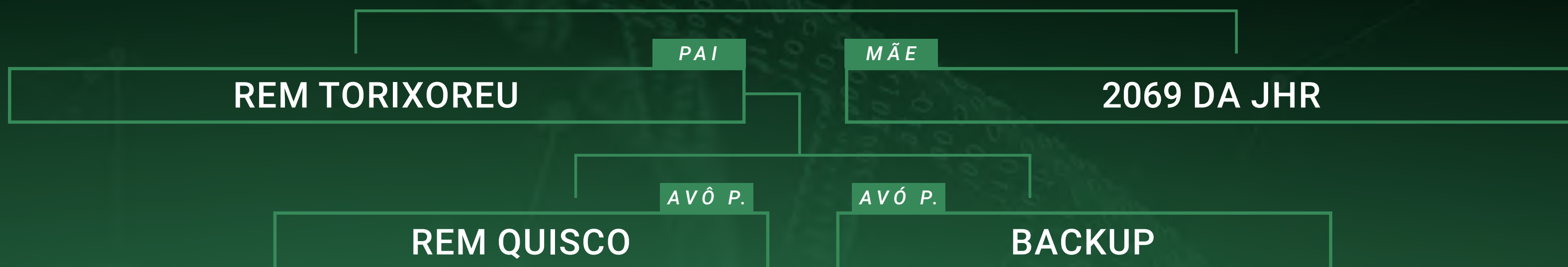

Clique no play para ver o vídeo



ANCP

MGTE:	TOP:	MP120:	DP210:	DP450:	DPE365:	DSTAY:	D3P:	DAOL:	DACAB:
20,62	7	3,71	6,03	16,52	1,65	81,08	82,11	1,22	0,62

PMGZ

iABCZ:	DECA:	PD-ED:	PS-ED:	PM-EM:	IPP:	STAY:	PE-450:	AOL:	ACAB:
20,74	1	8,53	21,74	2,47	-19,40	34,97	1,595	2,958	1,778

TOURO: EL ZORRERO SINO

DATA IA: 05/02/2022 MGTE: 26,97 TOP: 1%

LOTE
47

RGN: GCGC335 | NASC.: 15/12/2020 | PESO: 390KG | GENOTIPADO: G



335 DA FURN

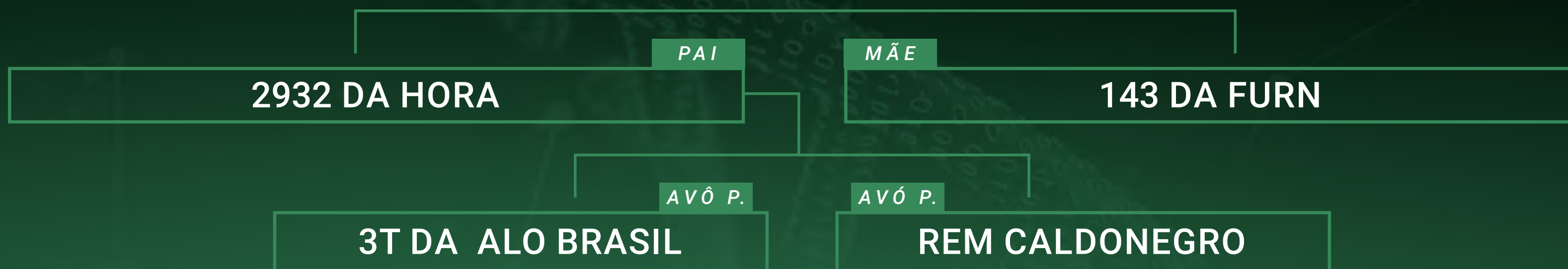

Clique no play para ver o vídeo



ANCP

MGTE:	TOP:	MP120:	DP210:	DP450:	DPE365:	DSTAY:	D3P:	DAOL:	DACAB:
24,4	3	4,27	13,45	25,06	0,95	81,09	76,66	2,23	0,84

PMGZ

iABCZ:	DECA:	PD-ED:	PS-ED:	PM-EM:	IPP:	STAY:	PE-450:	AOL:	ACAB:
25,62	1	10,32	20,68	4,31	-23,60	38,61	1,322	2,110	2,160

TOURO: ASTI TE DA FURN

DATA IA: 27/01/2022 MGTE: 28,17 TOP: 1%

LOTE
48

RGN: GCGC336 | NASC.: 16/12/2020 | PESO: 415KG | GENOTIPADO: G



336 DA FURN

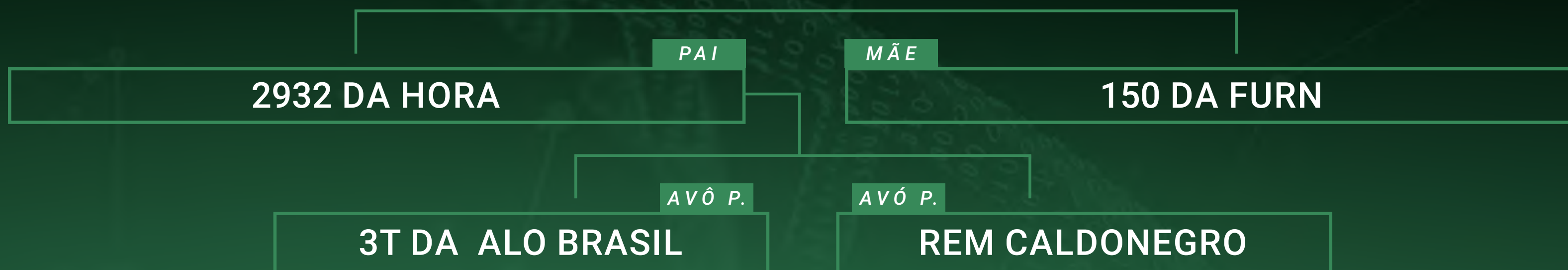

Clique no play para ver o vídeo



ANCP

MGTE:	TOP:	MP120:	DP210:	DP450:	DPE365:	DSTAY:	D3P:	DAOL:	DACAB:
23,43	4	5,69	14,45	26,89	0,59	77,54	75,9	-0,18	0,53

PMGZ

iABCZ:	DECA:	PD-ED:	PS-ED:	PM-EM:	IPP:	STAY:	PE-450:	AOL:	ACAB:
24,77	1	9,44	19,75	4,24	-23,77	38,61	1,281	2,110	2,160

TOURO: REM HERMOSO

DATA IA: 24/04/2022 MGTE: 28,27 TOP: 1%

GRUPOCOSTA
GENÉTICA NELORE CERTIFICADA