

DE OLHO NA FAZENDA

11 A 17 DE MAIO

LEILÃO TABAPUÃ COPACABANA

17 de Maio | quarta-feira - 20h



100 TOUROS
70 NOVILHAS PRENHES

REALIZAÇÃO



LEILOEIRAS



PATROCÍNIO



TRANSMISSÃO



RETRANSMISSÃO



LEILÃO TABAPUÃ COPACABANA

REGULAMENTO DO LEILÃO

O presente regulamento estabelecerá as normas que serão observadas durante o leilão, sendo que seu cumprimento será obrigatório a todos aqueles que, na condição de convidados, participantes e/ou promotores do evento, quiserem promover a aquisição ou venda de animal(is) ou produto(s) agrobusiness, ou como mero espectador.

1. DEFINIÇÕES

1.1 Considera-se LEILÃO o evento que visa a comercialização de animal(is) e/ou produto(s), pela melhor oferta de valores, efetuada de forma aberta e aceita por um leiloeiro.

1.2 Considera-se EMPRESA LEILOEIRA a empresa responsável pela organização e coordenação do leilão. O presente leilão será coordenado e organizado pela Central Leiloes Ltda.

1.3 Considera-se LEILOEIRO a pessoa inscrita no Sindicato Nacional dos Leiloeiros Rurais, detentor de fé-pública, e que será responsável pela recepção das propostas de ofertas aos lotes comercializados, bem como pela batida do martelo e concretização do negócio.

1.4 Considera-se PROMOTOR DO EVENTO a(s) pessoa(s), física(s) ou jurídica(s), que for(em) responsável(is) pela promoção do evento e arrematação do(s) animal(is) ou produto(s) para serem comercializados no leilão.

1.5 Considera-se CONVIDADO a pessoa, física ou jurídica, que for proprietária de animal(is) ou produto(s) que será(o) comercializado(s) no leilão. Ao convidado também será permitida a realização de compras no leilão.

1.6 Considera-se PARTICIPANTE todo aquele que comparecer no leilão e que tenha interesse na compra de animal(is) ou produto(s) comercializado(s) no evento, ou como mero espectador.

1.7 Considera-se COMISSÃO DE COMPRA a comissão paga pelo comprador do(s) animal(is) / produto(s) à EMPRESA LEILOEIRA, que será anunciada pelo leiloeiro no início do leilão, cujo percentual incidirá sobre o valor total de cada lote apregoado.

1.8 Considera-se COMISSÃO DE VENDA a comissão paga pelo proprietário do(s) animal(is) / produto(s) ao PROMOTOR DO EVENTO / EMPRESA LEILOEIRA.

1.9 Considera-se PRODUTO tudo que não seja semovente e que possa ser comercializado em leilão, tais como: embrião, sêmen, etc.

1.10 Considera-se LANCE DE DEFESA o lance ofertado pelo próprio proprietário do animal(is) ou produto(s), quando não alcançado o preço esperado por este junto ao leilão. Nesta hipótese, o proprietário será responsável pelo pagamento das comissões de compra e venda acima previstas.

1.11 Considera-se LOTE o grupo de animais ou o animal individualmente e/ou de produtos a serem colocados à venda através de leilão, devidamente identificado no catálogo.

2. CADASTRO:

2.1 Todo aquele que pretenda apresentar lance no leilão deverá estar previamente cadastrado junto à Central Leiloes Ltda, podendo encaminhar tal solicitação à empresa leiloeira com antecedência, para fins de análise e aprovação prévia dos cadastros. Nesta hipótese, o pedido de cadastramento importará em autorização automática à empresa leiloeira de consulta de informações do solicitante junto ao SERASA ou outros órgãos de proteção ao crédito.

2.2 A Central Leiloes Ltda disponibilizará aos convidados e participantes um escritório no local do evento, podendo o cadastro ser efetuado neste local. Nesta hipótese, toda compra efetuada pelo convidado ou participante ficará condicionada à posterior aprovação do cadastro, bem como aceitação pelo VENDEDOR.

2.3 A presença dos convidados ou participantes no recinto do leilão importará em imediata autorização à Central Leiloes Ltda em promover consultas sobre os mesmos junto ao SERASA ou outros órgãos de proteção ao crédito.

2.4 Os empregados da Central Leiloes Ltda não estão autorizados a avalizar ou endossar qualquer comprador junto ao leilão.

2.5 A existência de cadastro não dispensará a necessidade de apresentação de avalista, caso seja solicitado pelo VENDEDOR ou pela Central Leiloes Ltda.

2.6 Será permitida a compra de animal(is) / produto(s) mediante procuração por Instrumento Público, a qual deverá ser específica para aquele evento e deverá conter o valor máximo autorizado pelo outorgante e desde que este possua cadastro aprovado junto à Central Leiloes Ltda, que permanecerá com referida procuração.

2.7 A Central Leiloes Ltda atua como intermediária das transações, sendo responsável pela organização e coordenação do evento, não se responsabilizando pelo inadimplemento do comprador, seja em relação ao valor do(s) produto(s) / animal(is) adquirido(s), seja em relação às comissões de venda. Portanto, cabe ao vendedor manifestar-se sobre o cadastro do comprador antes da assinatura do contrato de compra e venda, bem como exigir a assinatura de avalista antes da formalização deste contrato.

3. DO LEILOEIRO:

3.1 O leilão será realizado por um LEILOEIRO RURAL, devidamente inscrito nos órgãos próprios, sendo que a venda considerará efetuada com a batida do martelo, momento em que as partes, compradores e vendedores, estarão obrigados ao cumprimento do negócio fechado, exceto na hipótese de não aprovação do cadastro do comprador, na forma do item 02 supra.

3.2 Poderá o leiloeiro, durante o leilão, promover as alterações das presentes normas, estabelecer outras regras, alterar as disposições do catálogo, de lotes ou condições de pagamento, instituir preços mínimos, sem direito de reclamação ou indenização por parte dos convidados ou participantes.

4. DISPOSIÇÕES ESPECÍFICAS PARA LEILÃO DE PRENHEZES:

4.1 Salvo estipulação em contrário, nos casos de livre acasalamento ou embrião a ser coletado, a primeira parcela será considerada como sinal de negócio e devidas no ato. As demais parcelas somente poderão ser exigidas do(s) COMPRADOR(es) após o recebimento ou a retirada da(s) prenhez(es) confirmada(s). Caso o VENDEDOR tenha recebido antecipadamente alguma parcela e a prenhez não consiga se realizar o VENDEDOR restituirá ao(s) COMPRADOR(es) o valor recebido.

4.2. PRENHEZES RECEPTORAS:

4.2.1. O VENDEDOR se responsabiliza em apresentar a(s) receptora(s) em perfeitas condições físicas, com boa habilidade maternal, a fim de bem criar o embrião.

4.2.2. O COMPRADOR, por sua vez, se compromete a mantê-la(s) sob as mesmas condições de manejo e trato, a fim de não prejudicar o desenvolvimento do embrião adquirido.

4.2.3. O COMPRADOR deverá comunicar imediatamente o VENDEDOR em caso de óbito da receptora e/ou da "cria", bem como de qualquer intercorrência que venha a surgir durante o período gestacional.

4.3. EMBRIÕES A SEREM COLETADOS:

4.3.1. É de responsabilidade de VENDEDOR a coleta e transferência do referido acasalamento, tendo o prazo máximo de 90 dias para a entrega da receptora prenhe, a contar da data da assinatura do presente Contrato, findo o qual poderá o COMPRADOR optar, em comum acordo com o VENDEDOR, escolher outro acasalamento já realizado, de igual importância e valor.

4.4. LIVRES ACASALAMENTOS:

4.4.1. O VENDEDOR oferece a doadora para ser acasalada com o touro da escolha do COMPRADOR, ficando a mesma na propriedade do titular.

4.4.2. O COMPRADOR tem o prazo máximo de 30 dias para enviar o sêmen do reprodutor escolhido, ou autorizar o proprietário da doadora a acasalá-la segundo seu critério.

4.4.3. Todas as despesas provenientes do transporte e aquisição de sêmen que porventura possam ocorrer, serão de inteira responsabilidade do COMPRADOR.

4.4.4. Do acasalamento em questão o COMPRADOR terá direito a apenas uma prenhez proveniente da lavagem, salvo disposição em contrário e acordado entre as partes. Terá também direito a optar se tal prenhez será sexada de macho ou fêmea.

4.4.5. O VENDEDOR garante ao COMPRADOR que a prenhez adquirida venha a nascer com saúde, com garantia de receber RGN (registro geral de nascimento) e RGD (registro geral definitivo).

4.4.6. Caso o produto nascido não preencha os requisitos mencionados no item anterior, deverá o VENDEDOR substituir o produto, caso não possua o mesmo acasalamento, de comum acordo com o COMPRADOR, substituí-lo por outro já nascido de igual categoria e valor.

4.5 A(s) prenhez(es) será(ão) entregue(s) por malha viária, podendo ainda o COMPRADOR retirá-la da propriedade de origem, sob sua conta e responsabilidade.

LEILÃO TABAPUÃ COPACABANA

CONTINUAÇÃO DA PÁGINA ANTERIOR...

5. DISPOSIÇÕES ESPECÍFICAS PARA LEILÃO DE SÊMEN:

5.1. O VENDEDOR responde pela qualidade do sêmen de animal de sua propriedade posto a venda.

5.2. Todo lote de sêmen deverá estar à disposição do COMPRADOR para ser retirado em local previamente estipulado. Nos casos em que a entrega do sêmen for feita por empresa de coleta, as despesas decorrentes deste procedimento correrão por conta e risco COMPRADOR. Quando o sêmen de animal, comercializado for do estoque particular do VENDEDOR, o COMPRADOR deverá providenciar botijão para o transporte, correndo por conta deste todo e qualquer risco.

5.3. Caso queira, poderá o COMPRADOR, no ato da retirada, testar a qualidade do sêmen adquirido, em sendo este raro, desde que seja realizado por profissionais credenciados por uma das centrais de coleta do país.

6. DISPOSIÇÕES GERAIS PARA TODOS OS LEILÕES:

6.1. O leiloeiro apregoará, no início de cada lote, o valor do lance que, multiplicado pelo número de parcelas determinadas, formará o preço total de venda e compra do(s) animal(is)/ produto(s). Também será informada a condição de cada venda, data de vencimento das parcelas, condições gerais do(s) produto(s) ou a(s) condição(ões) física(s) do(s) animal(is) referentes a cada lote.

6.2. Os leilões referentes à gado de elite, embrião e sêmen serão realizados com CLÁUSULA DE RESERVA DE DOMÍNIO, que abrangerá inclusive as "crias" advindas destes, conforme disposto no artigo 95 do Código Civil.

6.3. Excetuando o disposto no item 2. deste Regulamento (aprovação de cadastro), as vendas efetuadas durante o leilão são irrevogáveis e irrevogáveis, obrigando comprador e vendedor ao seu cumprimento, por si e por seus herdeiros ou sucessores.

6.4. Ainda que existente índice deflacionário divulgado pelo Governo Federal, os preços estabelecidos no leilão não serão alterados.

6.5. Caberá ao comprador o pagamento do ICMS e ao vendedor o recolhimento do mesmo, referente ao lote adquirido, devendo o segundo informar a Central Leiloes Ltda o número de inscrição junto à Receita Estadual.

6.6. A participação no leilão de qualquer pessoa, seja comprador ou vendedor, implicará na presunção de aceitação de todas as normas previstas neste Regulamento, e, face disponibilização deste Regulamento a todos que se encontram presentes no recinto do leilão através do catálogo, não poderá alegar desconhecimento para eximir de seu cumprimento.

6.7. Compradores domiciliados fora do país deverão informar-se no escritório sobre as condições que regem a compra e venda, que no caso presente somente se operará com o pagamento à vista, em moeda corrente do país, no ato do negócio.

6.8. Salvo estabelecido de forma diversa, por escrito, antes do leilão, o comprador será responsável pelo pagamento da comissão de compra, a qual recai sobre o valor do lote no momento da batida do martelo, em favor da EMPRESA LEILOEIRA, cujo percentual será divulgado pelo leiloeiro no início do evento.

6.9. Salvo estabelecido de forma diversa, por escrito, antes do leilão, o vendedor será responsável pelo pagamento da comissão de venda, a qual recai sobre o valor do lote no momento da batida do martelo, em favor do PROMOTOR DO EVENTO / EMPRESA LEILOEIRA, cujo percentual foi acordado anteriormente entre as partes.

6.10. As taxas do leilão, assim como as comissões, para comprador e vendedor, são irrevogáveis e irrevogáveis. No caso da não concretização do negócio após o remate, a parte responsável pelo cancelamento do negócio arcará com as mesmas em sua totalidade.

6.11. Em caso de pagamento à vista das parcelas de compra, o desconto poderá ser concedido pelo vendedor, mas tal desconto não recairá sobre as comissões em favor da Leiloeira.

6.12. No lance de defesa, conforme definição do item 1.10 deste regulamento, o proprietário do animal será responsável pelo pagamento da comissão de compra e venda em favor do PROMOTOR DO EVENTO / EMPRESA LEILOEIRA, sobre o valor do lote no momento da batida do martelo.

6.13. Não serão aceitos pagamentos das parcelas vencíveis no ato da compra com cheques de terceiros.

6.14. Todos os pagamentos efetuados em cheque somente serão considerados quitados com a respectiva compensação.

6.15. As GTAS (Guias de Trânsito dos Animais) serão emitidas exclusivamente em nome do comprador e não poderão ser transferidas a terceiros.

6.16. Os catálogos do leilão são de responsabilidade dos vendedores, não sendo a Central Leiloes Ltda responsável por eventuais erros constantes nestes, os quais inclusive poderão ser retificados pelo leiloeiro.

6.17. Quando da batida do martelo os lances forem simultâneos entre dois compradores, o leiloeiro pedirá o retorno do animal à pista e reiniciará a

venda dos mesmos, a partir do lance em questão, para o desempate.

6.18. Serão de exclusiva responsabilidade do vendedor, o(s) animal(ais) colocado(s) a leilão estar(em) saudável(eis), com toda documentação sanitária atualizada, bem como a sua guarda, manutenção e segurança, durante o tempo em que se mantiver(em) no local do leilão, seja no estábulo, em trânsito ou enquanto estiverem sendo exibidos na pista, até o momento da batida do martelo, passando então tais responsabilidades a serem exclusivas do comprador, não restando à Central Leiloes Ltda nenhum ônus sobre os itens retro mencionados, bem como em caso de acidente e danos que, eventualmente, venha(m) a ocorrer com o(s) animal(is).

6.19. No caso de comercialização efetuada através de canal fechado de televisão (Leilões Virtuais), o vendedor compromete-se a entregar o(s) animal(is) (independente do local de entrega), somente quando tiver em sua posse a respectiva documentação de venda, devidamente assinada pelo comprador, eximindo a Central Leiloes Ltda de qualquer responsabilidade se a presente cláusula não for cumprida.

7. DA AUTORIZAÇÃO DE USO DO NOME, IMAGEM E VOZ DOS PRESENTES AO LEILÃO:

7.1. A entrada da pessoa no recinto do leilão importará na presunção em favor da EMPRESA LEILOEIRA e do PROMOTOR DO EVENTO, sem ônus a estes, ao uso de seus NOMES, IMAGENS e SOM durante a realização do evento, bem como após a ocorrência deste para fins de divulgação do resultado final alcançado. Autorizam, também, a divulgação em periódicos e em site de todas as informações referentes ao leilão, tais como: nome do comprador, do vendedor, do animal ou produto comercializado e o valor efetivo da transação. Finalmente, fica autorizada a gravação de todas as imagens do leilão e dos participantes, bem como a transmissão ao vivo destas por canal fechado de televisão e, ainda, a divulgação de fotos em periódicos e em site próprio da EMPRESA LEILOEIRA.

8. DO CONTRATO DE COMPRA E VENDA:

8.1. Ao final da venda de cada lote a Central Leiloes Ltda promoverá a emissão do contrato de compra e venda, bem como das notas promissórias referentes ao leilão, as quais serão assinadas imediatamente pelo vendedor e comprador. As notas fiscais referentes às vendas, que deverão ser emitidas pelos vendedores, bem como a nota fiscal da comissão de compra a ser emitida pela empresa leiloeira, serão efetuadas posteriormente.

8.2. Ficam fazendo parte integrante do contrato de compra e venda todas as regras constantes neste regulamento, bem como outras que forem estabelecidas pelo leiloeiro durante o leilão.

"É proibida a reprodução em parte ou no todo".



LEILÃO TABAPUÃ COPACABANA

R\$ **450,00**
x 30 parcelas
(2+2+2+2+2+2+18)
Valor por parcela

LOTE

01

9990 DA COPAC.

SEXO: **MACHO** - RAÇA: **TABAPUÃ PO** - REG: **GER 9990** - NASC.: **20/10/2019**
PESO: **705 KG** - PE: **37 CM**

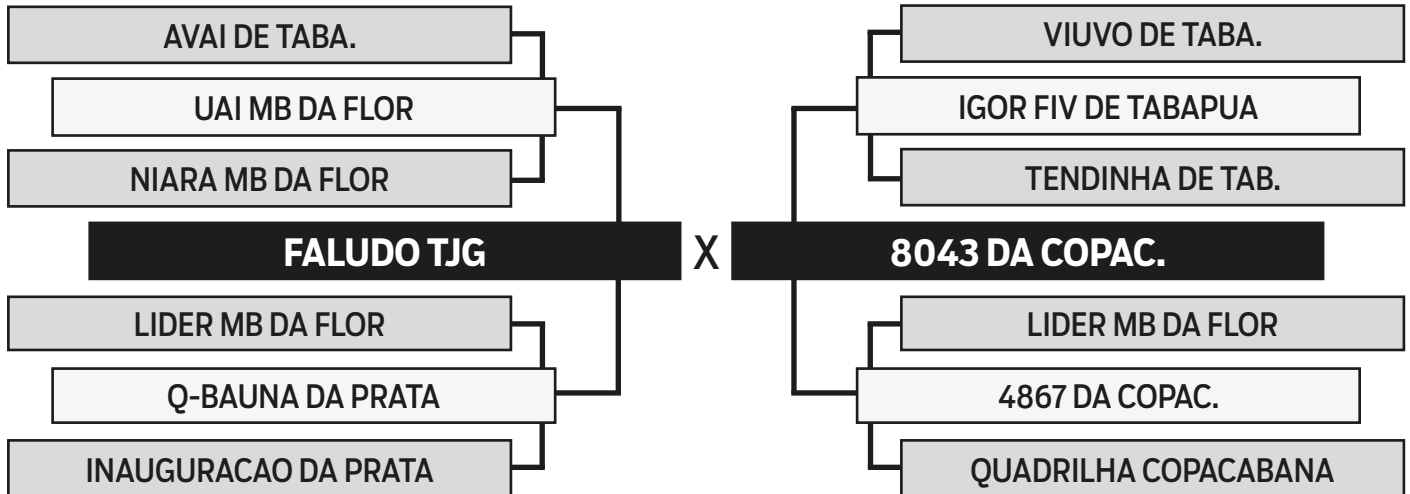

AVALIAÇÃO GENÉTICA - PMGZ



iABCZ: **13.71** - DECA: **1**

	PD-ED	PA-ED	PS-ED	PM-EM	TMD	IPP	STAY	PE-365	AOL	ACAB
DEP	5.19	8.88	11.68	1.09	4.90	-4.74	33.33	0.30	1.07	1.72
DECA	1	1	1	3	1	3	3	1	1	1



LEILÃO TABAPUÃ COPACABANA

R\$ **470,00**
x 30 parcelas
(2+2+2+2+2+2+18)
Valor por parcela

LOTE

02

7 DA COPAC.

SEXO: **MACHO** - RAÇA: **TABAPUÃ PO** - REG: **GER A7** - NASC.: **08/11/2019**
PESO: **695 KG** - PE: **37 CM**

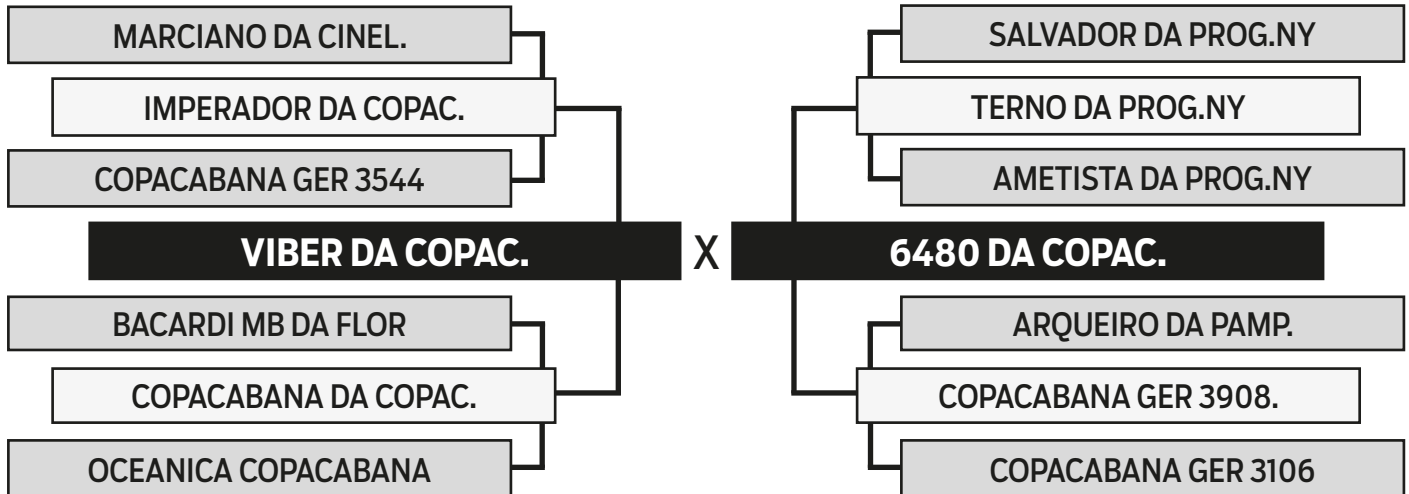

AVALIAÇÃO GENÉTICA - PMGZ



iABCZ: **16.77** - DECA: **1**

	PD-ED	PA-ED	PS-ED	PM-EM	TMD	IPP	STAY	PE-365	AOL	ACAB
DEP	5.87	7.85	12.79	0.80	4.38	-6.46	35.00	0.36	1.08	0.58
DECA	1	1	1	3	1	3	1	1	1	3



LEILÃO TABAPUÃ COPACABANA

R\$ **500,00**
x 30 parcelas
(2+2+2+2+2+2+18)
Valor por parcela

LOTE

03

38 DA COPAC.

SEXO: **MACHO** - RAÇA: **TABAPUÃ PO** - REG: **GER A38** - NASC.: **25/11/2019**
PESO: **640 KG** - PE: **33 CM**

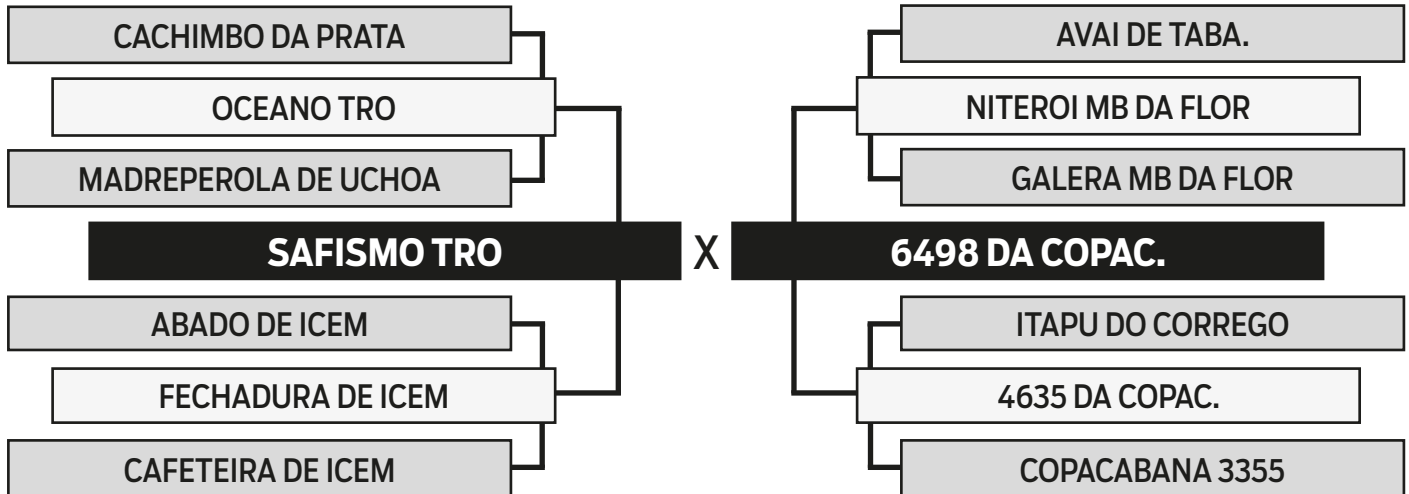

AVALIAÇÃO GENÉTICA - PMGZ



iABCZ: **2.41** - DECA: **5**

	PD-ED	PA-ED	PS-ED	PM-EM	TMD	IPP	STAY	PE-365	AOL	ACAB
DEP	2.77	5.67	4.77	0.63	1.93	4.06	30.80	-0.11	0.84	1.59
DECA	3	2	3	4	4	8	7	8	2	1



LEILÃO TABAPUÃ COPACABANA

R\$ **450,00**
x 30 parcelas
(2+2+2+2+2+2+18)
Valor por parcela

LOTE

04

A67 DA COPAC.

SEXO: **MACHO** - RAÇA: **TABAPUÃ PO** - REG: **GER A67** - NASC.: **18/01/2020**
PESO: **641 KG** - PE: **38 CM**

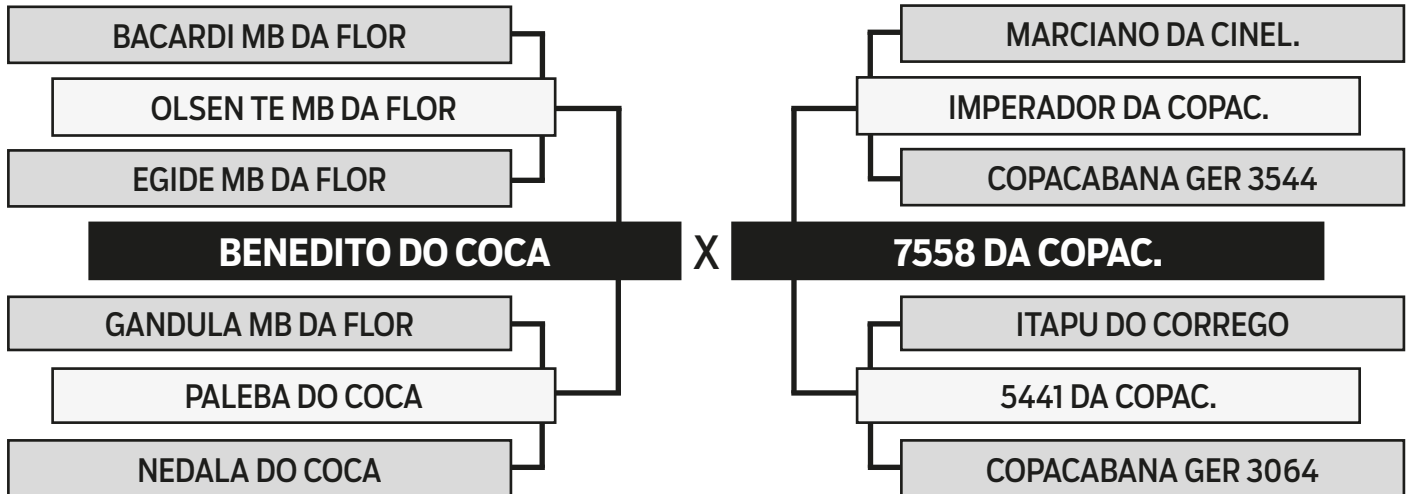

AVALIAÇÃO GENÉTICA - PMGZ



iABCZ: **14.68** - DECA: **1**

	PD-ED	PA-ED	PS-ED	PM-EM	TMD	IPP	STAY	PE-365	AOL	ACAB
DEP	3.33	6.53	11.48	0.50	2.73	-2.74	36.12	0.07	1.32	-0.31
DECA	3	1	1	4	3	4	1	4	1	7



LEILÃO TABAPUÃ COPACABANA

R\$ **500,00**
x 30 parcelas
(2+2+2+2+2+2+18)
Valor por parcela

LOTE

05

A72 DA COPAC.

SEXO: **MACHO** - RAÇA: **TABAPUÃ PO** - REG: **GER A72** - NASC.: **21/01/2020**
PESO: **690 KG** - PE: **39 CM**

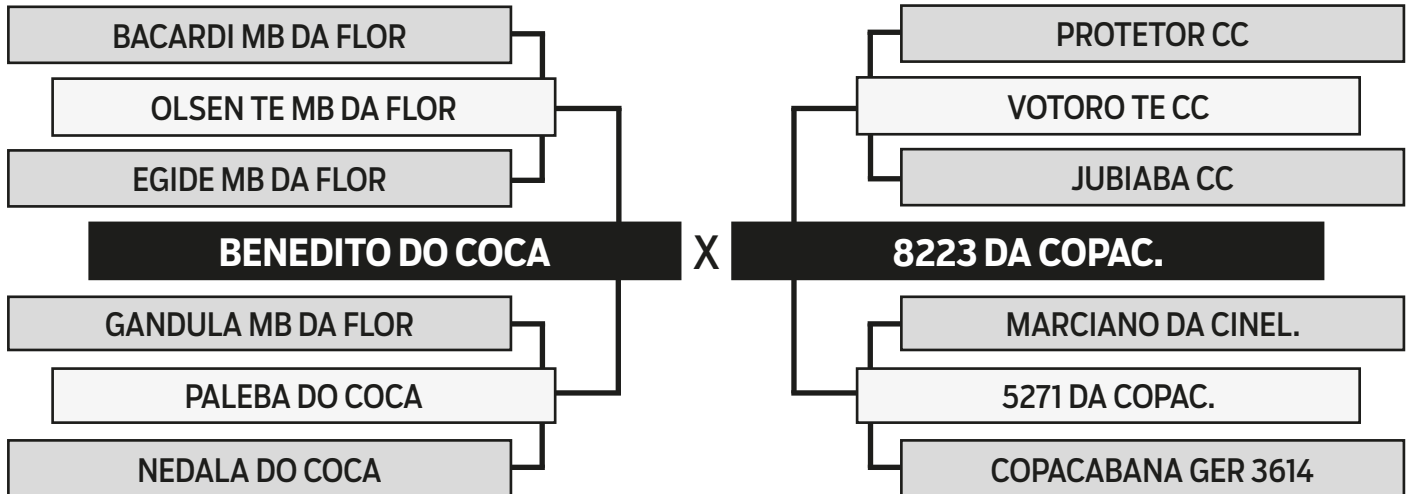

AVALIAÇÃO GENÉTICA - PMGZ



iABCZ: **10.68** - DECA: **1**

	PD-ED	PA-ED	PS-ED	PM-EM	TMD	IPP	STAY	PE-365	AOL	ACAB
DEP	3.16	6.69	9.31	0.78	2.72	-4.49	33.66	0.03	0.67	-0.41
DECA	3	1	1	3	3	4	2	5	2	8



LEILÃO TABAPUÃ COPACABANA

R\$ **500,00**
x 30 parcelas
(2+2+2+2+2+2+18)
Valor por parcela

LOTE

06

A76 DA COPAC.

SEXO: MACHO - RAÇA: TABAPUÃ PO - REG: GER A76 - NASC.: 22/01/2020
PESO: 705 KG - PE: 35 CM

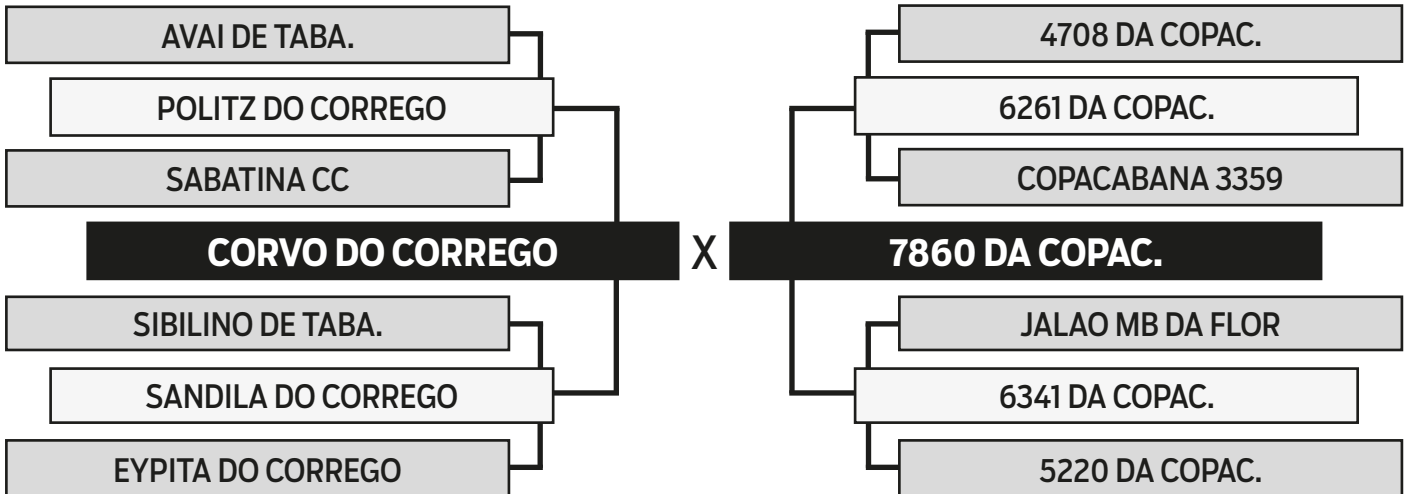

AVALIAÇÃO GENÉTICA - PMGZ



iABCZ: **16.71** - DECA: **1**

	PD-ED	PA-ED	PS-ED	PM-EM	TMD	IPP	STAY	PE-365	AOL	ACAB
DEP	5.79	10.83	14.93	0.80	4.24	-2.07	35.16	0.12	1.13	0.98
DECA	1	1	1	3	1	5	1	3	1	1



LEILÃO TABAPUÃ COPACABANA

R\$ **500,00**
x 30 parcelas
(2+2+2+2+2+2+18)
Valor por parcela

LOTE

07

A79 DA COPAC.

SEXO: **MACHO** - RAÇA: **TABAPUÃ PO** - REG: **GER A79** - NASC.: **25/01/2020**
PESO: **647 KG** - PE: **36 CM**

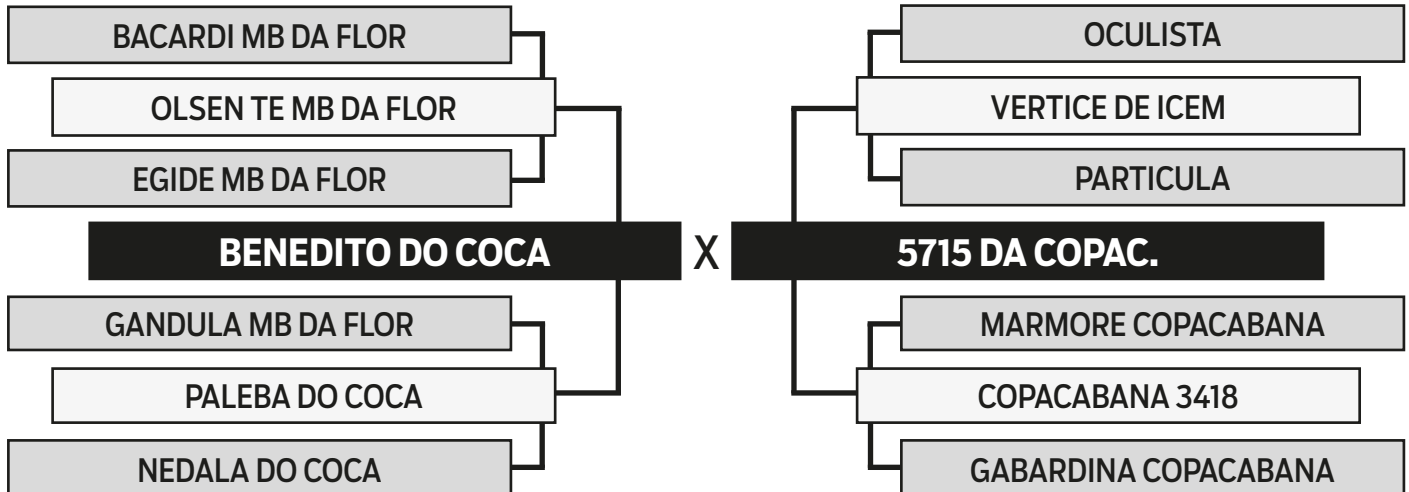

AVALIAÇÃO GENÉTICA - PMGZ



iABCZ: **8.54** - DECA: **2**

	PD-ED	PA-ED	PS-ED	PM-EM	TMD	IPP	STAY	PE-365	AOL	ACAB
DEP	1.87	4.42	5.62	1.54	3.26	-3.01	33.45	0.04	-0.30	-0.13
DECA	4	3	3	2	2	4	2	5	8	6



LEILÃO TABAPUÃ COPACABANA

R\$ **470,00**
x 30 parcelas
(2+2+2+2+2+2+18)
Valor por parcela

LOTE

08

A85 DA COPAC.

SEXO: **MACHO** - RAÇA: **TABAPUÃ PO** - REG: **GER A85** - NASC.: **25/01/2020**
PESO: **706 KG** - PE: **39 CM**

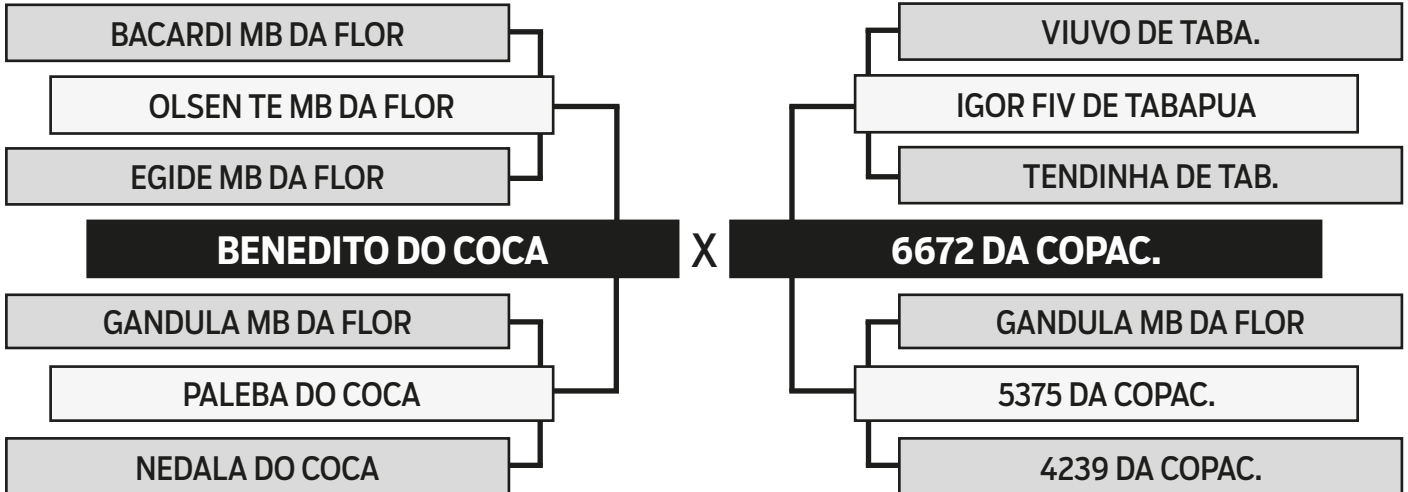

AVALIAÇÃO GENÉTICA - PMGZ



iABCZ: **11.26** - DECA: **1**

	PD-ED	PA-ED	PS-ED	PM-EM	TMD	IPP	STAY	PE-365	AOL	ACAB
DEP	3.20	6.36	8.61	1.92	4.36	-9.21	32.90	0.06	0.25	0.04
DECA	3	1	1	1	1	2	3	5	5	5



LEILÃO TABAPUÃ COPACABANA

R\$ **450,00**
x 30 parcelas
(2+2+2+2+2+2+18)
Valor por parcela

LOTE

09

A86 DA COPAC.

SEXO: **MACHO** - RAÇA: **TABAPUÃ PO** - REG: **GER A86** - NASC.: **25/01/2020**
PESO: **698 KG** - PE: **37 CM**

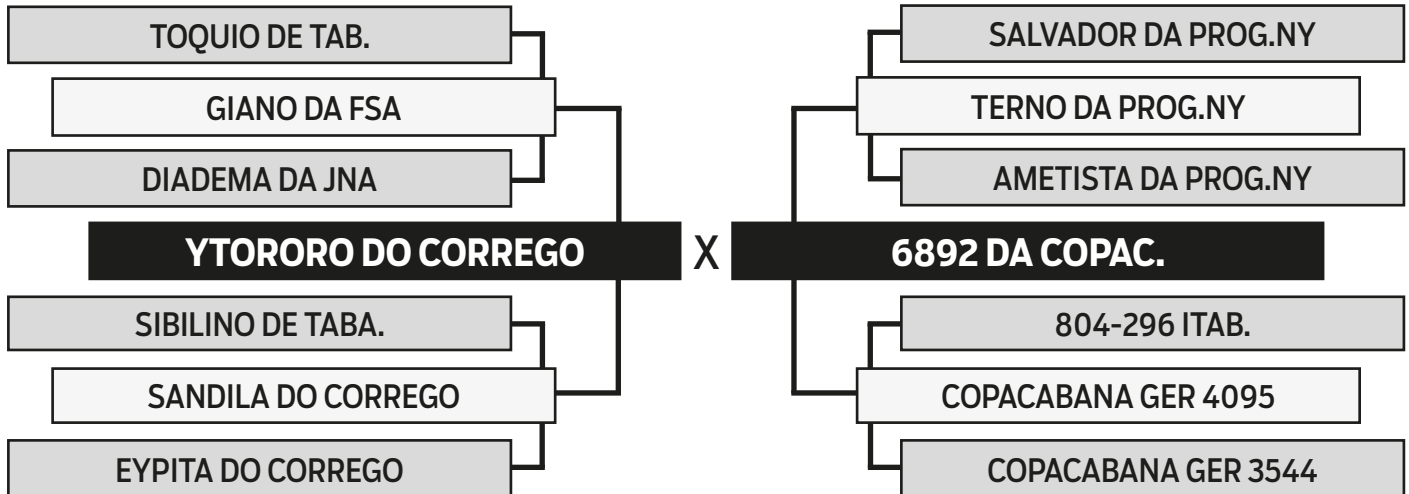

AVALIAÇÃO GENÉTICA - PMGZ



iABCZ: **8.60** - DECA: **2**

	PD-ED	PA-ED	PS-ED	PM-EM	TMD	IPP	STAY	PE-365	AOL	ACAB
DEP	5.95	6.18	9.37	0.06	3.30	-0.95	32.58	-0.19	1.02	1.72
DECA	1	2	1	6	2	5	4	9	1	1



LEILÃO TABAPUÃ COPACABANA

R\$ **450,00**
x 30 parcelas
(2+2+2+2+2+2+18)
Valor por parcela

LOTE

10

A99 DA COPAC.

SEXO: **MACHO** - RAÇA: **TABAPUÃ PO** - REG: **GER A99** - NASC.: **03/02/2020**
PESO: **630 KG** - PE: **38 CM**

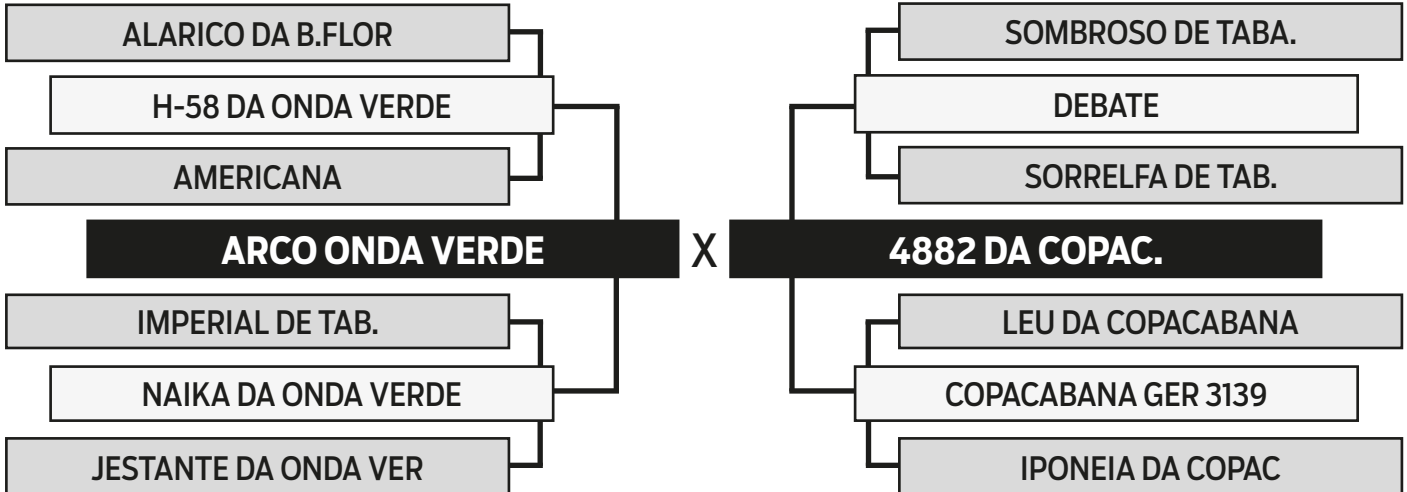

AVALIAÇÃO GENÉTICA - PMGZ



iABCZ: **7.23** - DECA: **3**

	PD-ED	PA-ED	PS-ED	PM-EM	TMD	IPP	STAY	PE-365	AOL	ACAB
DEP	3.10	3.77	2.70	2.41	3.90	-2.40	32.70	-0.01	1.36	0.52
DECA	3	3	5	1	1	5	3	6	1	3



LEILÃO TABAPUÃ COPACABANA

LOTE

11

A113 DA COPAC.

R\$ **470,00**
x 30 parcelas
(2+2+2+2+2+2+18)
Valor por parcela

SEXO: **MACHO** - RAÇA: **TABAPUÃ PO** - REG: **GER A113** - NASC.: **08/03/2020**
PESO: **700 KG** - PE: **38 CM**

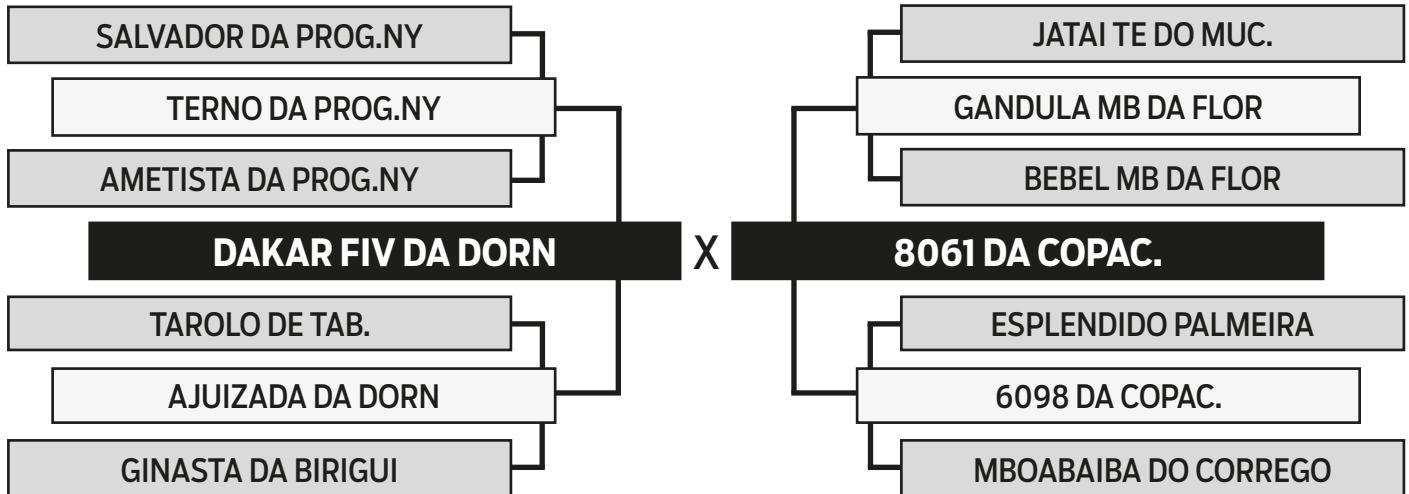

AVALIAÇÃO GENÉTICA - PMGZ



iABCZ: **15.72** - DECA: **1**

	PD-ED	PA-ED	PS-ED	PM-EM	TMD	IPP	STAY	PE-365	AOL	ACAB
DEP	5.78	9.22	10.61	1.02	4.76	-9.98	34.45	0.08	1.02	1.29
DECA	1	1	1	3	1	2	1	4	1	1



LEILÃO TABAPUÃ COPACABANA

R\$ **470,00**
x 30 parcelas
(2+2+2+2+2+2+18)
Valor por parcela

LOTE

12

A118 DA COPAC.

SEXO: **MACHO** - RAÇA: **TABAPUÃ PO** - REG: **GER A118** - NASC.: **13/03/2020**
PESO: **686 KG** - PE: **36 CM**

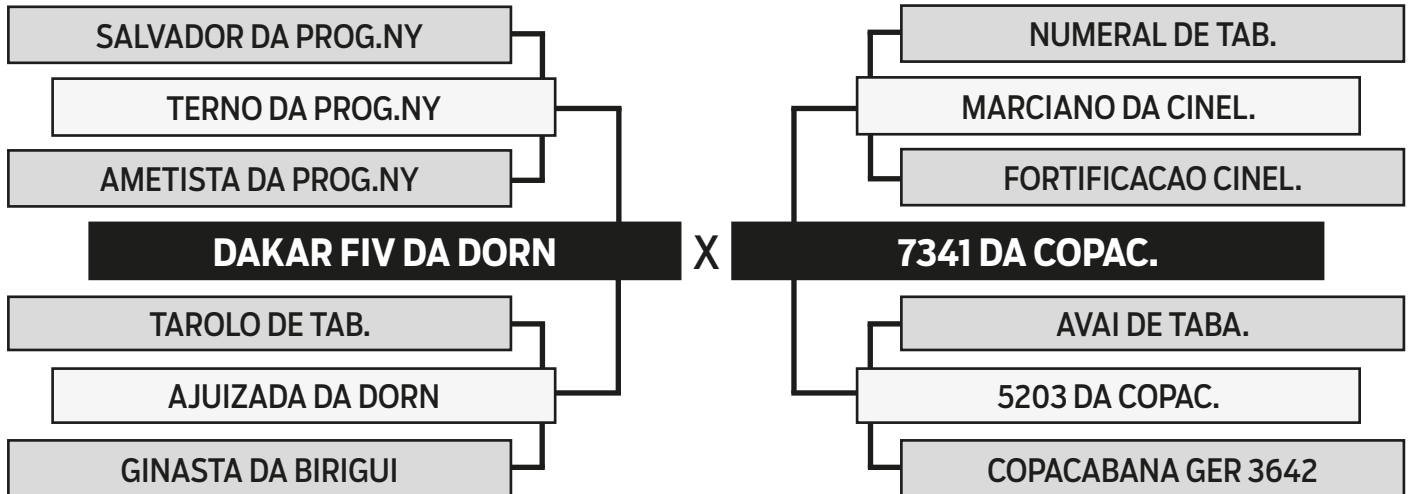

AVALIAÇÃO GENÉTICA - PMGZ



iABCZ: **10.28** - DECA: **2**

	PD-ED	PA-ED	PS-ED	PM-EM	TMD	IPP	STAY	PE-365	AOL	ACAB
DEP	4.50	6.89	6.67	0.79	3.92	-2.40	33.55	0.02	0.24	0.10
DECA	2	1	2	3	1	5	2	5	5	5



LEILÃO TABAPUÃ COPACABANA

LOTE

13

A125 DA COPAC.

R\$ **450,00**
x 30 parcelas
(2+2+2+2+2+2+18)
Valor por parcela

SEXO: **MACHO** - RAÇA: **TABAPUÃ PO** - REG: **GER A125** - NASC.: **15/03/2020**
PESO: **635 KG** - PE: **35 CM**

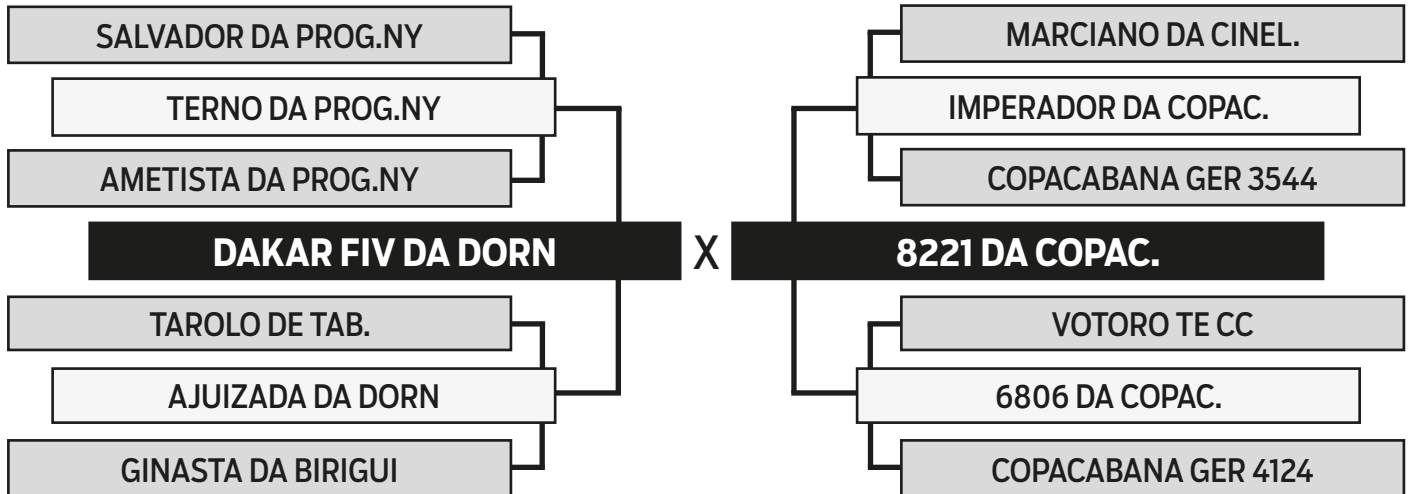

AVALIAÇÃO GENÉTICA - PMGZ



iABCZ: **10.73** - DECA: **1**

	PD-ED	PA-ED	PS-ED	PM-EM	TMD	IPP	STAY	PE-365	AOL	ACAB
DEP	4.43	6.56	9.42	0.05	2.82	-5.21	33.40	0.06	1.01	-0.07
DECA	2	1	1	6	2	3	2	5	1	6



LEILÃO TABAPUÃ COPACABANA

R\$ **500,00**
x 30 parcelas
(2+2+2+2+2+2+18)
Valor por parcela

LOTE

14

A127 DA COPAC.

SEXO: **MACHO** - RAÇA: **TABAPUÃ PO** - REG: **GER A127** - NASC.: **15/03/2020**
PESO: **640 KG** - PE: **33 CM**

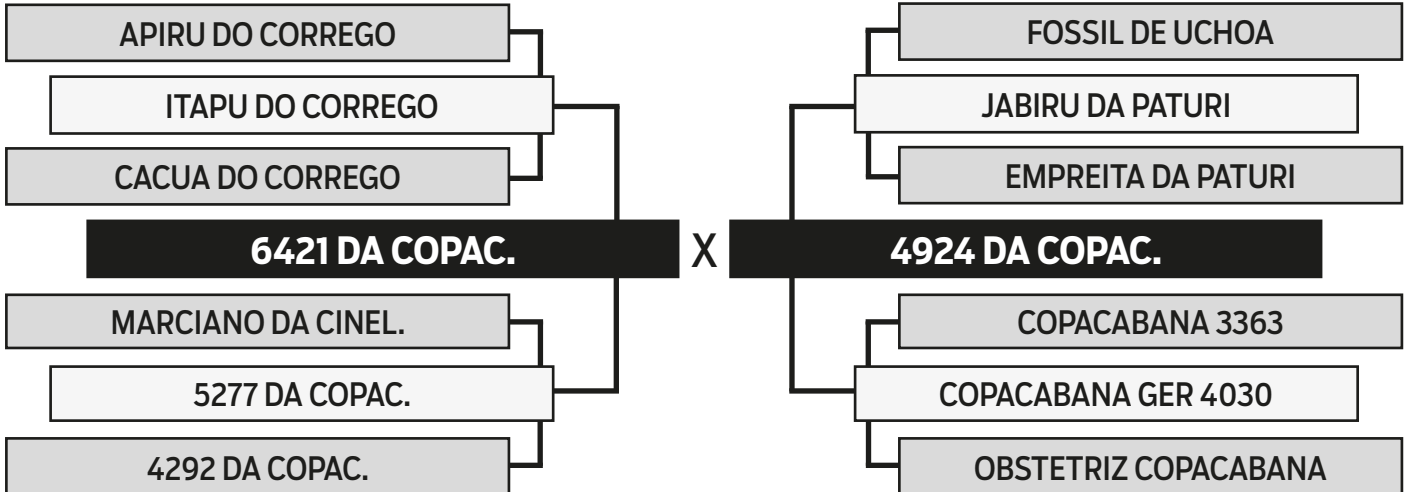

AVALIAÇÃO GENÉTICA - PMGZ



iABCZ: **16.04** - DECA: **1**

	PD-ED	PA-ED	PS-ED	PM-EM	TMD	IPP	STAY	PE-365	AOL	ACAB
DEP	8.00	11.01	11.58	0.86	5.65	-5.56	33.65	0.31	1.59	-0.16
DECA	1	1	1	3	1	3	2	1	1	6



LEILÃO TABAPUÃ COPACABANA

LOTE

15

A130 DA COPAC.

R\$ **450,00**
x 30 parcelas
(2+2+2+2+2+2+18)
Valor por parcela

SEXO: **MACHO** - RAÇA: **TABAPUÃ PO** - REG: **GER A130** - NASC.: **16/03/2020**
PESO: **596 KG** - PE: **36 CM**

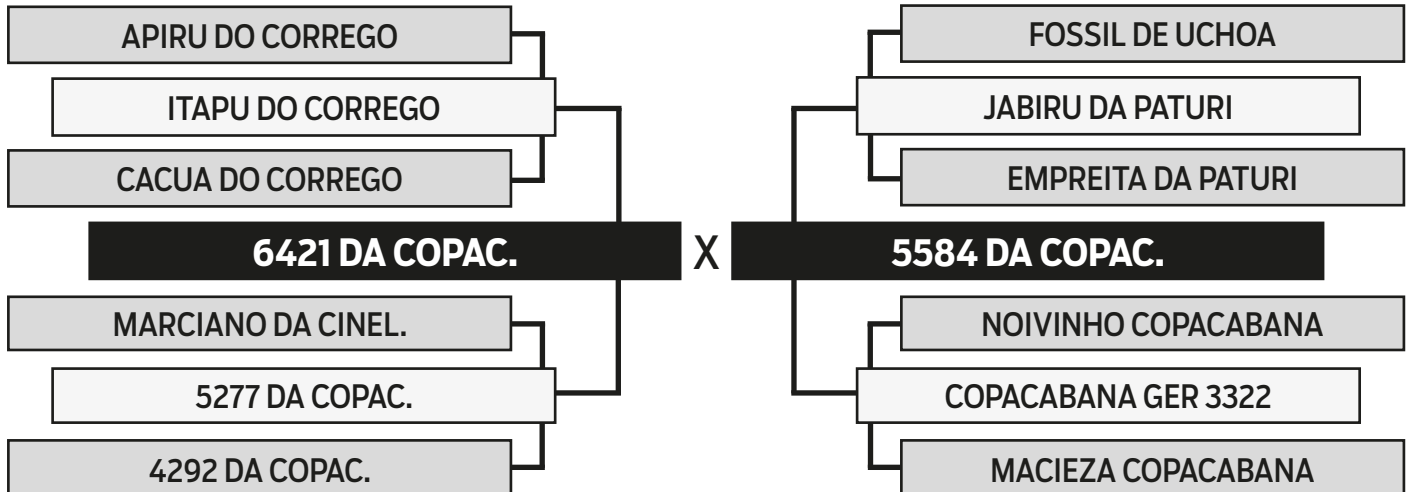

AVALIAÇÃO GENÉTICA - PMGZ



iABCZ: **15.89** - DECA: **1**

	PD-ED	PA-ED	PS-ED	PM-EM	TMD	IPP	STAY	PE-365	AOL	ACAB
DEP	8.05	9.37	7.87	0.75	5.21	-6.49	34.49	0.30	1.21	-0.18
DECA	1	1	2	3	1	3	1	1	1	6



LEILÃO TABAPUÃ COPACABANA

R\$ **470,00**
x 30 parcelas
(2+2+2+2+2+2+18)
Valor por parcela

LOTE

16

A131 DA COPAC.

SEXO: **MACHO** - RAÇA: **TABAPUÃ PO** - REG: **GER A131** - NASC.: **17/03/2020**
PESO: **724 KG** - PE: **36 CM**

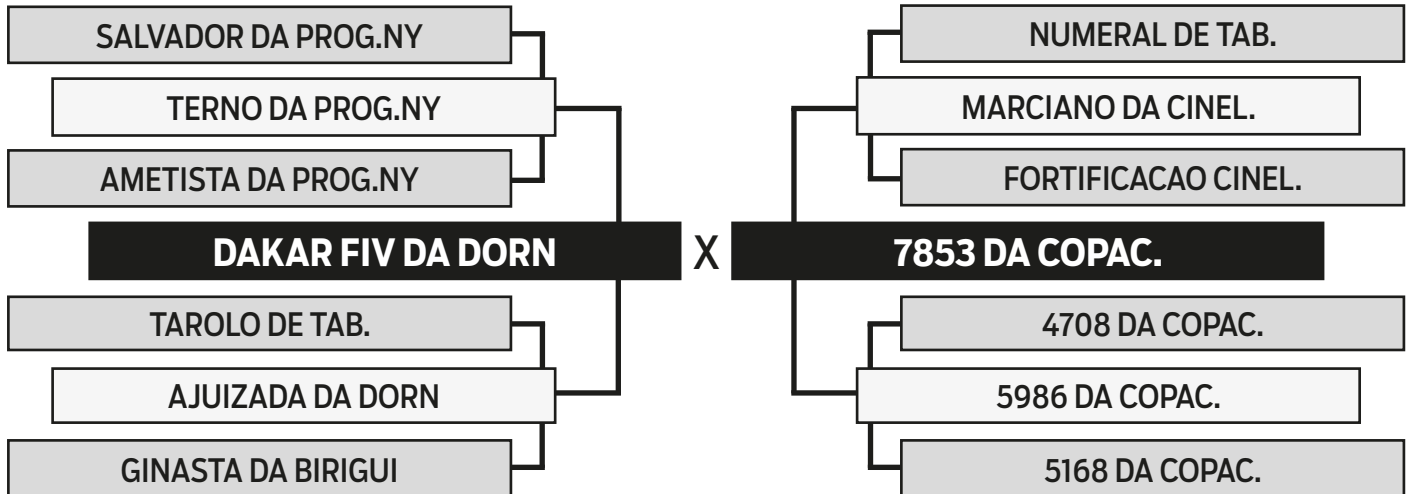

AVALIAÇÃO GENÉTICA - PMGZ



iABCZ: **10.21** - DECA: **2**

	PD-ED	PA-ED	PS-ED	PM-EM	TMD	IPP	STAY	PE-365	AOL	ACAB
DEP	4.62	6.90	7.56	0.77	3.71	-11.72	32.17	0.02	0.61	0.01
DECA	2	1	2	3	2	1	4	6	3	5



LEILÃO TABAPUÃ COPACABANA

R\$ **470,00**
x 30 parcelas
(2+2+2+2+2+2+18)
Valor por parcela

LOTE

17

A138 DA COPAC.

SEXO: **MACHO** - RAÇA: **TABAPUÃ PO** - REG: **GER A138** - NASC.: **20/03/2020**
PESO: **640 KG** - PE: **38 CM**

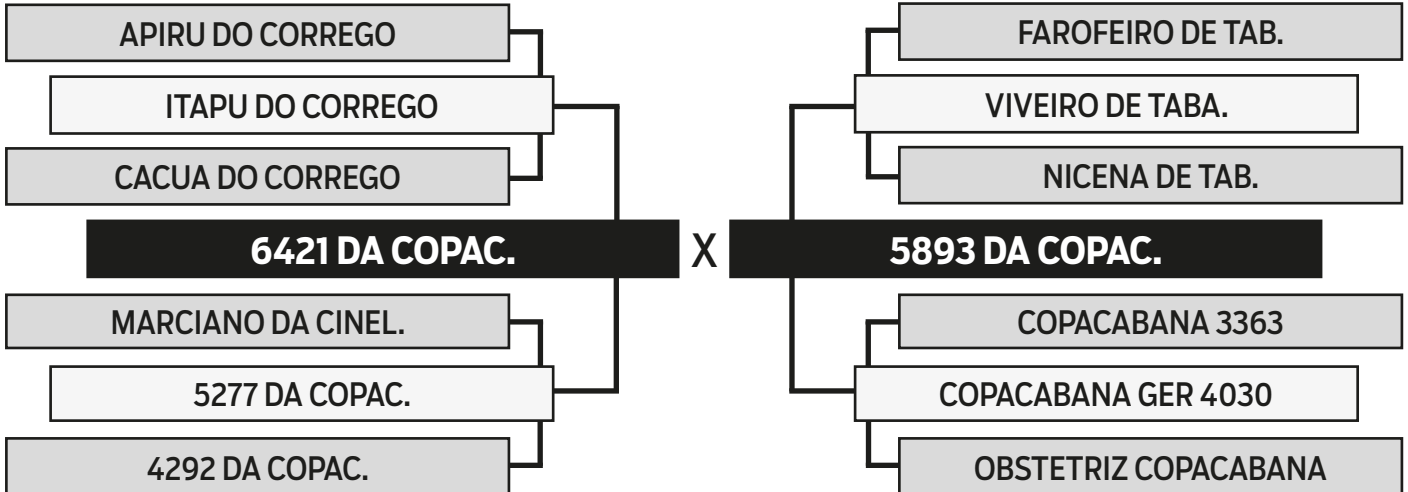

AVALIAÇÃO GENÉTICA - PMGZ



iABCZ: **15.20** - DECA: **1**

	PD-ED	PA-ED	PS-ED	PM-EM	TMD	IPP	STAY	PE-365	AOL	ACAB
DEP	7.80	10.61	12.83	0.22	4.39	-5.14	33.75	0.15	2.55	0.04
DECA	1	1	1	5	1	3	2	3	1	5



LEILÃO TABAPUÃ COPACABANA

R\$ **450,00**
x 30 parcelas
(2+2+2+2+2+2+18)
Valor por parcela

LOTE

18

A140 DA COPAC.

SEXO: **MACHO** - RAÇA: **TABAPUÃ PO** - REG: **GER A140** - NASC.: **22/03/2020**
PESO: **744 KG** - PE: **40 CM**

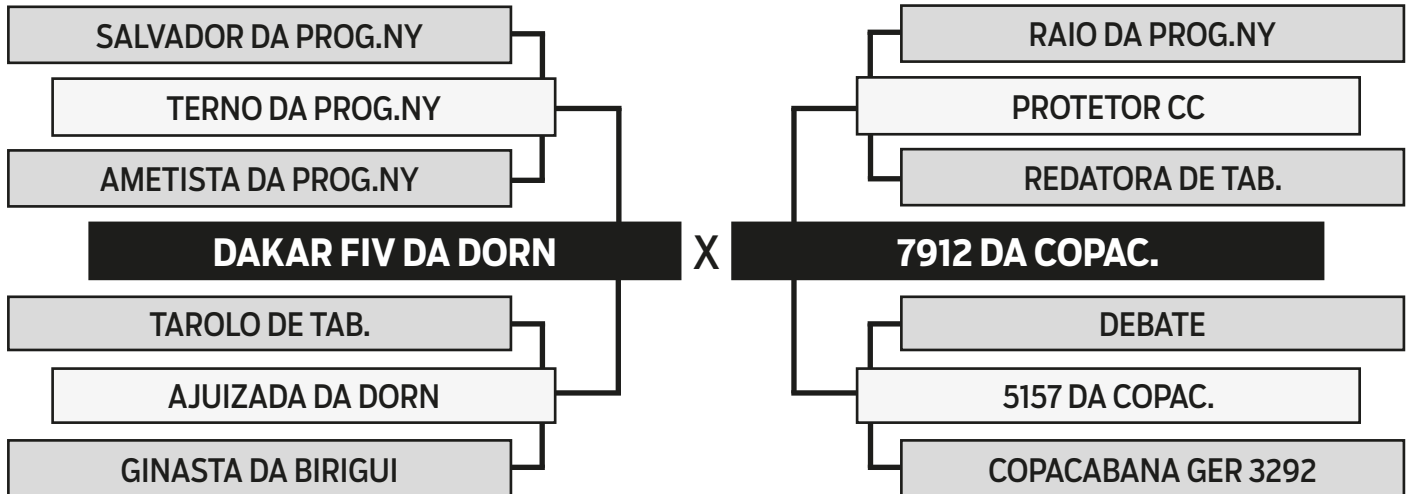

AVALIAÇÃO GENÉTICA - PMGZ



iABCZ: **9.44** - DECA: **2**

	PD-ED	PA-ED	PS-ED	PM-EM	TMD	IPP	STAY	PE-365	AOL	ACAB
DEP	4.70	5.40	5.65	0.88	3.08	-14.01	32.23	-0.09	0.03	0.40
DECA	2	2	3	3	2	1	4	8	6	3



LEILÃO TABAPUÃ COPACABANA

LOTE

19

A141 DA COPAC.

R\$ **470,00**
x 30 parcelas
(2+2+2+2+2+2+18)
Valor por parcela

SEXO: **MACHO** - RAÇA: **TABAPUÃ PO** - REG: **GER A141** - NASC.: **22/03/2020**
PESO: **664 KG** - PE: **41 CM**

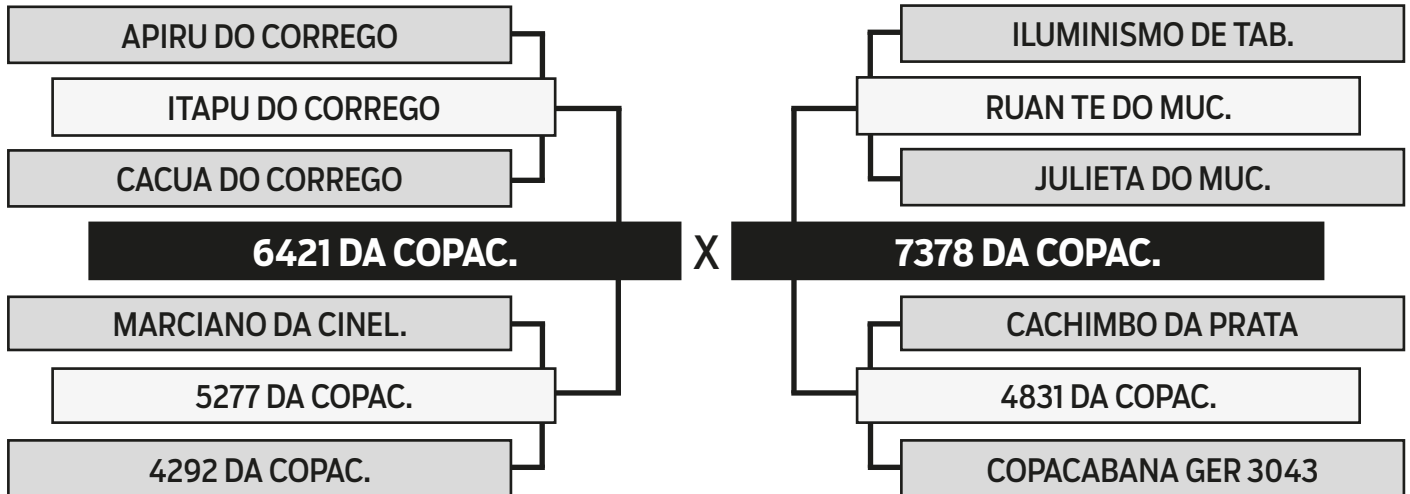

AVALIAÇÃO GENÉTICA - PMGZ



iABCZ: **12.92** - DECA: **1**

	PD-ED	PA-ED	PS-ED	PM-EM	TMD	IPP	STAY	PE-365	AOL	ACAB
DEP	7.42	9.04	10.07	1.11	4.76	1.84	33.84	0.05	1.87	-0.04
DECA	1	1	1	3	1	7	2	5	1	6



LEILÃO TABAPUÃ COPACABANA

R\$ **470,00**
x 30 parcelas
(2+2+2+2+2+2+18)
Valor por parcela

LOTE

20

A148 DA COPAC.

SEXO: **MACHO** - RAÇA: **TABAPUÃ PO** - REG: **GER A148** - NASC.: **18/04/2020**
PESO: **635 KG** - PE: **42 CM**

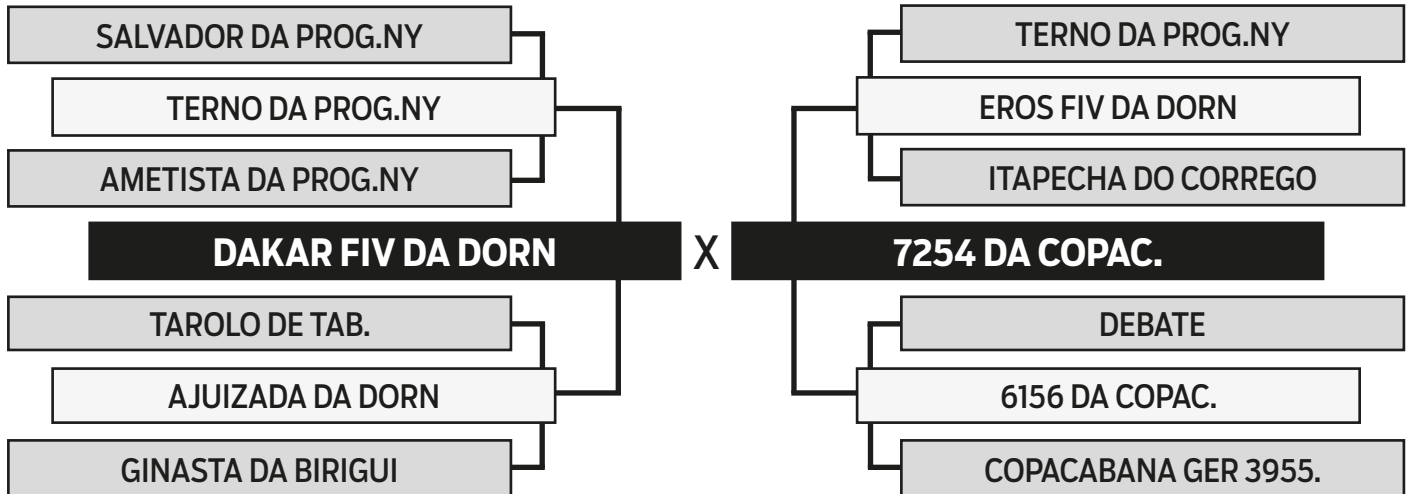

AVALIAÇÃO GENÉTICA - PMGZ



iABCZ: **14.00** - DECA: **1**

	PD-ED	PA-ED	PS-ED	PM-EM	TMD	IPP	STAY	PE-365	AOL	ACAB
DEP	6.48	7.64	8.56	0.48	4.11	-11.37	34.19	-0.10	1.01	0.90
DECA	1	1	1	4	1	1	2	8	1	2



LEILÃO TABAPUÃ COPACABANA

LOTE

21

A159 DA COPAC.

R\$ **400,00**
x 30 parcelas
(2+2+2+2+2+2+18)
Valor por parcela

SEXO: **MACHO** - RAÇA: **TABAPUÃ PO** - REG: **GER A159** - NASC.: **27/09/2020**
PESO: **597 KG** - PE: **36 CM**

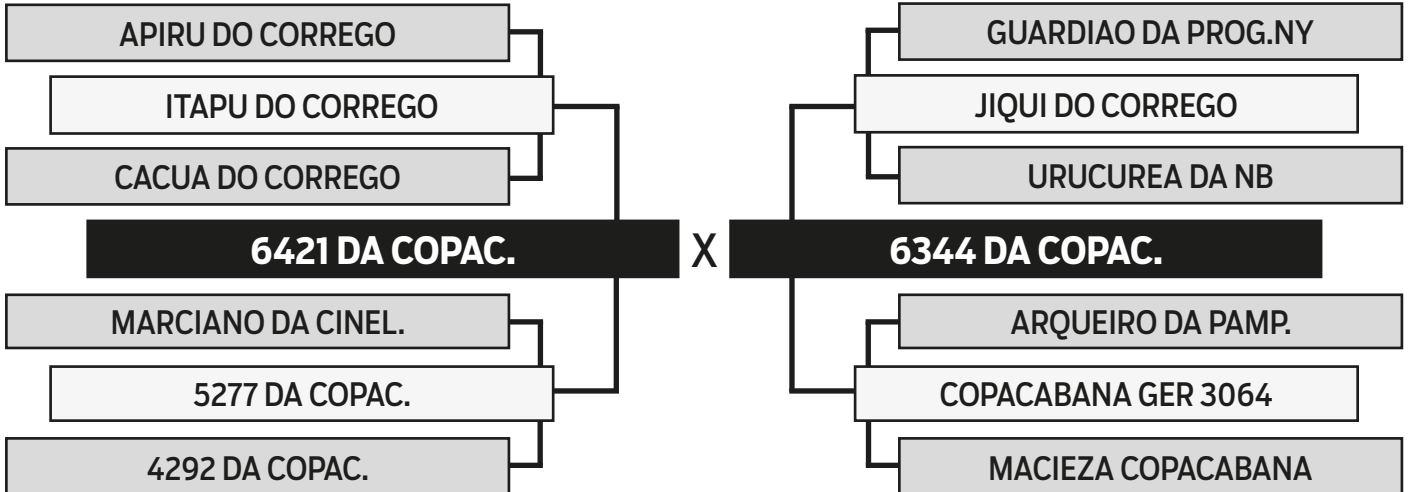

AVALIAÇÃO GENÉTICA - PMGZ



iABCZ: **15.89** - DECA: **1**

	PD-ED	PA-ED	PS-ED	PM-EM	TMD	IPP	STAY	PE-365	AOL	ACAB
DEP	7.26	9.85	11.44	0.38	4.01	-4.89	34.99	0.05	1.63	0.47
DECA	1	1	1	5	1	3	1	5	1	3



LEILÃO TABAPUÃ COPACABANA

LOTE

22

A163 DA COPAC.

R\$ **400,00**
x 30 parcelas
(2+2+2+2+2+2+18)
Valor por parcela

SEXO: **MACHO** - RAÇA: **TABAPUÃ PO** - REG: **GER A163** - NASC.: **27/09/2020**
PESO: **542 KG** - PE: **35 CM**

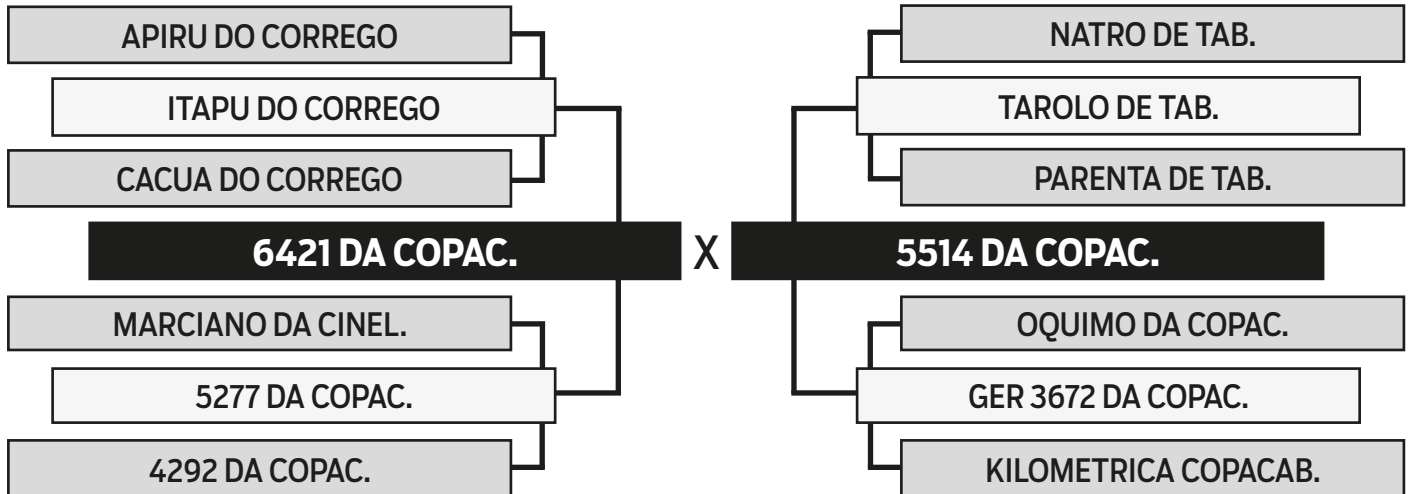

AVALIAÇÃO GENÉTICA - PMGZ



iABCZ: **17.37** - DECA: **1**

	PD-ED	PA-ED	PS-ED	PM-EM	TMD	IPP	STAY	PE-365	AOL	ACAB
DEP	9.70	12.91	12.61	1.72	7.23	-3.33	33.57	0.18	2.35	-0.03
DECA	1	1	1	1	1	4	2	2	1	6



LEILÃO TABAPUÃ COPACABANA

R\$ **470,00**
x 30 parcelas
(2+2+2+2+2+2+18)
Valor por parcela

LOTE

23

A167 DA COPAC.

SEXO: **MACHO** - RAÇA: **TABAPUÃ PO** - REG: **GER A167** - NASC.: **29/09/2020**
PESO: **530 KG** - PE: **35 CM**

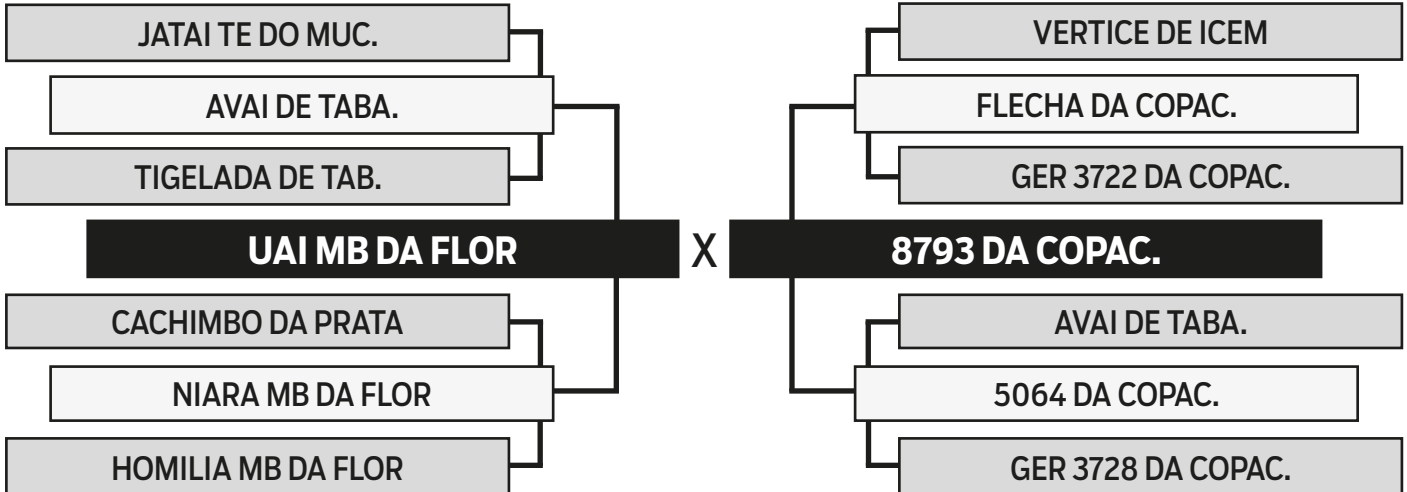

AVALIAÇÃO GENÉTICA - PMGZ



iABCZ: **15.54** - DECA: **1**

	PD-ED	PA-ED	PS-ED	PM-EM	TMD	IPP	STAY	PE-365	AOL	ACAB
DEP	6.13	10.78	14.66	3.84	8.26	4.24	32.67	0.55	1.57	-0.30
DECA	1	1	1	1	1	8	4	1	1	7



LEILÃO TABAPUÃ COPACABANA

R\$ **450,00**
x 30 parcelas
(2+2+2+2+2+2+18)
Valor por parcela

LOTE

24

A173 DA COPAC.

SEXO: **MACHO** - RAÇA: **TABAPUÃ PO** - REG: **GER A173** - NASC.: **02/10/2020**
PESO: **522 KG** - PE: **36 CM**

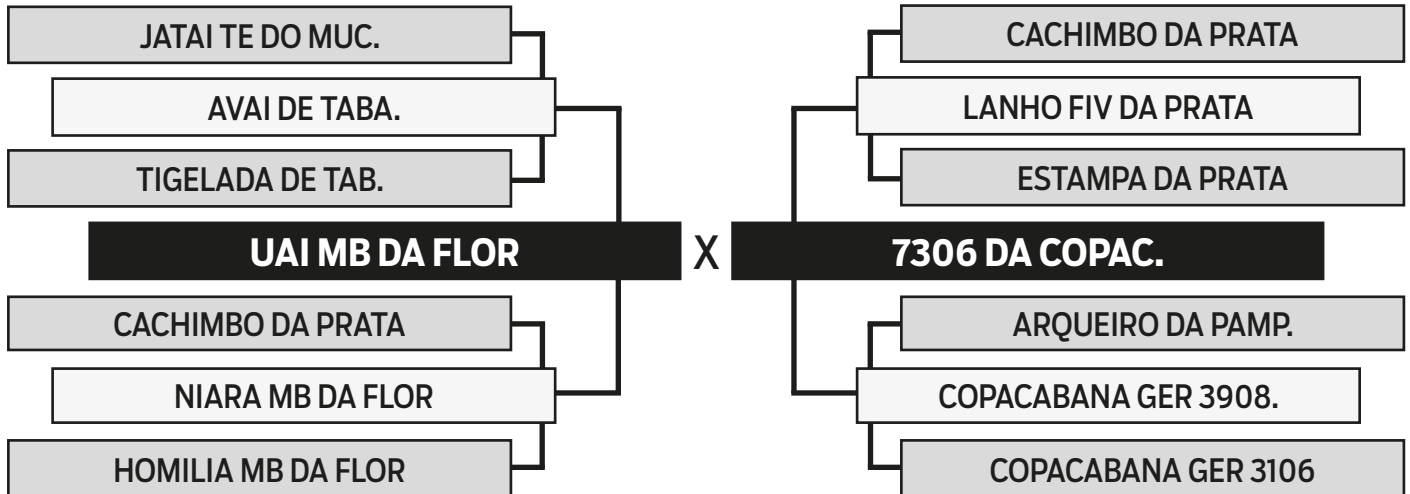

AVALIAÇÃO GENÉTICA - PMGZ



iABCZ: **8.06** - DECA: **2**

	PD-ED	PA-ED	PS-ED	PM-EM	TMD	IPP	STAY	PE-365	AOL	ACAB
DEP	2.47	5.08	10.52	2.63	4.63	6.77	32.05	0.34	1.42	-0.28
DECA	4	2	1	1	1	9	5	1	1	7



LEILÃO TABAPUÃ COPACABANA

R\$ **470,00**
x 30 parcelas
(2+2+2+2+2+2+18)
Valor por parcela

LOTE

25

A179 DA COPAC.

SEXO: **MACHO** - RAÇA: **TABAPUÃ PO** - REG: **GER A179** - NASC.: **03/10/2020**
PESO: **572 KG** - PE: **36 CM**

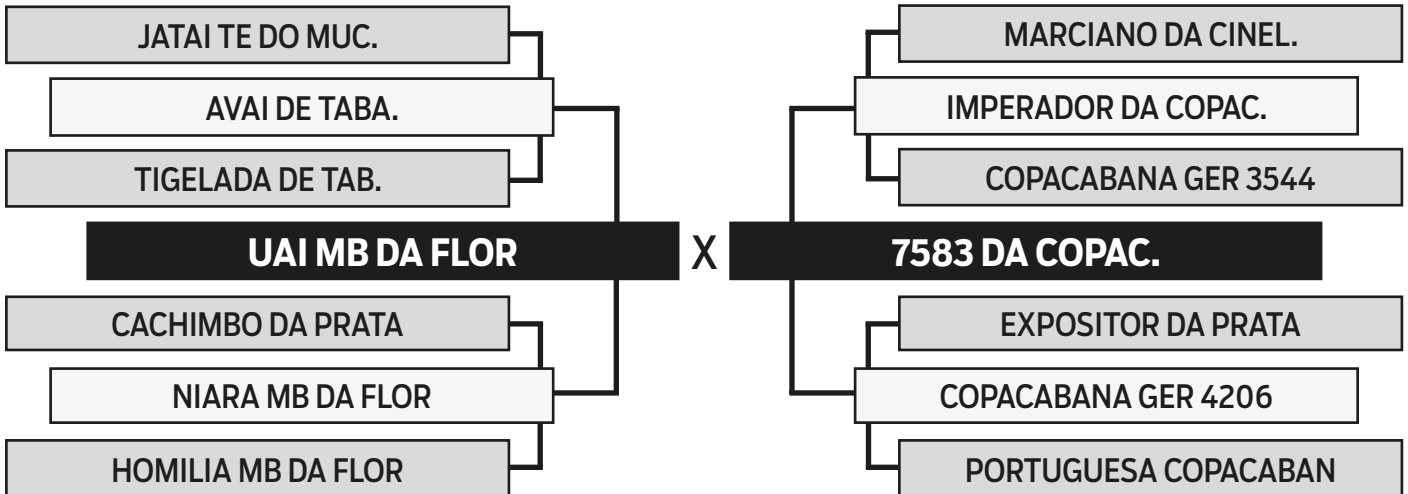

AVALIAÇÃO GENÉTICA - PMGZ



iABCZ: **9.78** - DECA: **2**

	PD-ED	PA-ED	PS-ED	PM-EM	TMD	IPP	STAY	PE-365	AOL	ACAB
DEP	5.37	5.80	10.40	2.28	5.79	4.54	31.74	0.46	1.88	-0.73
DECA	1	2	1	1	1	8	5	1	1	9



LEILÃO TABAPUÃ COPACABANA

R\$ **450,00**
x 30 parcelas
(2+2+2+2+2+2+18)
Valor por parcela

LOTE

26

A190 DA COPAC.

SEXO: **MACHO** - RAÇA: **TABAPUÃ PO** - REG: **GER A190** - NASC.: **04/10/2020**
PESO: **538 KG** - PE: **34 CM**

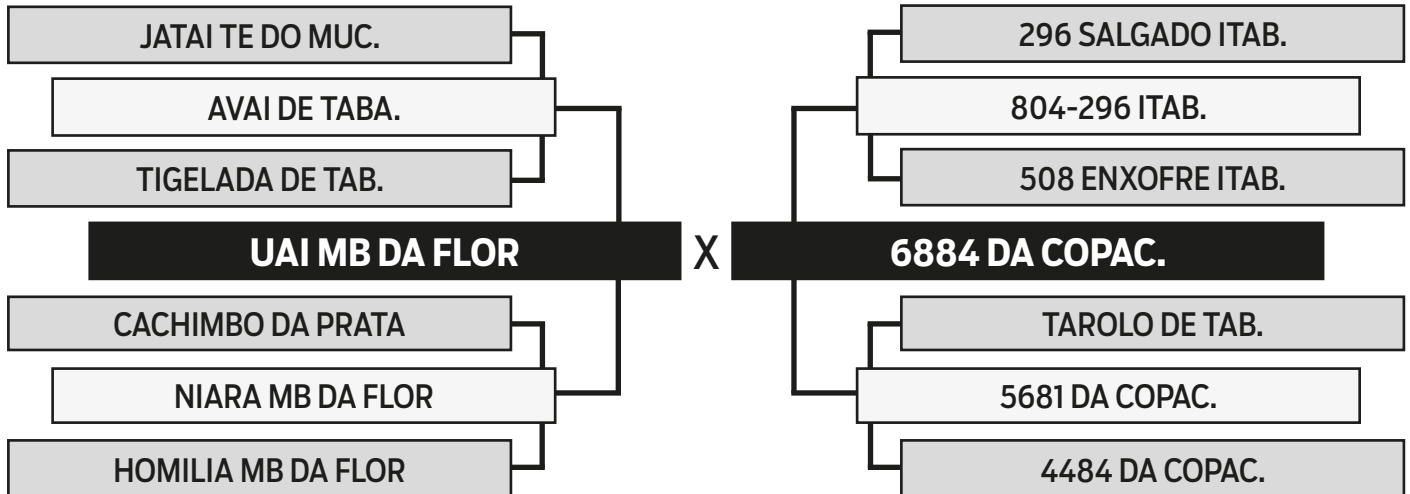

AVALIAÇÃO GENÉTICA - PMGZ



iABCZ: **4.33** - DECA: **4**

	PD-ED	PA-ED	PS-ED	PM-EM	TMD	IPP	STAY	PE-365	AOL	ACAB
DEP	4.18	4.35	5.16	2.69	5.64	11.44	30.41	0.45	1.61	-0.06
DECA	2	3	3	1	1	10	8	1	1	6



LEILÃO TABAPUÃ COPACABANA

R\$ **450,00**
x 30 parcelas
(2+2+2+2+2+2+18)
Valor por parcela

LOTE

27

A229 DA COPAC.

SEXO: **MACHO** - RAÇA: **TABAPUÃ PO** - REG: **GER A229** - NASC.: **03/11/2020**
PESO: **487 KG** - PE: **35 CM**

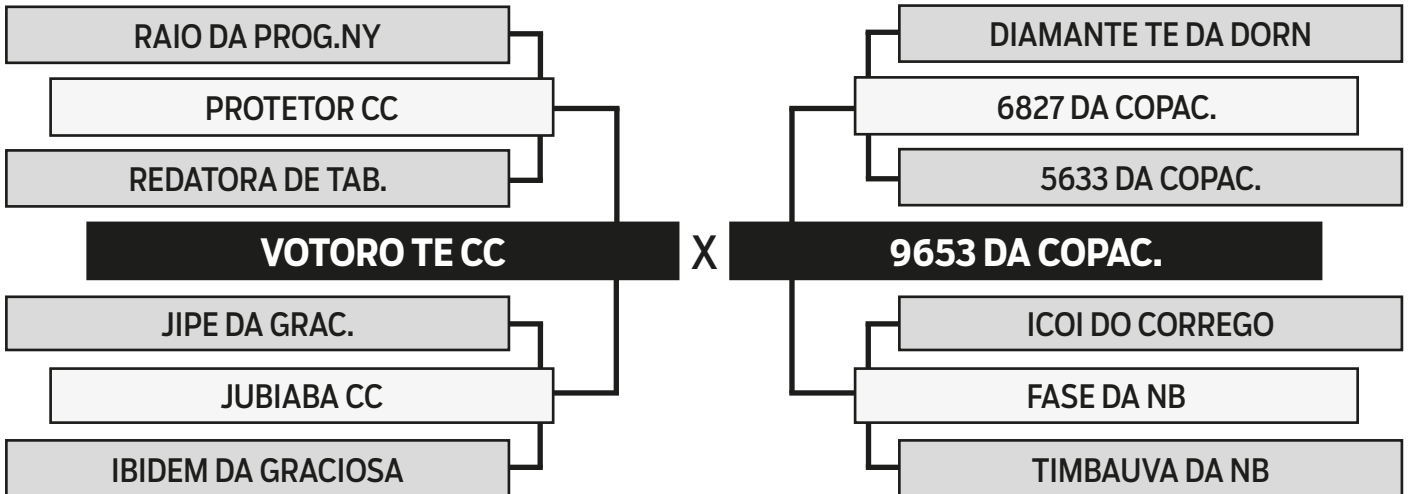

AVALIAÇÃO GENÉTICA - PMGZ



iABCZ: **7.03** - DECA: **3**

	PD-ED	PA-ED	PS-ED	PM-EM	TMD	IPP	STAY	PE-365	AOL	ACAB
DEP	4.79	6.74	7.94	0.75	3.28	-6.20	30.53	0.14	0.40	-0.20
DECA	1	1	1	3	2	3	7	3	4	7



LEILÃO TABAPUÃ COPACABANA

R\$ **450,00**
x 30 parcelas
(2+2+2+2+2+2+18)
Valor por parcela

LOTE

28

A233 DA COPAC.

SEXO: **MACHO** - RAÇA: **TABAPUÃ PO** - REG: **GER A233** - NASC.: **03/11/2020**
PESO: **447 KG** - PE: **34 CM**

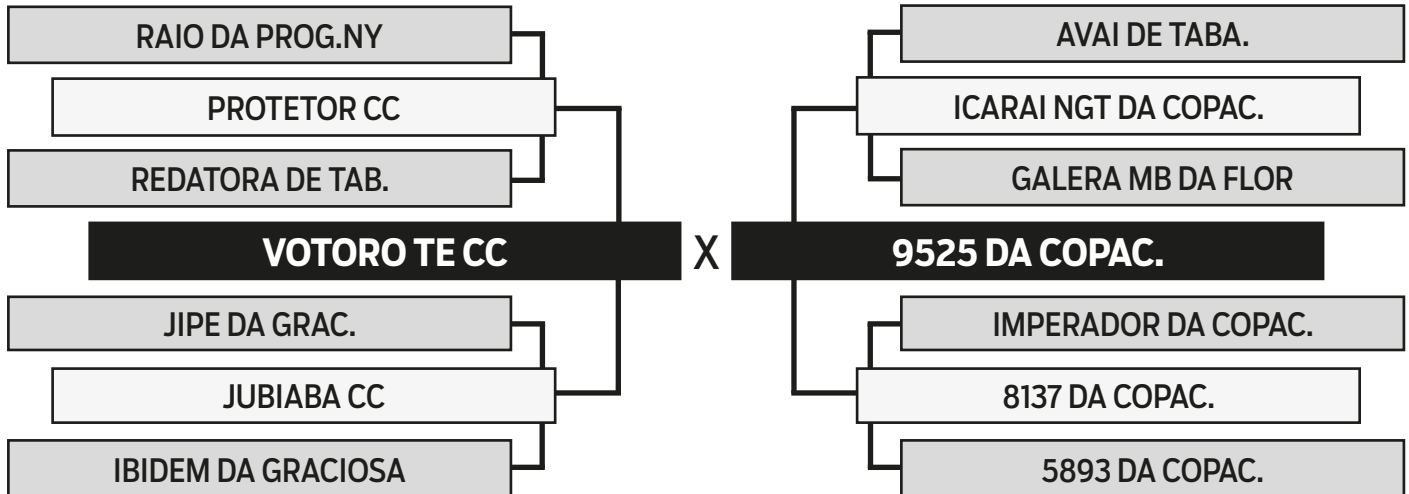

AVALIAÇÃO GENÉTICA - PMGZ



iABCZ: **0.19** - DECA: **6**

	PD-ED	PA-ED	PS-ED	PM-EM	TMD	IPP	STAY	PE-365	AOL	ACAB
DEP	1.06	2.04	3.16	-0.39	0.08	2.42	30.84	0.01	0.66	-0.45
DECA	5	5	4	7	6	7	7	6	3	8



LEILÃO TABAPUÃ COPACABANA

R\$ **450,00**
x 30 parcelas
(2+2+2+2+2+2+18)
Valor por parcela

LOTE

29

A248 DA COPAC.

SEXO: **MACHO** - RAÇA: **TABAPUÃ PO** - REG: **GER A248** - NASC.: **06/11/2020**
PESO: **480 KG** - PE: **37 CM**

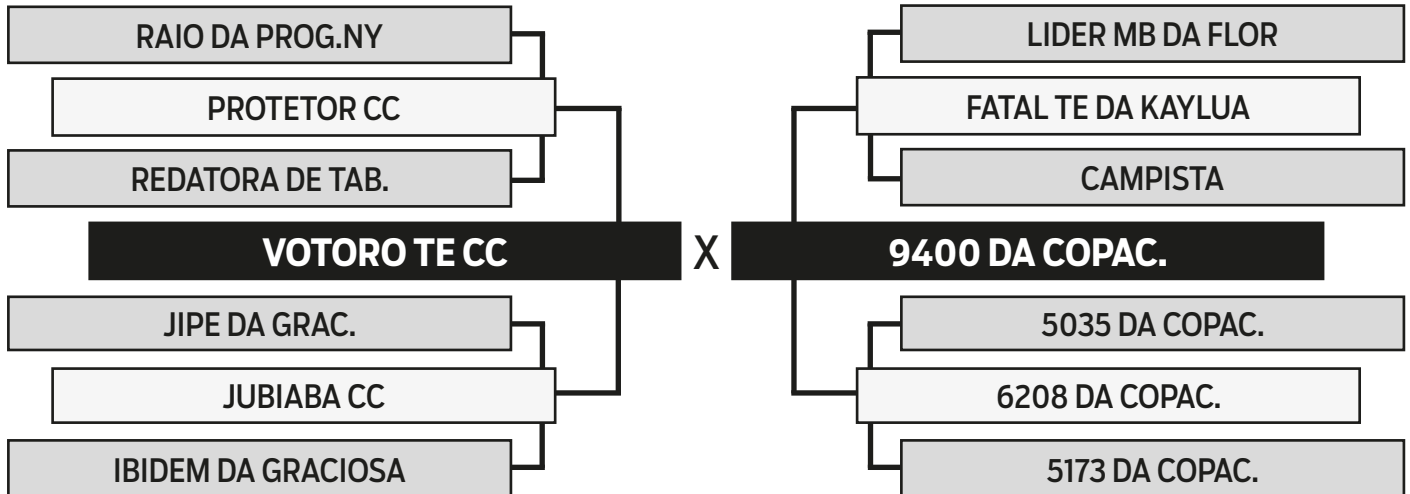

AVALIAÇÃO GENÉTICA - PMGZ



iABCZ: **0.58** - DECA: **6**

	PD-ED	PA-ED	PS-ED	PM-EM	TMD	IPP	STAY	PE-365	AOL	ACAB
DEP	3.24	4.20	4.27	-0.51	0.69	-3.01	29.14	0.06	0.29	0.31
DECA	3	3	3	8	5	4	9	5	4	4



LEILÃO TABAPUÃ COPACABANA

R\$ **400,00**
x 30 parcelas
(2+2+2+2+2+2+18)
Valor por parcela

LOTE

30

A252 DA COPAC.

SEXO: **MACHO** - RAÇA: **TABAPUÃ PO** - REG: **GER A252** - NASC.: **06/11/2020**
PESO: **530 KG** - PE: **44 CM**

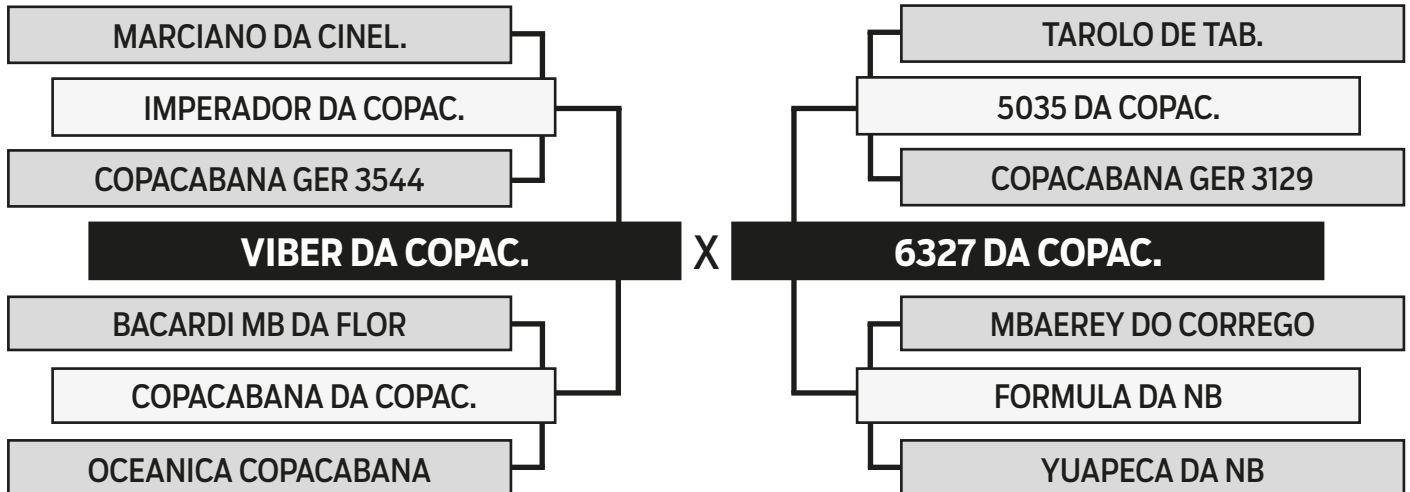

AVALIAÇÃO GENÉTICA - PMGZ



iABCZ: **12.36** - DECA: **1**

	PD-ED	PA-ED	PS-ED	PM-EM	TMD	IPP	STAY	PE-365	AOL	ACAB
DEP	4.71	7.51	10.12	1.34	4.60	-6.04	32.45	0.53	1.77	-0.51
DECA	2	1	1	2	1	3	4	1	1	8



LEILÃO TABAPUÃ COPACABANA

R\$ **400,00**
x 30 parcelas
(2+2+2+2+2+2+18)
Valor por parcela

LOTE

31

A253 DA COPAC.

SEXO: **MACHO** - RAÇA: **TABAPUÃ PO** - REG: **GER A253** - NASC.: **06/11/2020**
PESO: **448 KG** - PE: **34 CM**

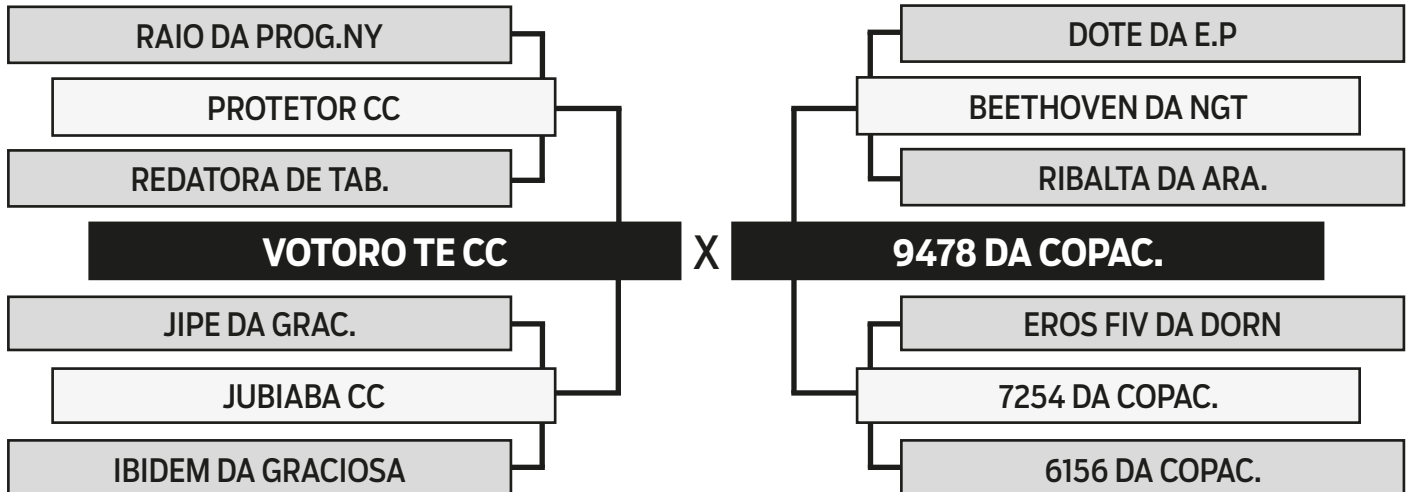

AVALIAÇÃO GENÉTICA - PMGZ



iABCZ: **7.01** - DECA: **3**

	PD-ED	PA-ED	PS-ED	PM-EM	TMD	IPP	STAY	PE-365	AOL	ACAB
DEP	5.70	5.04	5.76	-1.16	0.86	-4.53	32.72	-0.14	1.15	0.26
DECA	1	2	2	9	5	4	3	9	1	4



LEILÃO TABAPUÃ COPACABANA

R\$ **400,00**
x 30 parcelas
(2+2+2+2+2+2+18)
Valor por parcela

LOTE

32

A265 DA COPAC.

SEXO: **MACHO** - RAÇA: **TABAPUÃ PO** - REG: **GER A265** - NASC.: **10/11/2020**
PESO: **525 KG** - PE: **38 CM**

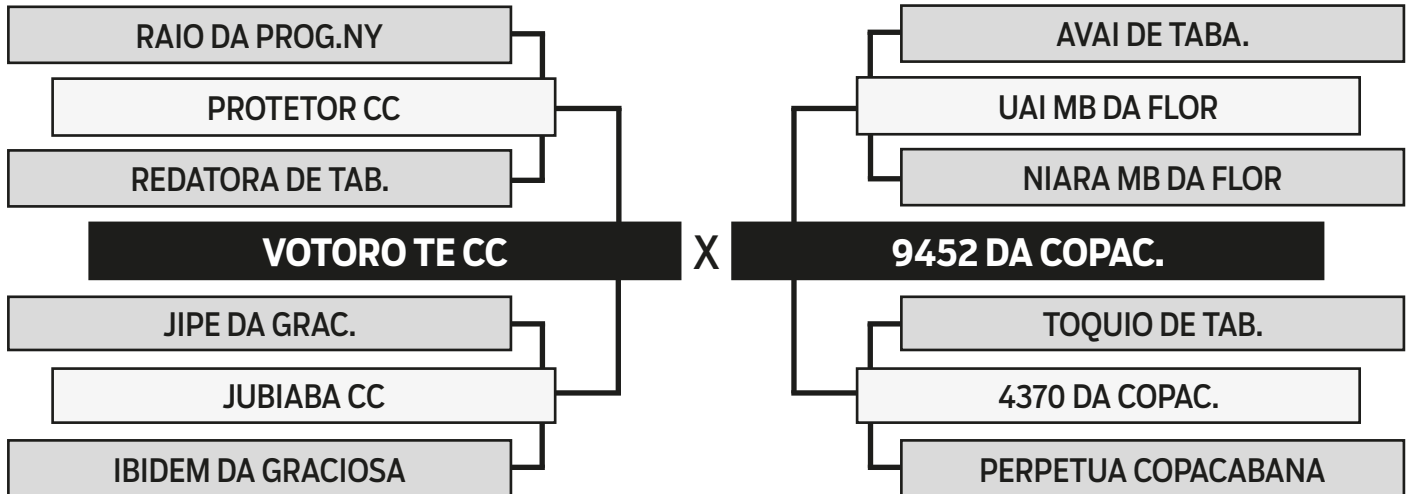

AVALIAÇÃO GENÉTICA - PMGZ



iABCZ: **1.38** - DECA: **6**

	PD-ED	PA-ED	PS-ED	PM-EM	TMD	IPP	STAY	PE-365	AOL	ACAB
DEP	4.18	4.38	5.72	1.03	3.44	2.01	28.65	0.13	0.51	-0.36
DECA	2	3	2	3	2	7	10	3	3	7



LEILÃO TABAPUÃ COPACABANA

R\$ **400,00**
x 30 parcelas
(2+2+2+2+2+2+18)
Valor por parcela

LOTE

33

A280 DA COPAC.

SEXO: **MACHO** - RAÇA: **TABAPUÃ PO** - REG: **GER A280** - NASC.: **15/11/2020**
PESO: **491 KG** - PE: **35 CM**

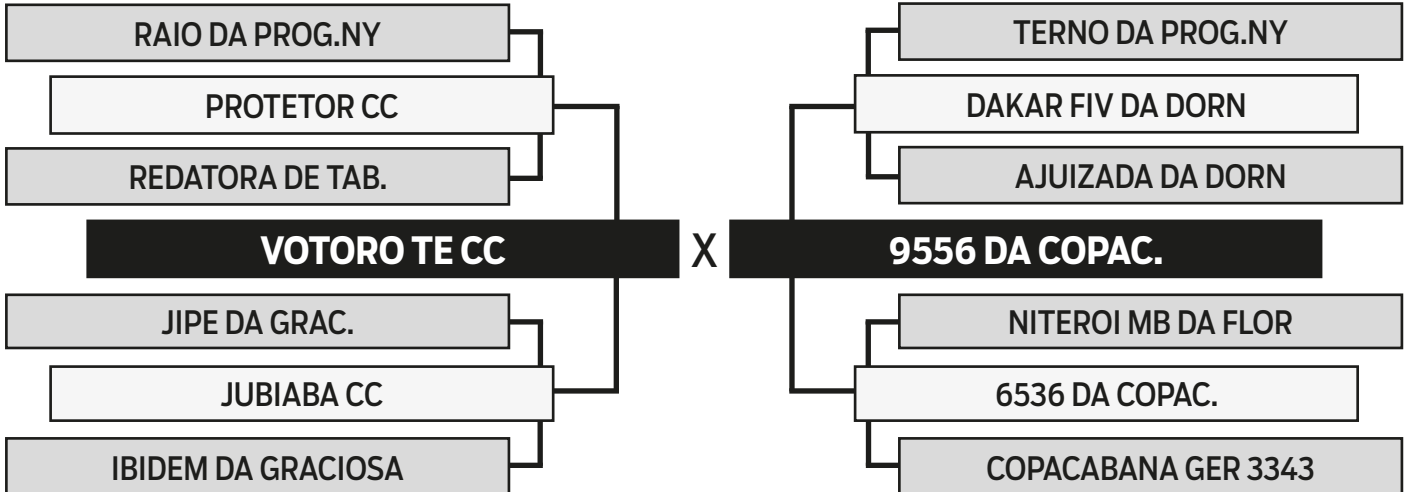

AVALIAÇÃO GENÉTICA - PMGZ



iABCZ: **1.27** - DECA: **6**

	PD-ED	PA-ED	PS-ED	PM-EM	TMD	IPP	STAY	PE-365	AOL	ACAB
DEP	1.08	2.44	2.39	-0.48	-0.04	-2.87	31.12	-0.05	-0.06	0.10
DECA	5	4	5	7	7	4	6	7	7	5



LEILÃO TABAPUÃ COPACABANA

LOTE

34

A298 DA COPAC.

R\$ **400,00**
x 30 parcelas
(2+2+2+2+2+2+18)
Valor por parcela

SEXO: **MACHO** - RAÇA: **TABAPUÃ PO** - REG: **GER A298** - NASC.: **18/12/2020**
PESO: **480 KG** - PE: **42 CM**

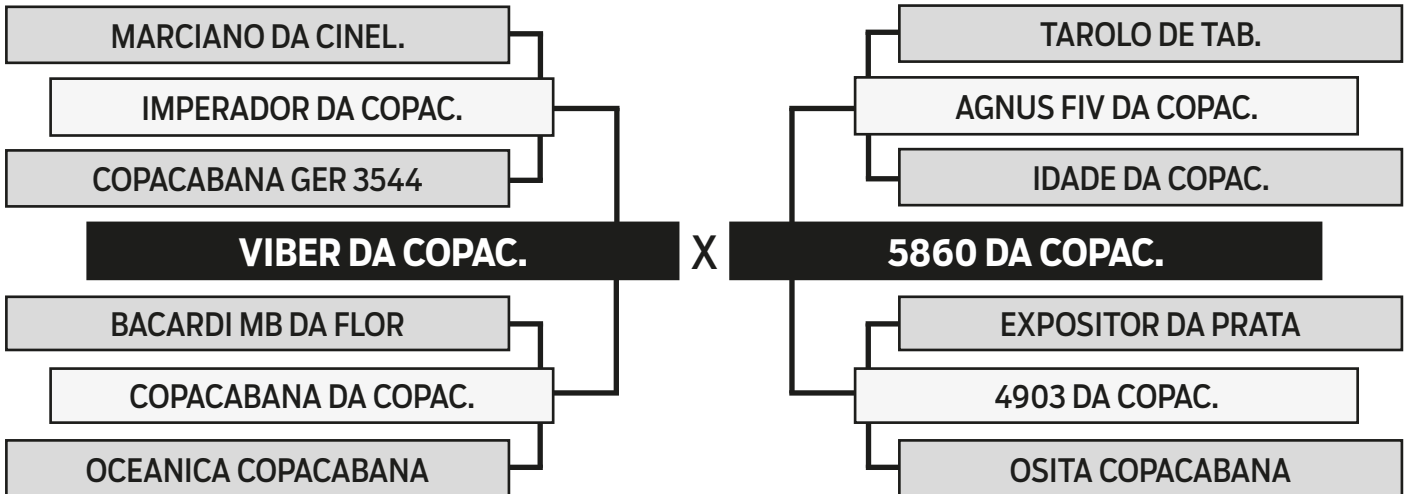

AVALIAÇÃO GENÉTICA - PMGZ



iABCZ: **15.30** - DECA: **1**

	PD-ED	PA-ED	PS-ED	PM-EM	TMD	IPP	STAY	PE-365	AOL	ACAB
DEP	6.90	8.87	10.48	1.43	5.65	-4.98	33.44	0.55	1.46	-0.54
DECA	1	1	1	2	1	3	2	1	1	8



LEILÃO TABAPUÃ COPACABANA

R\$ **400,00**
x 30 parcelas
(2+2+2+2+2+2+18)
Valor por parcela

LOTE

35

A315 DA COPAC.

SEXO: **MACHO** - RAÇA: **TABAPUÃ PO** - REG: **GER A315** - NASC.: **25/12/2020**
PESO: **495 KG** - PE: **36 CM**

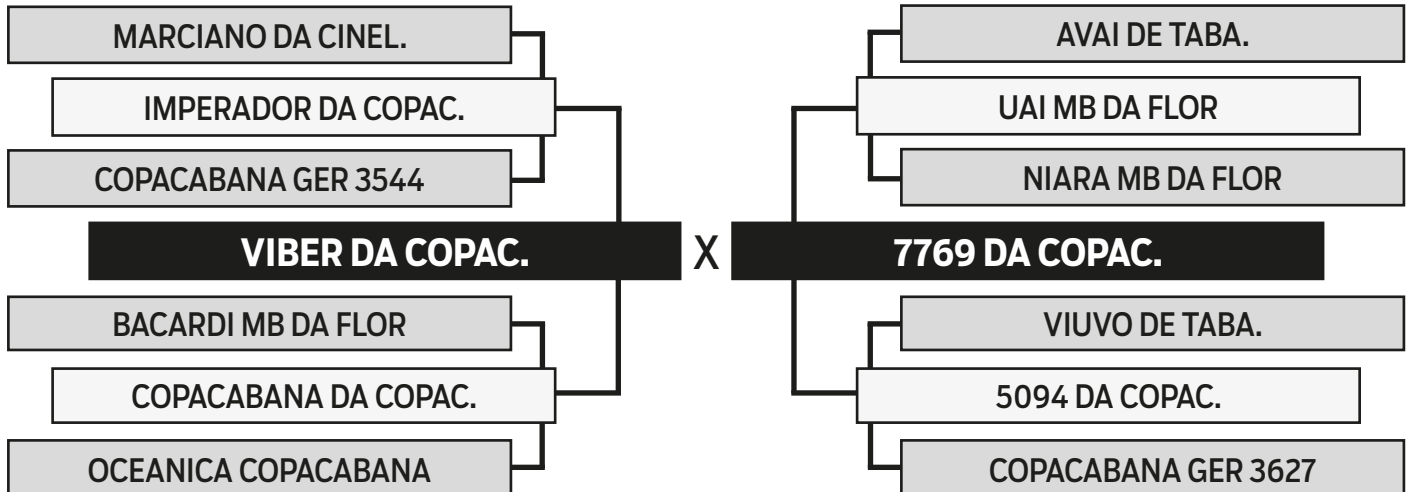

AVALIAÇÃO GENÉTICA - PMGZ



iABCZ: **9.69** - DECA: **2**

	PD-ED	PA-ED	PS-ED	PM-EM	TMD	IPP	STAY	PE-365	AOL	ACAB
DEP	5.05	7.45	11.47	2.42	5.96	2.48	30.54	0.69	1.22	-0.88
DECA	1	1	1	1	1	7	7	1	1	9



LEILÃO TABAPUÃ COPACABANA

LOTE

36

A319 DA COPAC.

R\$ **450,00**
x 30 parcelas
(2+2+2+2+2+2+18)
Valor por parcela

SEXO: **MACHO** - RAÇA: **TABAPUÃ PO** - REG: **GER A319** - NASC.: **23/01/2021**
PESO: **490 KG** - PE: **34 CM**



AVALIAÇÃO GENÉTICA - PMGZ



iABCZ: **11.95** - DECA: **1**

	PD-ED	PA-ED	PS-ED	PM-EM	TMD	IPP	STAY	PE-365	AOL	ACAB
DEP	5.78	9.38	11.74	0.41	4.14	1.60	33.03	0.32	0.88	0.51
DECA	1	1	1	5	1	7	3	1	2	3



LEILÃO TABAPUÃ COPACABANA

LOTE

37

A228 DA COPAC.

R\$ **450,00**
x 30 parcelas
(2+2+2+2+2+2+18)
Valor por parcela

SEXO: **MACHO** - RAÇA: **TABAPUÃ PO** - REG: **GER A228** - NASC.: **03/11/2020**
PESO: **496 KG** - PE: **36 CM**

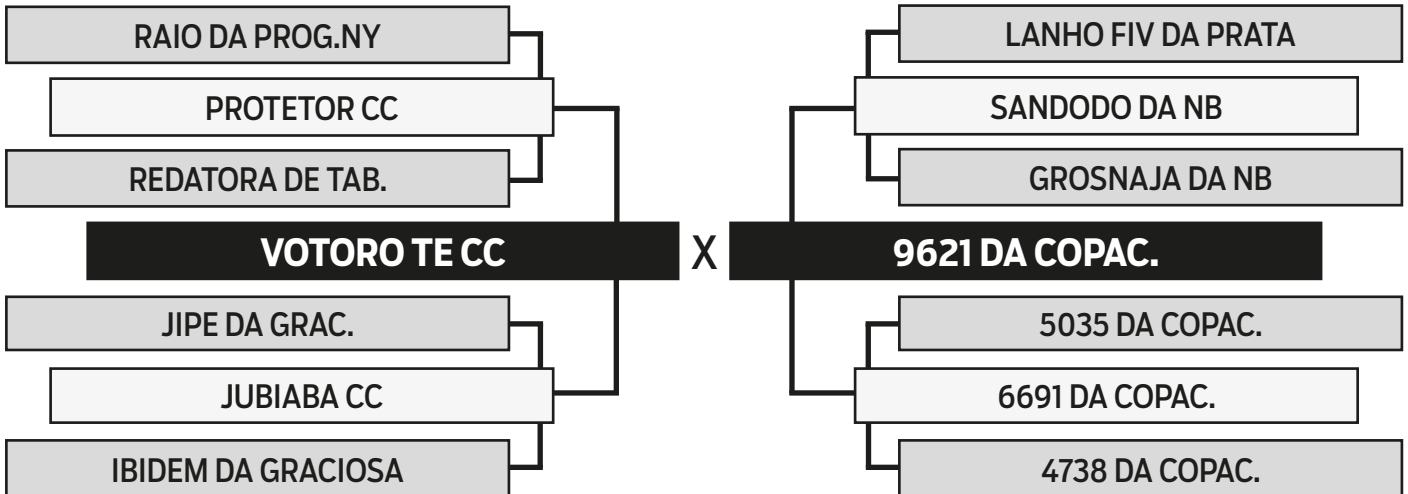

AVALIAÇÃO GENÉTICA - PMGZ



iABCZ: **1.78** - DECA: **5**

	PD-ED	PA-ED	PS-ED	PM-EM	TMD	IPP	STAY	PE-365	AOL	ACAB
DEP	2.15	4.03	5.46	0.74	1.69	-0.11	30.08	-0.07	0.77	0.17
DECA	4	3	3	3	4	6	8	7	2	5



LEILÃO TABAPUÃ COPACABANA

LOTE

38

A341 DA COPAC.

R\$ **400,00**
x 30 parcelas
(2+2+2+2+2+2+18)
Valor por parcela

SEXO: **MACHO** - RAÇA: **TABAPUÃ PO** - REG: **GER A341** - NASC.: **02/02/2021**
PESO: **451 KG** - PE: **34 CM**

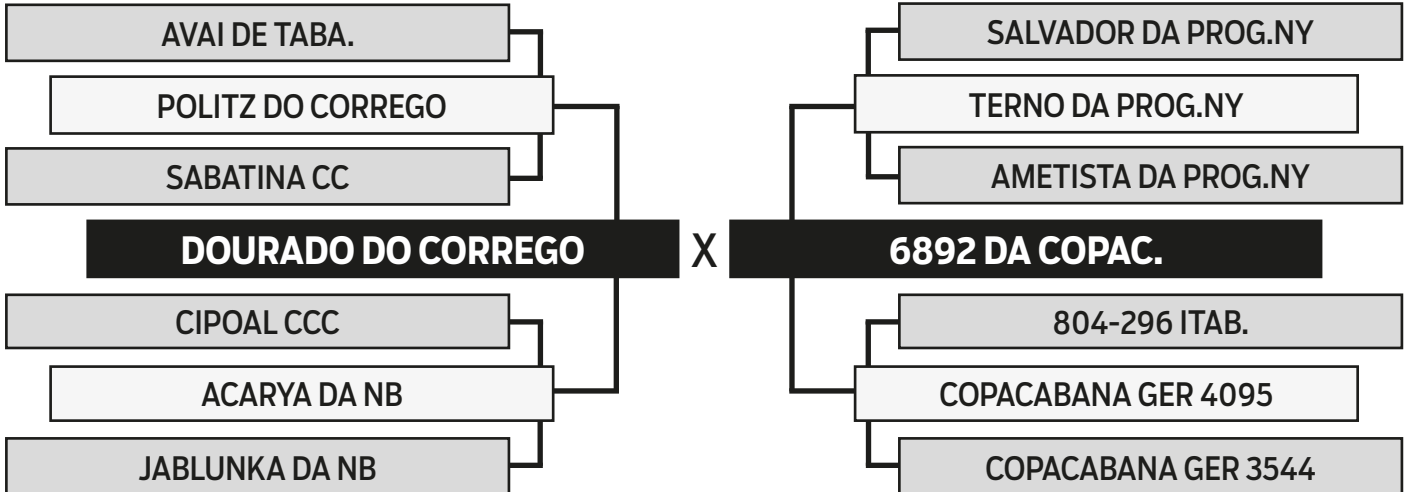

AVALIAÇÃO GENÉTICA - PMGZ



iABCZ: **9.75** - DECA: **2**

	PD-ED	PA-ED	PS-ED	PM-EM	TMD	IPP	STAY	PE-365	AOL	ACAB
DEP	8.81	8.10	10.85	-0.04	4.64	5.87	32.34	-0.01	0.85	1.28
DECA	1	1	1	6	1	8	4	6	2	1



LEILÃO TABAPUÃ COPACABANA

R\$ **450,00**
x 30 parcelas
(2+2+2+2+2+2+18)
Valor por parcela

LOTE

39

A343 DA COPAC.

SEXO: **MACHO** - RAÇA: **TABAPUÃ PO** - REG: **GER A343** - NASC.: **07/02/2021**
PESO: **464 KG** - PE: **30 CM**

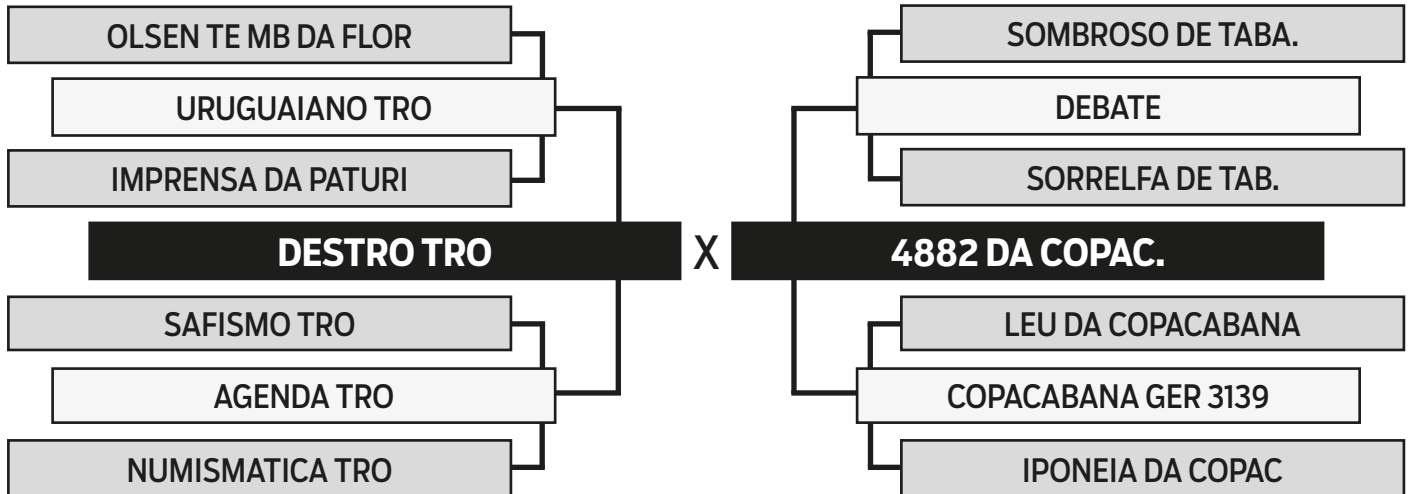

AVALIAÇÃO GENÉTICA - PMGZ



iABCZ: **11.10** - DECA: **1**

	PD-ED	PA-ED	PS-ED	PM-EM	TMD	IPP	STAY	PE-365	AOL	ACAB
DEP	7.18	7.75	7.13	2.52	5.90	-2.56	32.18	0.08	1.09	0.80
DECA	1	1	2	1	1	4	4	4	1	2



LEILÃO TABAPUÃ COPACABANA

LOTE

40

A348 DA COPAC.

R\$ **400,00**
x 30 parcelas
(2+2+2+2+2+2+18)
Valor por parcela

SEXO: **MACHO** - RAÇA: **TABAPUÃ PO** - REG: **GER A348** - NASC.: **07/02/2021**
PESO: **530 KG** - PE: **35 CM**

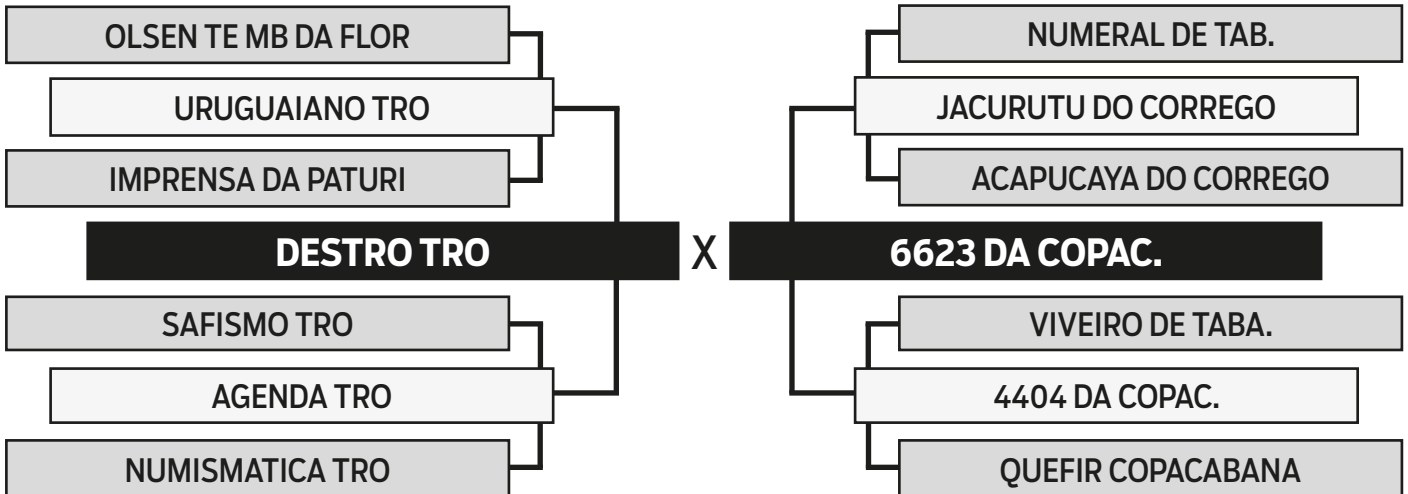

AVALIAÇÃO GENÉTICA - PMGZ



iABCZ: **7.36** - DECA: **3**

	PD-ED	PA-ED	PS-ED	PM-EM	TMD	IPP	STAY	PE-365	AOL	ACAB
DEP	5.08	5.70	6.80	1.48	3.85	1.16	32.04	-0.06	1.13	0.91
DECA	1	2	2	2	2	6	5	7	1	2



LEILÃO TABAPUÃ COPACABANA

LOTE

41

A354 DA COPAC.

R\$ **450,00**
x 30 parcelas
(2+2+2+2+2+2+18)
Valor por parcela

SEXO: **MACHO** - RAÇA: **TABAPUÃ PO** - REG: **GER A354** - NASC.: **09/02/2021**
PESO: **491 KG** - PE: **34 CM**

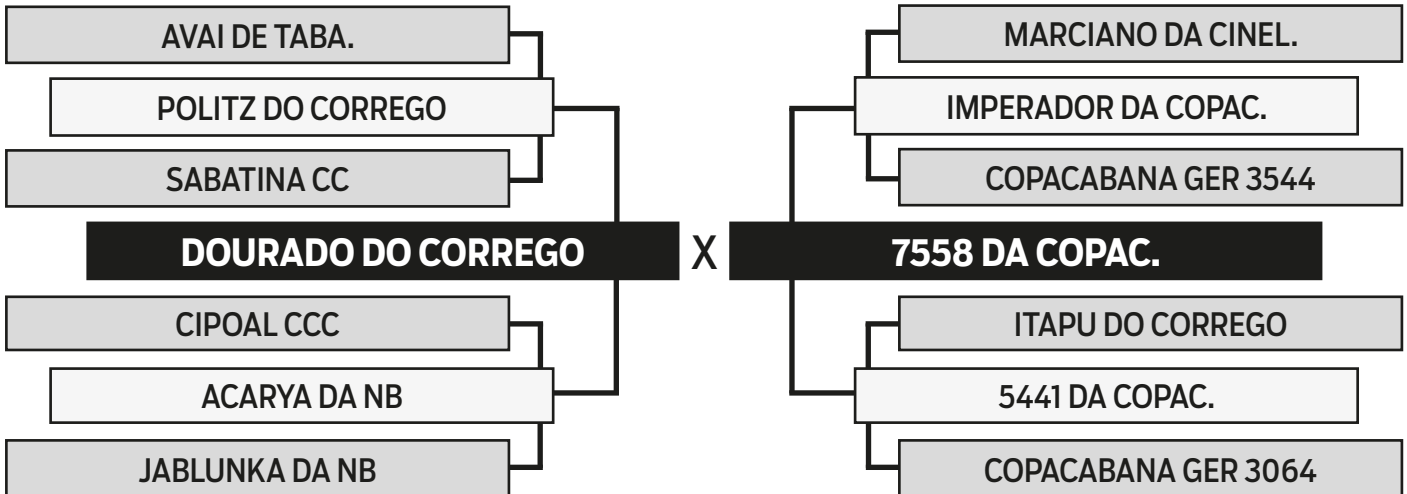

AVALIAÇÃO GENÉTICA - PMGZ



iABCZ: **10.47** - DECA: **1**

	PD-ED	PA-ED	PS-ED	PM-EM	TMD	IPP	STAY	PE-365	AOL	ACAB
DEP	3.33	6.96	11.17	-0.36	1.91	2.33	34.01	0.26	0.49	0.63
DECA	3	1	1	7	4	7	2	1	3	2



LEILÃO TABAPUÃ COPACABANA

LOTE

42

A401 DA COPAC.

R\$ **450,00**
x 30 parcelas
(2+2+2+2+2+2+18)
Valor por parcela

SEXO: **MACHO** - RAÇA: **TABAPUÃ PO** - REG: **GER A401** - NASC.: **31/03/2021**
PESO: **517 KG** - PE: **38 CM**

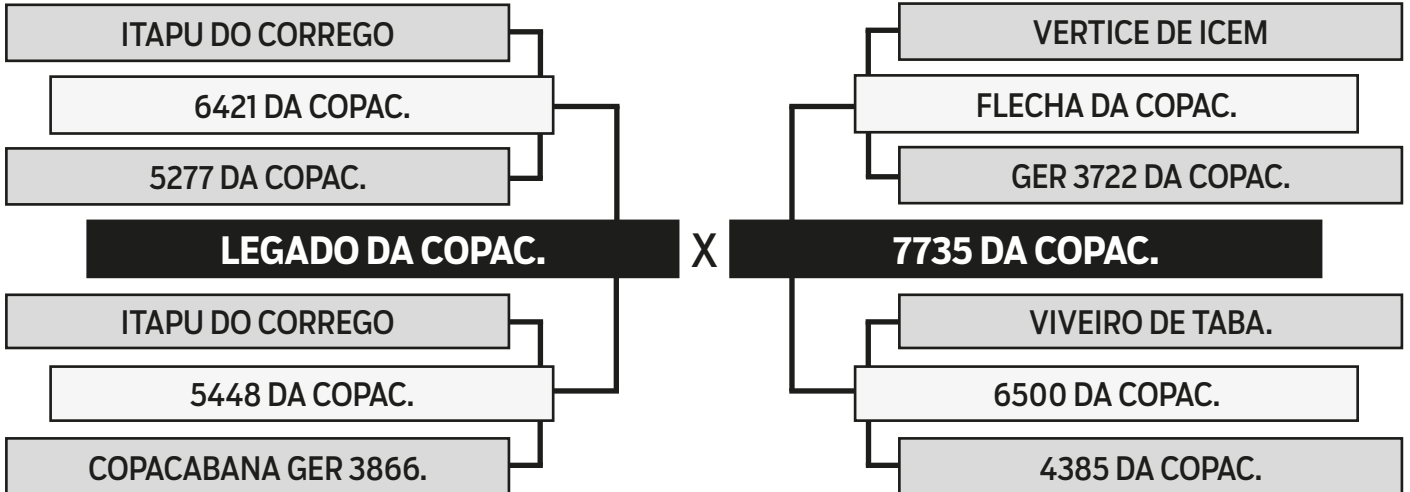

AVALIAÇÃO GENÉTICA - PMGZ



iABCZ: **11.83** - DECA: **1**

	PD-ED	PA-ED	PS-ED	PM-EM	TMD	IPP	STAY	PE-365	AOL	ACAB
DEP	5.34	7.04	8.39	0.22	2.74	-2.51	33.87	0.31	-0.19	-0.24
DECA	1	1	1	5	3	5	2	1	7	7



LEILÃO TABAPUÃ COPACABANA

R\$ **470,00**
x 30 parcelas
(2+2+2+2+2+2+18)
Valor por parcela

LOTE

43

9957 DA COPAC.

SEXO: **MACHO** - RAÇA: **TABAPUÃ PO** - REG: **GER 9957** - NASC.: **11/09/2019**
PESO: **745 KG** - PE: **36 CM**

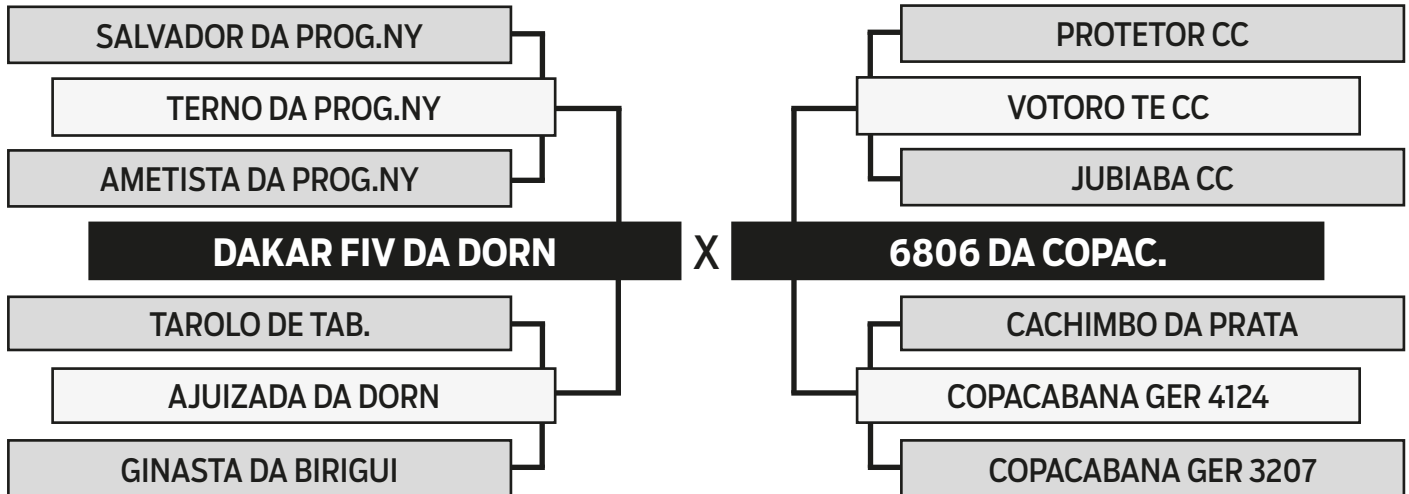

AVALIAÇÃO GENÉTICA - PMGZ



iABCZ: **10.85** - DECA: **1**

	PD-ED	PA-ED	PS-ED	PM-EM	TMD	IPP	STAY	PE-365	AOL	ACAB
DEP	5.56	8.69	10.36	0.74	3.98	-4.82	32.30	0.07	0.68	0.22
DECA	1	1	1	3	1	3	4	4	2	4



LEILÃO TABAPUÃ COPACABANA

R\$ **500,00**
x 30 parcelas
(2+2+2+2+2+2+18)
Valor por parcela

LOTE

44

9968 DA COPAC.

SEXO: **MACHO** - RAÇA: **TABAPUÃ PO** - REG: **GER 9968** - NASC.: **03/10/2019**
PESO: **790 KG** - PE: **41 CM**

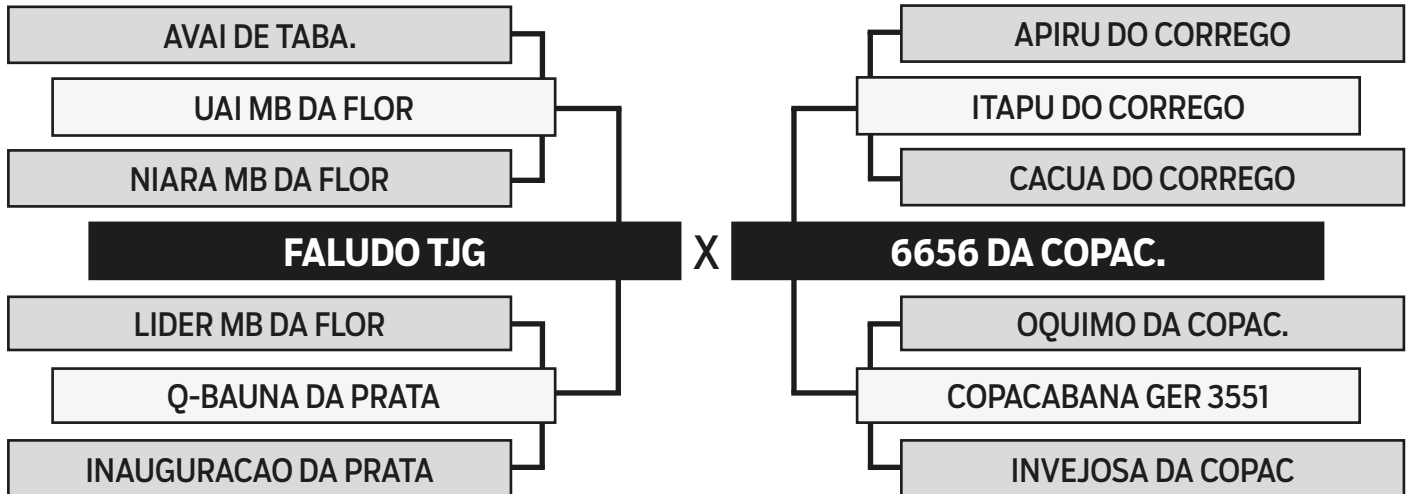

AVALIAÇÃO GENÉTICA - PMGZ



iABCZ: **15.07** - DECA: **1**

	PD-ED	PA-ED	PS-ED	PM-EM	TMD	IPP	STAY	PE-365	AOL	ACAB
DEP	3.39	7.04	10.88	1.20	3.75	-7.74	34.81	0.37	1.82	1.11
DECA	3	1	1	2	2	2	1	1	1	1



LEILÃO TABAPUÃ COPACABANA

R\$ **500,00**
x 30 parcelas
(2+2+2+2+2+2+18)
Valor por parcela

LOTE

45

9984 DA COPAC.

SEXO: **MACHO** - RAÇA: **TABAPUÃ PO** - REG: **GER 9984** - NASC.: **13/10/2019**
PESO: **762 KG** - PE: **44 CM**

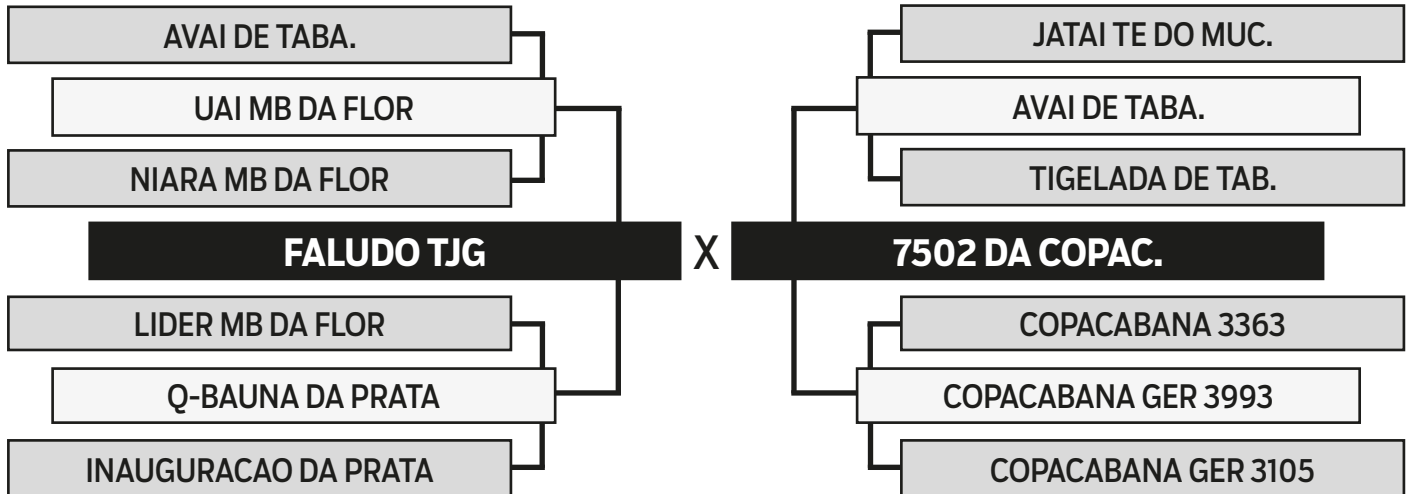

AVALIAÇÃO GENÉTICA - PMGZ



iABCZ: **14.46** - DECA: **1**

	PD-ED	PA-ED	PS-ED	PM-EM	TMD	IPP	STAY	PE-365	AOL	ACAB
DEP	3.08	7.72	11.18	0.10	2.61	-5.06	35.51	0.20	1.80	1.77
DECA	3	1	1	6	3	3	1	2	1	1



LEILÃO TABAPUÃ COPACABANA

R\$ **500,00**
x 30 parcelas
(2+2+2+2+2+2+18)
Valor por parcela

LOTE

46

9985 DA COPAC.

SEXO: **MACHO** - RAÇA: **TABAPUÃ PO** - REG: **GER 9985** - NASC.: **13/10/2019**
PESO: **740 KG** - PE: **40 CM**

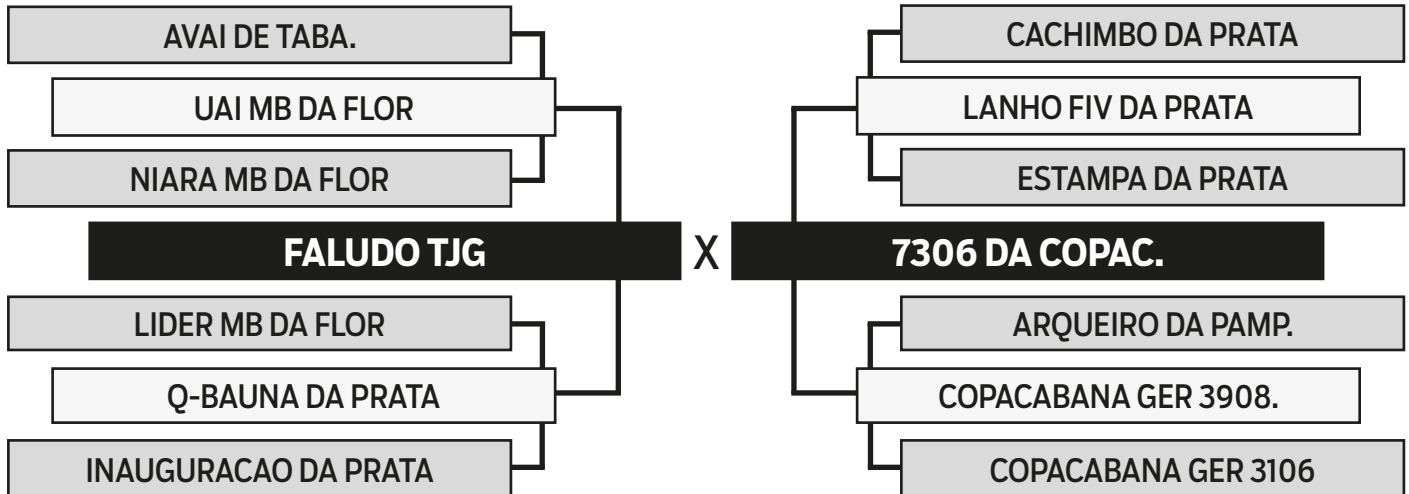

AVALIAÇÃO GENÉTICA - PMGZ



iABCZ: **15.02** - DECA: **1**

	PD-ED	PA-ED	PS-ED	PM-EM	TMD	IPP	STAY	PE-365	AOL	ACAB
DEP	3.78	7.58	14.30	-0.35	1.81	-2.85	35.71	0.21	1.77	1.25
DECA	2	1	1	7	4	4	1	2	1	1



LEILÃO TABAPUÃ COPACABANA

R\$ **470,00**
x 30 parcelas
(2+2+2+2+2+2+18)
Valor por parcela

LOTE

47

9989 DA COPAC.

SEXO: **MACHO** - RAÇA: **TABAPUÃ PO** - REG: **GER 9989** - NASC.: **20/10/2019**
PESO: **720 KG** - PE: **42.5 CM**

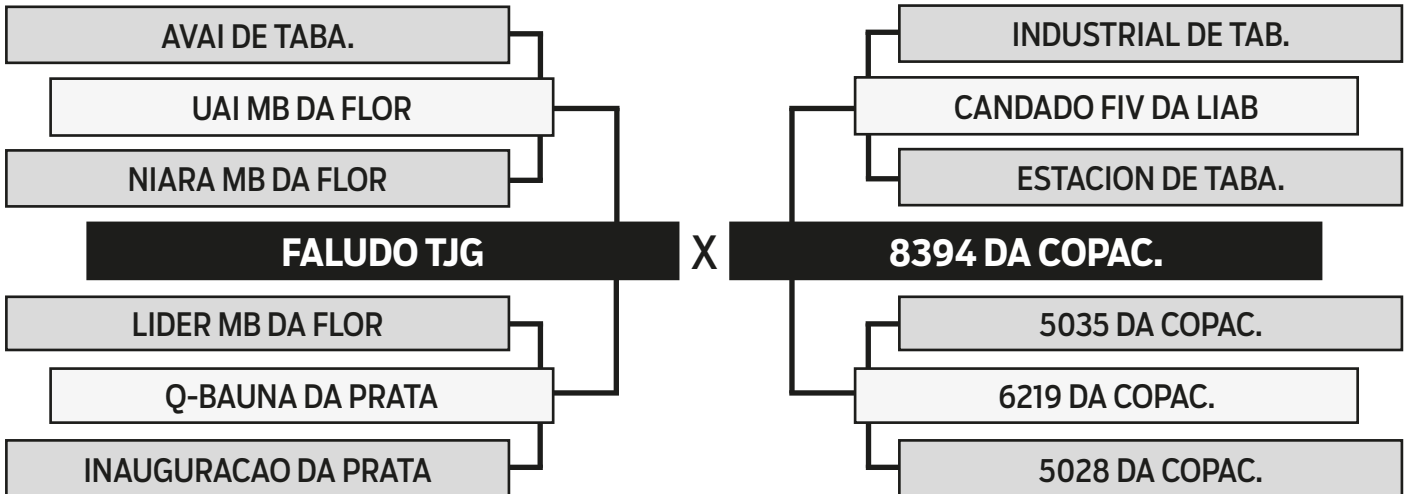

AVALIAÇÃO GENÉTICA - PMGZ



iABCZ: **14.83** - DECA: **1**

	PD-ED	PA-ED	PS-ED	PM-EM	TMD	IPP	STAY	PE-365	AOL	ACAB
DEP	3.37	6.61	12.39	-1.05	0.74	-0.65	36.87	0.22	1.63	0.92
DECA	3	1	1	9	5	5	1	2	1	2



LEILÃO TABAPUÃ COPACABANA

R\$ **470,00**
x 30 parcelas
(2+2+2+2+2+2+18)
Valor por parcela

LOTE

48

9 DA COPAC.

SEXO: **MACHO** - RAÇA: **TABAPUÃ PO** - REG: **GER A9** - NASC.: **08/11/2019**
PESO: **678 KG** - PE: **38 CM**

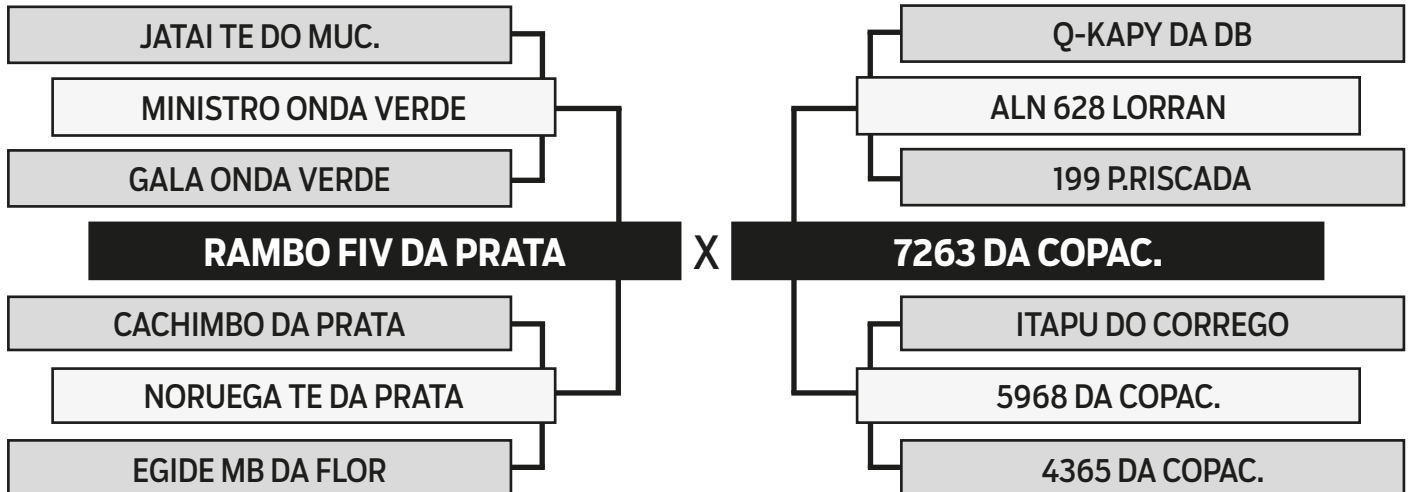

AVALIAÇÃO GENÉTICA - PMGZ



iABCZ: **13.50** - DECA: **1**

	PD-ED	PA-ED	PS-ED	PM-EM	TMD	IPP	STAY	PE-365	AOL	ACAB
DEP	6.05	9.14	10.39	2.30	6.10	-6.40	32.16	0.41	1.96	-0.03
DECA	1	1	1	1	1	3	4	1	1	6



LEILÃO TABAPUÃ COPACABANA

R\$ **470,00**
x 30 parcelas
(2+2+2+2+2+2+18)
Valor por parcela

LOTE **49**

20 DA COPAC.

SEXO: **MACHO** - RAÇA: **TABAPUÃ PO** - REG: **GER A20** - NASC.: **15/11/2019**
PESO: **720 KG** - PE: **40.5 CM**

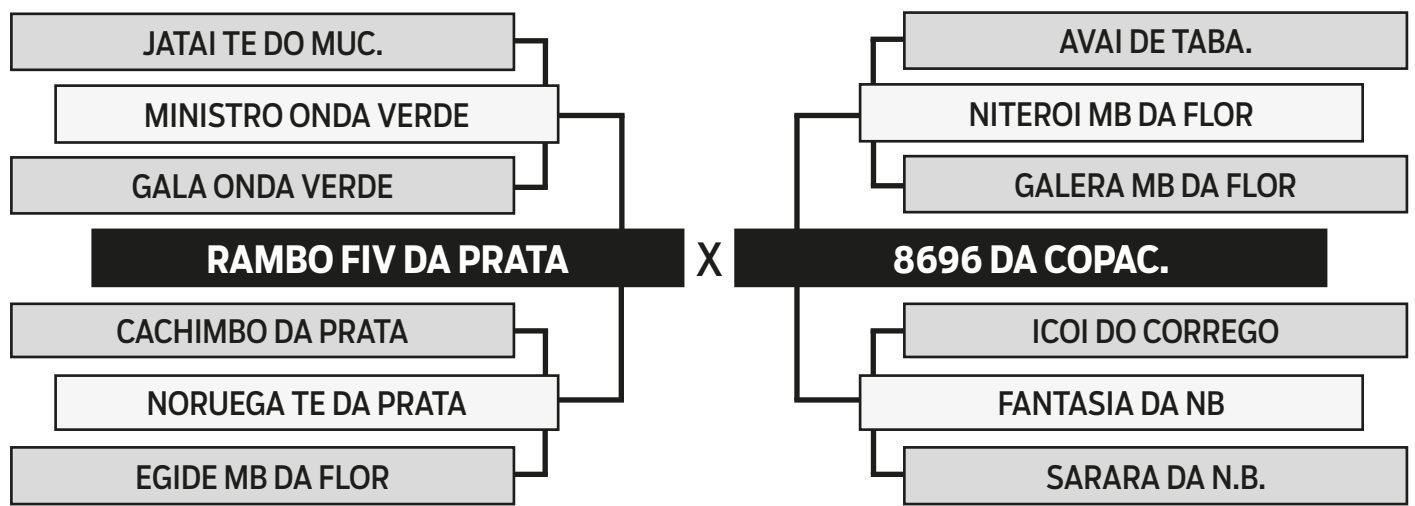

AVALIAÇÃO GENÉTICA - PMGZ



iABCZ: **11.66** - DECA: **1**

	PD-ED	PA-ED	PS-ED	PM-EM	TMD	IPP	STAY	PE-365	AOL	ACAB
DEP	4.39	8.21	12.38	1.53	3.93	-8.72	31.94	0.17	1.12	-0.20
DECA	2	1	1	2	1	2	5	3	1	7



LEILÃO TABAPUÃ COPACABANA

R\$ **500,00**
x 30 parcelas
(2+2+2+2+2+2+18)
Valor por parcela

LOTE

50

43 DA COPAC.

SEXO: MACHO - RAÇA: TABAPUÃ PO - REG: GER A43 - NASC.: 28/11/2019
PESO: 705 KG - PE: 35 CM

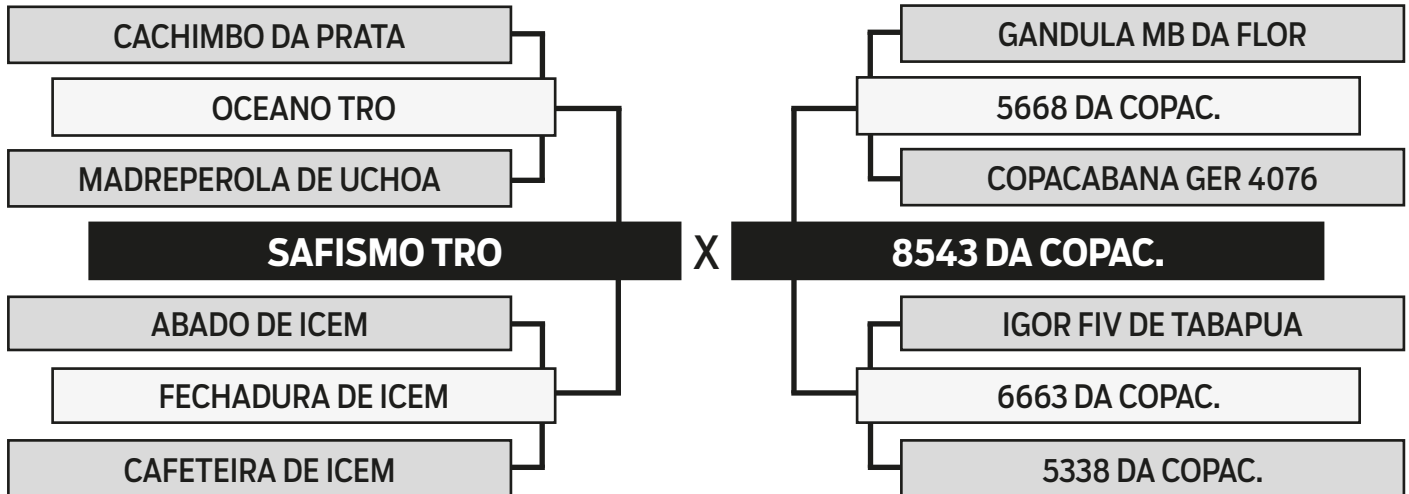

AVALIAÇÃO GENÉTICA - PMGZ



iABCZ: **1.75** - DECA: **5**

	PD-ED	PA-ED	PS-ED	PM-EM	TMD	IPP	STAY	PE-365	AOL	ACAB
DEP	2.60	4.44	5.80	0.74	1.97	2.26	30.18	-0.13	0.65	1.54
DECA	3	3	2	3	3	7	8	8	3	1



LEILÃO TABAPUÃ COPAÇABANA

R\$ **470,00**
x 30 parcelas
(2+2+2+2+2+2+18)
Valor por parcela

LOTE

51

A58 DA COPAC.

SEXO: **MACHO** - RAÇA: **TABAPUÃ PO** - REG: **GER A58** - NASC.: **23/12/2019**
PESO: **697 KG** - PE: **36 CM**

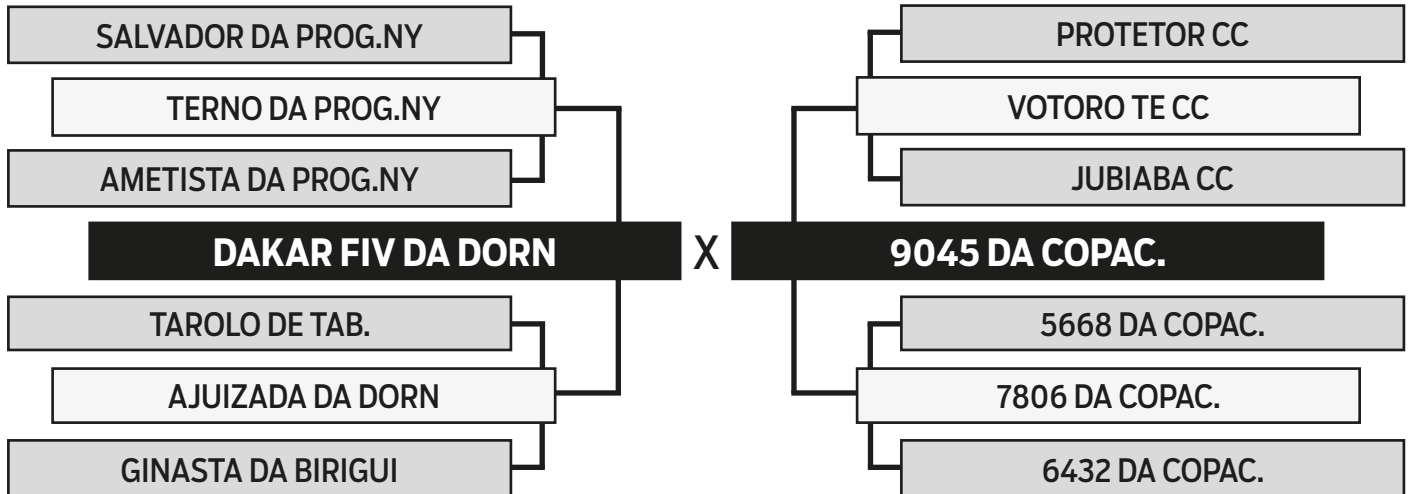

AVALIAÇÃO GENÉTICA - PMGZ



iABCZ: **7.96** - DECA: **2**

	PD-ED	PA-ED	PS-ED	PM-EM	TMD	IPP	STAY	PE-365	AOL	ACAB
DEP	4.91	6.44	7.55	-0.08	2.43	-8.63	31.59	0.01	0.48	0.59
DECA	1	1	2	6	3	2	5	6	3	3



LEILÃO TABAPUÃ COPACABANA

LOTE

53

A68 DA COPAC.

R\$ **470,00**
x 30 parcelas
(2+2+2+2+2+2+18)
Valor por parcela

SEXO: **MACHO** - RAÇA: **TABAPUÃ PO** - REG: **GER A68** - NASC.: **18/01/2020**
PESO: **734 KG** - PE: **37 CM**

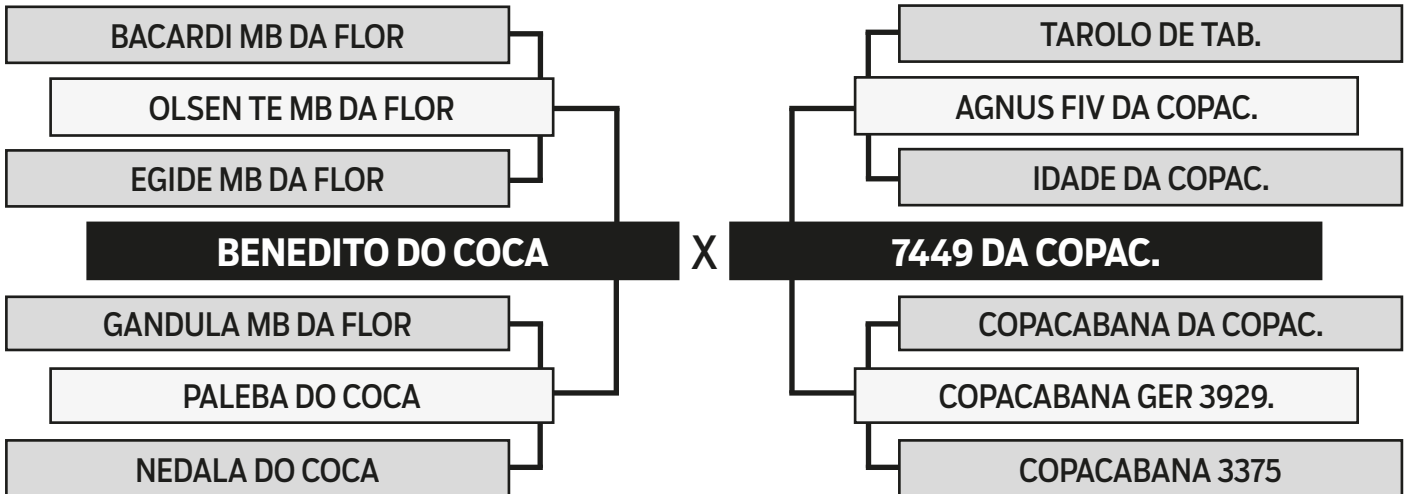

AVALIAÇÃO GENÉTICA - PMGZ



iABCZ: **13.23** - DECA: **1**

	PD-ED	PA-ED	PS-ED	PM-EM	TMD	IPP	STAY	PE-365	AOL	ACAB
DEP	4.07	7.95	8.22	1.36	4.03	3.46	35.95	-0.09	1.87	0.21
DECA	2	1	1	2	1	7	1	8	1	4



LEILÃO TABAPUÃ COPACABANA

R\$ **500,00**
x 30 parcelas
(2+2+2+2+2+2+18)
Valor por parcela

LOTE **54**

A73 DA COPAC.

SEXO: **MACHO** - RAÇA: **TABAPUÃ PO** - REG: **GER A73** - NASC.: **21/01/2020**
PESO: **753 KG** - PE: **38 CM**

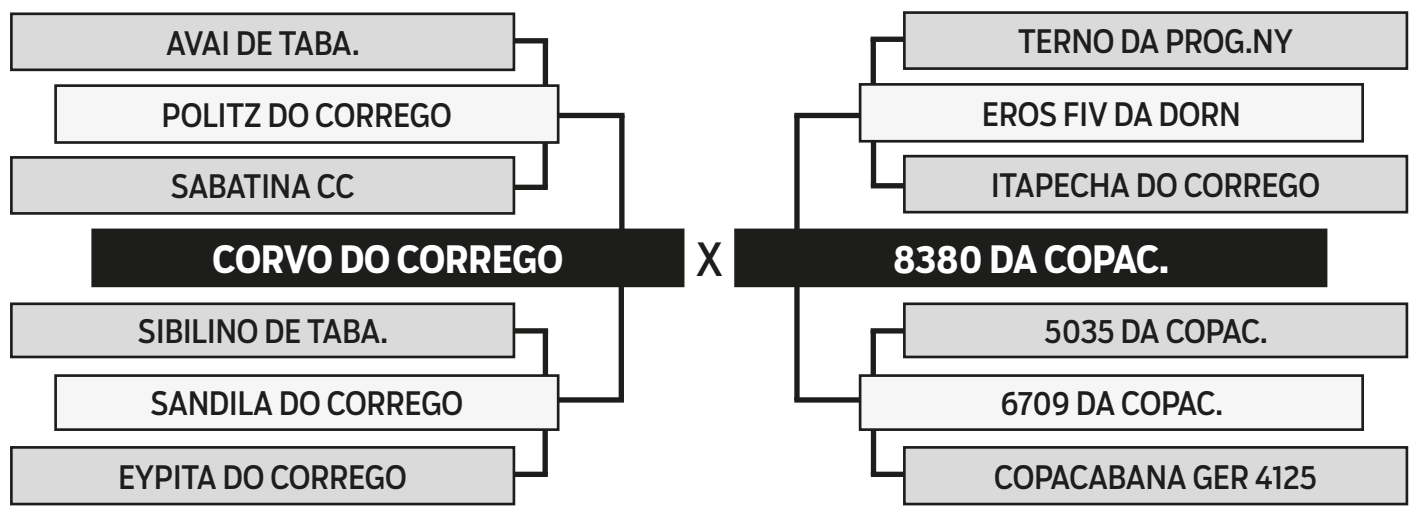

AVALIAÇÃO GENÉTICA - PMGZ



iABCZ: **13.37** - DECA: **1**

	PD-ED	PA-ED	PS-ED	PM-EM	TMD	IPP	STAY	PE-365	AOL	ACAB
DEP	5.00	7.22	9.10	0.23	2.99	-3.84	35.13	0.03	0.99	1.80
DECA	1	1	1	5	2	4	1	5	1	1



LEILÃO TABAPUÃ COPACABANA

R\$ **450,00**
x 30 parcelas
(2+2+2+2+2+2+18)
Valor por parcela

LOTE

55

A161 DA COPAC.

SEXO: **MACHO** - RAÇA: **TABAPUÃ PO** - REG: **GER A161** - NASC.: **27/09/2020**
PESO: **540 KG** - PE: **36 CM**

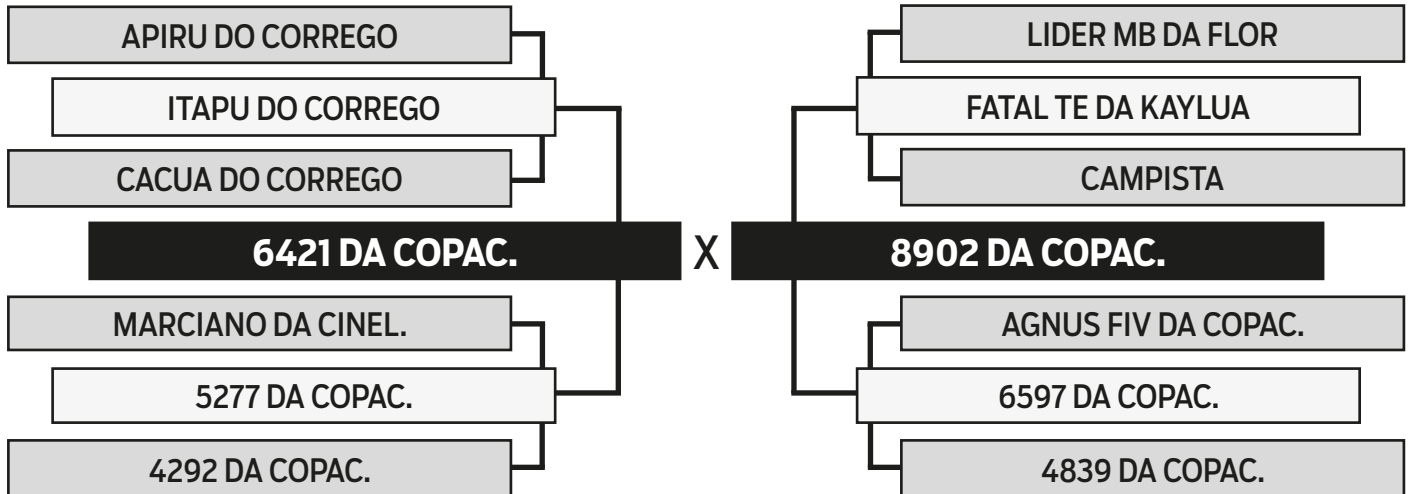

AVALIAÇÃO GENÉTICA - PMGZ



iABCZ: **18.48** - DECA: **1**

	PD-ED	PA-ED	PS-ED	PM-EM	TMD	IPP	STAY	PE-365	AOL	ACAB
DEP	11.73	14.30	16.49	0.42	6.48	-11.88	32.24	0.21	2.03	0.62
DECA	1	1	1	5	1	1	4	2	1	2



LEILÃO TABAPUÃ COPACABANA

LOTE

56

A89 DA COPAC.

R\$ **470,00**
x 30 parcelas
(2+2+2+2+2+2+18)
Valor por parcela

SEXO: **MACHO** - RAÇA: **TABAPUÃ PO** - REG: **GER A89** - NASC.: **29/01/2020**
PESO: **721 KG** - PE: **40 CM**



AVALIAÇÃO GENÉTICA - PMGZ



iABCZ: **15.23** - DECA: **1**

	PD-ED	PA-ED	PS-ED	PM-EM	TMD	IPP	STAY	PE-365	AOL	ACAB
DEP	4.86	7.64	11.11	1.59	4.24	-3.02	35.20	0.15	2.02	1.95
DECA	1	1	1	2	1	4	1	3	1	1



LEILÃO TABAPUÃ COPACABANA

R\$ **450,00**
x 30 parcelas
(2+2+2+2+2+2+18)
Valor por parcela

LOTE

57

A119 DA COPAC.

SEXO: **MACHO** - RAÇA: **TABAPUÃ PO** - REG: **GER A119** - NASC.: **13/03/2020**
PESO: **620 KG** - PE: **39 CM**

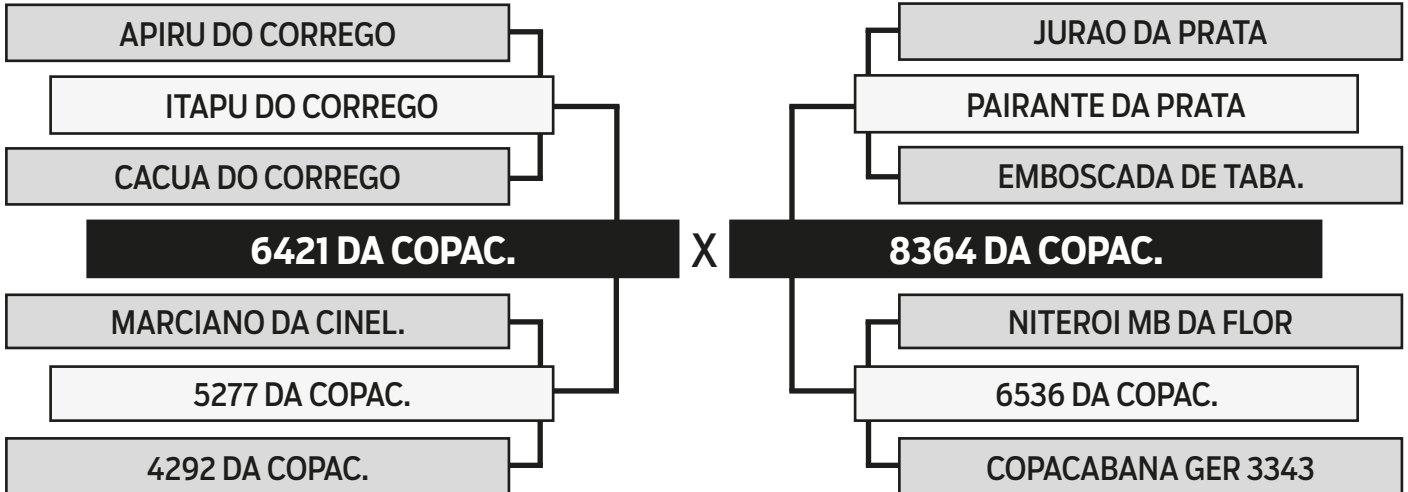

AVALIAÇÃO GENÉTICA - PMGZ



iABCZ: **17.95** - DECA: **1**

	PD-ED	PA-ED	PS-ED	PM-EM	TMD	IPP	STAY	PE-365	AOL	ACAB
DEP	7.12	9.33	9.31	1.10	4.67	-10.05	35.68	0.15	1.14	0.40
DECA	1	1	1	3	1	2	1	3	1	3



LEILÃO TABAPUÃ COPACABANA

R\$ **450,00**
x 30 parcelas
(2+2+2+2+2+2+18)
Valor por parcela

LOTE

58

A123 DA COPAC.

SEXO: **MACHO** - RAÇA: **TABAPUÃ PO** - REG: **GER A123** - NASC.: **14/03/2020**
PESO: **674 KG** - PE: **40 CM**

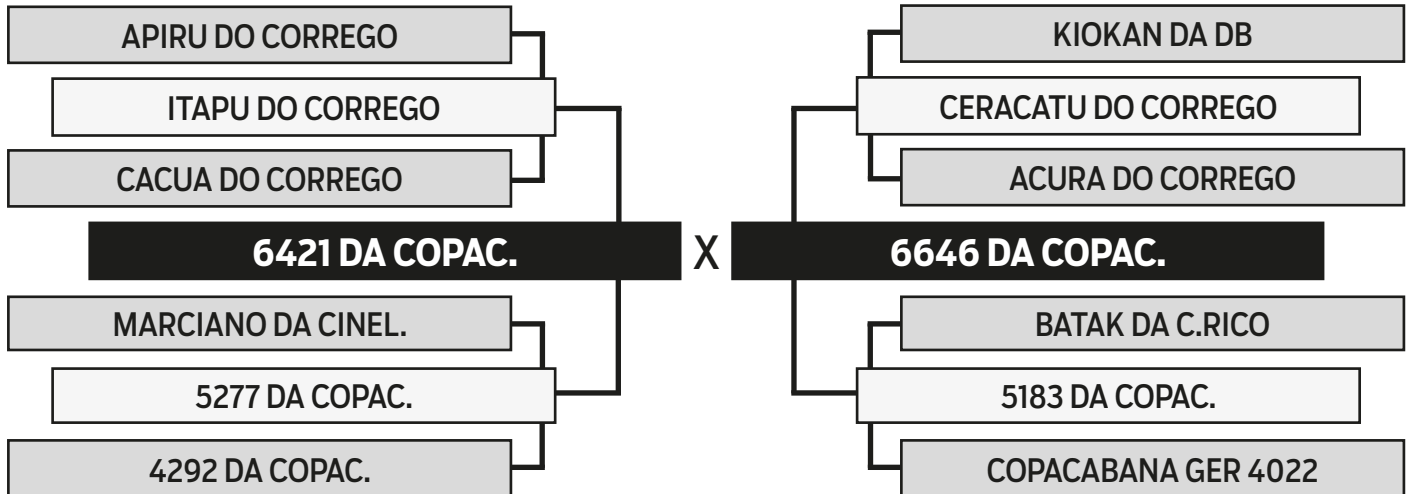

AVALIAÇÃO GENÉTICA - PMGZ



iABCZ: **22.60** - DECA: **1**

	PD-ED	PA-ED	PS-ED	PM-EM	TMD	IPP	STAY	PE-365	AOL	ACAB
DEP	10.14	13.68	14.84	1.72	7.36	-15.12	35.04	0.10	2.96	0.72
DECA	1	1	1	1	1	1	1	4	1	2



LEILÃO TABAPUÃ COPACABANA

R\$ **400,00**
x 30 parcelas
(2+2+2+2+2+2+18)
Valor por parcela

LOTE

59

A147 DA COPAC.

SEXO: **MACHO** - RAÇA: **TABAPUÃ PO** - REG: **GER A147** - NASC.: **23/03/2020**
PESO: **663 KG** - PE: **39 CM**

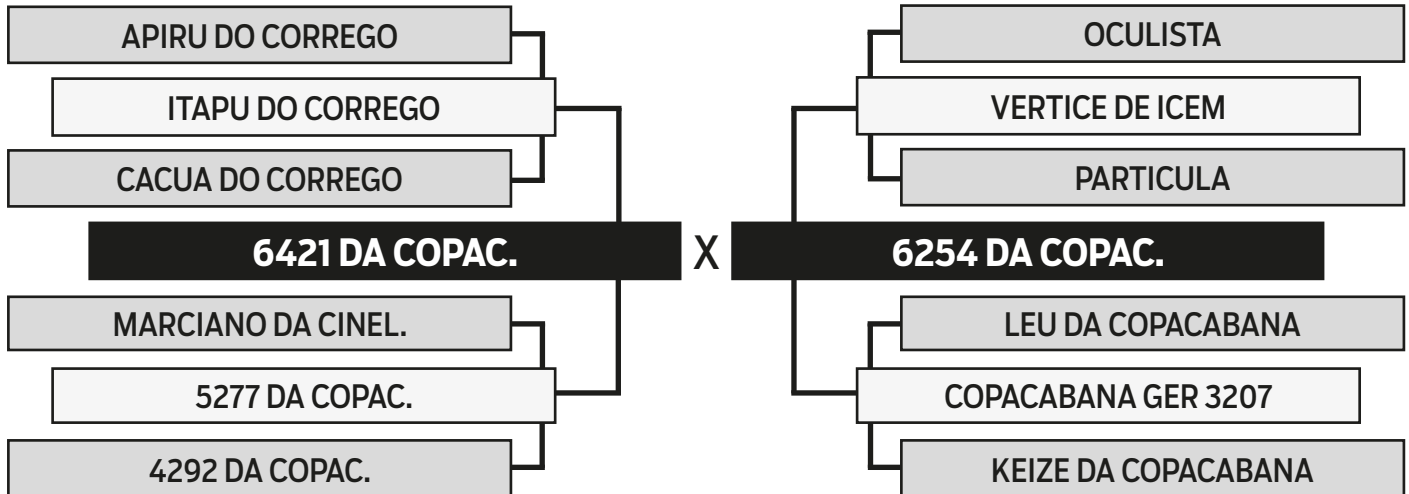

AVALIAÇÃO GENÉTICA - PMGZ



iABCZ: **19.37** - DECA: **1**

	PD-ED	PA-ED	PS-ED	PM-EM	TMD	IPP	STAY	PE-365	AOL	ACAB
DEP	6.18	10.70	15.20	0.90	4.25	-6.84	36.07	0.17	1.54	-0.14
DECA	1	1	1	3	1	3	1	3	1	6



LEILÃO TABAPUÃ COPACABANA

R\$ **450,00**
x 30 parcelas
(2+2+2+2+2+2+18)
Valor por parcela

LOTE

60

A158 DA COPAC.

SEXO: **MACHO** - RAÇA: **TABAPUÃ PO** - REG: **GER A158** - NASC.: **25/09/2020**
PESO: **604 KG** - PE: **39 CM**

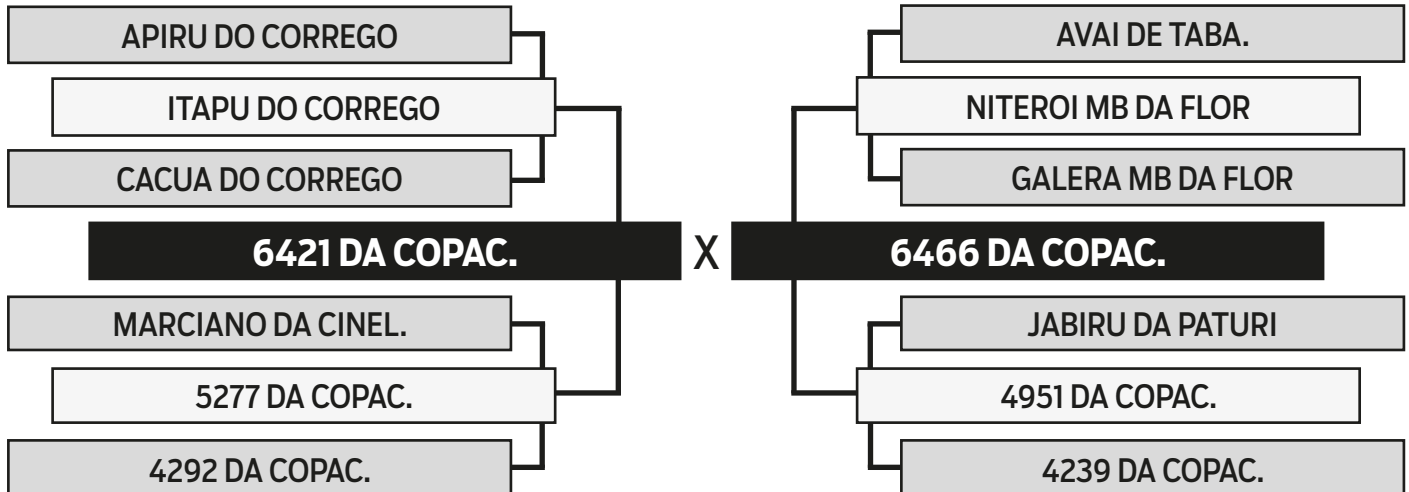

AVALIAÇÃO GENÉTICA - PMGZ



iABCZ: **16.32** - DECA: **1**

	PD-ED	PA-ED	PS-ED	PM-EM	TMD	IPP	STAY	PE-365	AOL	ACAB
DEP	8.64	11.15	12.87	1.22	5.74	-4.98	33.79	0.08	1.72	0.11
DECA	1	1	1	2	1	3	2	4	1	5



LEILÃO TABAPUÃ COPACABANA

R\$ **400,00**
x 30 parcelas
(2+2+2+2+2+2+18)
Valor por parcela

LOTE

61

A160 DA COPAC.

SEXO: **MACHO** - RAÇA: **TABAPUÃ PO** - REG: **GER A160** - NASC.: **27/09/2020**
PESO: **490 KG** - PE: **36 CM**

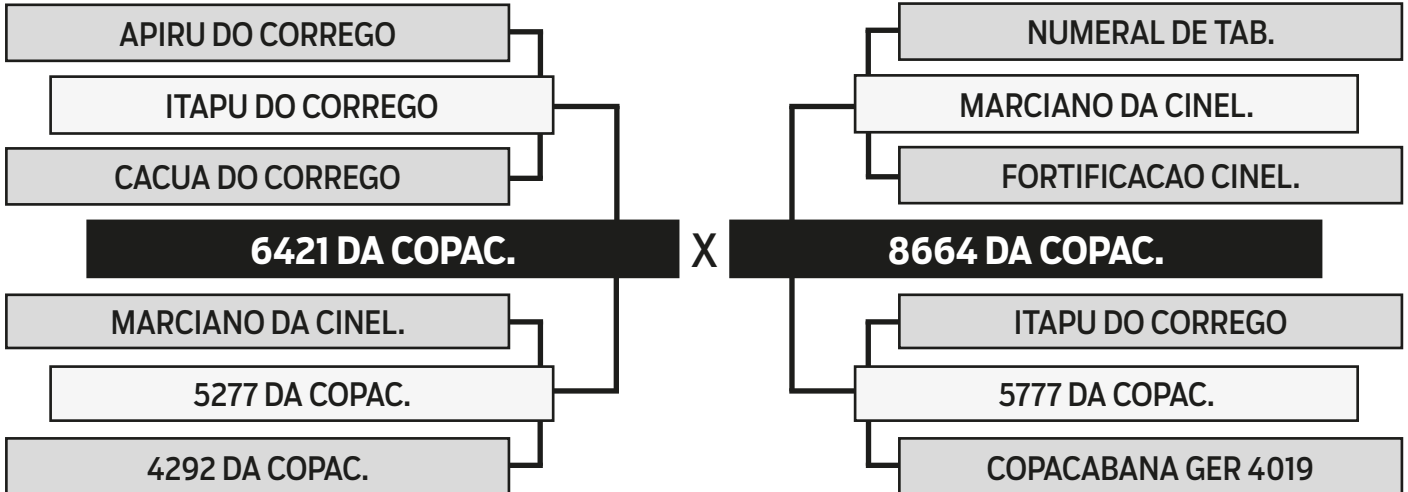

AVALIAÇÃO GENÉTICA - PMGZ



iABCZ: **10.73** - DECA: **1**

	PD-ED	PA-ED	PS-ED	PM-EM	TMD	IPP	STAY	PE-365	AOL	ACAB
DEP	3.40	6.01	7.11	0.25	2.00	-8.27	34.00	0.01	2.19	-0.09
DECA	3	2	2	5	3	2	2	6	1	6



LEILÃO TABAPUÃ COPACABANA

LOTE

62

A164 DA COPAC.

R\$ **470,00**
x 30 parcelas
(2+2+2+2+2+2+18)
Valor por parcela

SEXO: **MACHO** - RAÇA: **TABAPUÃ PO** - REG: **GER A164** - NASC.: **27/09/2020**
PESO: **630 KG** - PE: **34 CM**

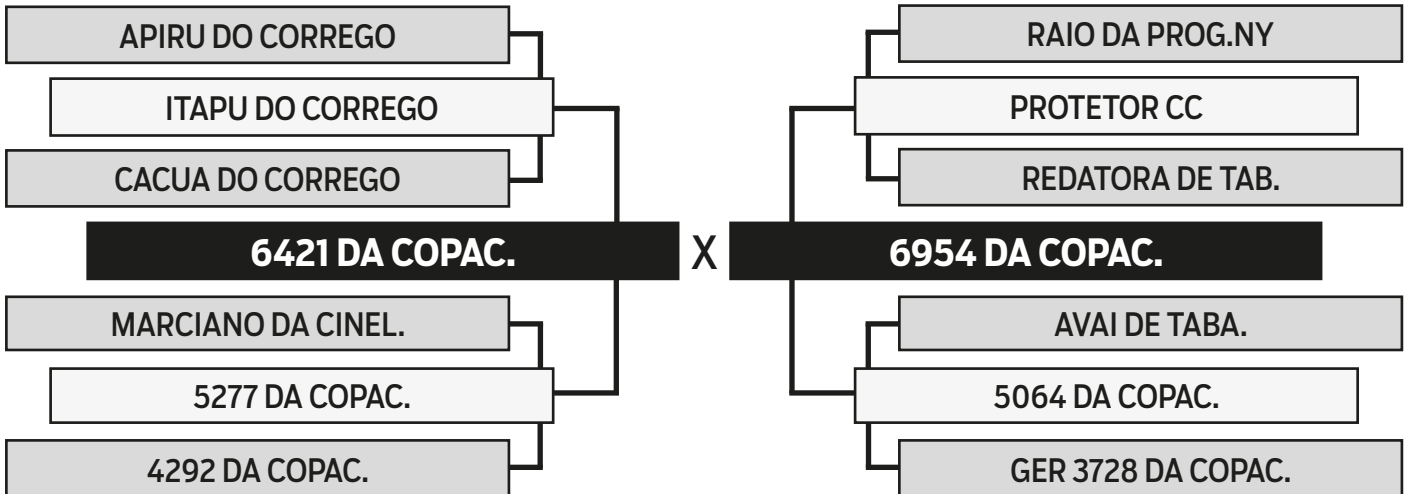

AVALIAÇÃO GENÉTICA - PMGZ



iABCZ: **18.15** - DECA: **1**

	PD-ED	PA-ED	PS-ED	PM-EM	TMD	IPP	STAY	PE-365	AOL	ACAB
DEP	11.77	14.16	16.18	1.38	7.47	-1.45	33.26	0.05	1.80	0.00
DECA	1	1	1	2	1	5	3	5	1	5



LEILÃO TABAPUÃ COPACABANA

R\$ **400,00**
x 30 parcelas
(2+2+2+2+2+2+18)
Valor por parcela

LOTE

63

A177 DA COPAC.

SEXO: **MACHO** - RAÇA: **TABAPUÃ PO** - REG: **GER A177** - NASC.: **03/10/2020**
PESO: **521 KG** - PE: **35 CM**

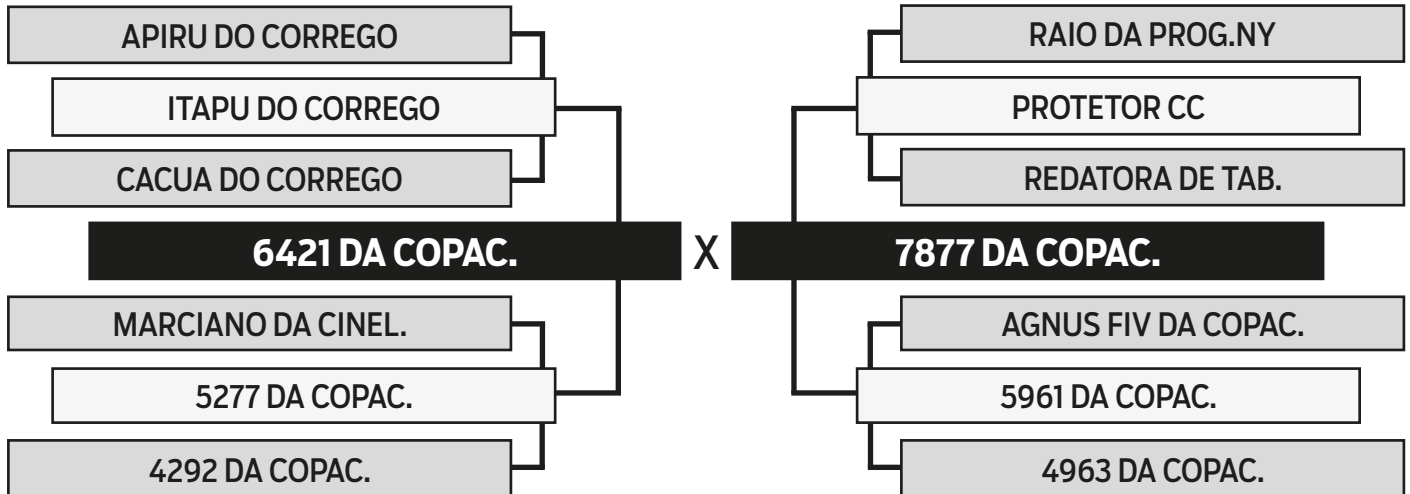

AVALIAÇÃO GENÉTICA - PMGZ



iABCZ: **16.86** - DECA: **1**

	PD-ED	PA-ED	PS-ED	PM-EM	TMD	IPP	STAY	PE-365	AOL	ACAB
DEP	12.00	12.73	14.97	0.44	6.32	-2.76	32.97	0.13	1.71	-0.27
DECA	1	1	1	4	1	4	3	3	1	7



LEILÃO TABAPUÃ COPACABANA

R\$ **470,00**
x 30 parcelas
(2+2+2+2+2+2+18)
Valor por parcela

LOTE

64

A182 DA COPAC.

SEXO: **MACHO** - RAÇA: **TABAPUÃ PO** - REG: **GER A182** - NASC.: **04/10/2020**
PESO: **541 KG** - PE: **35 CM**

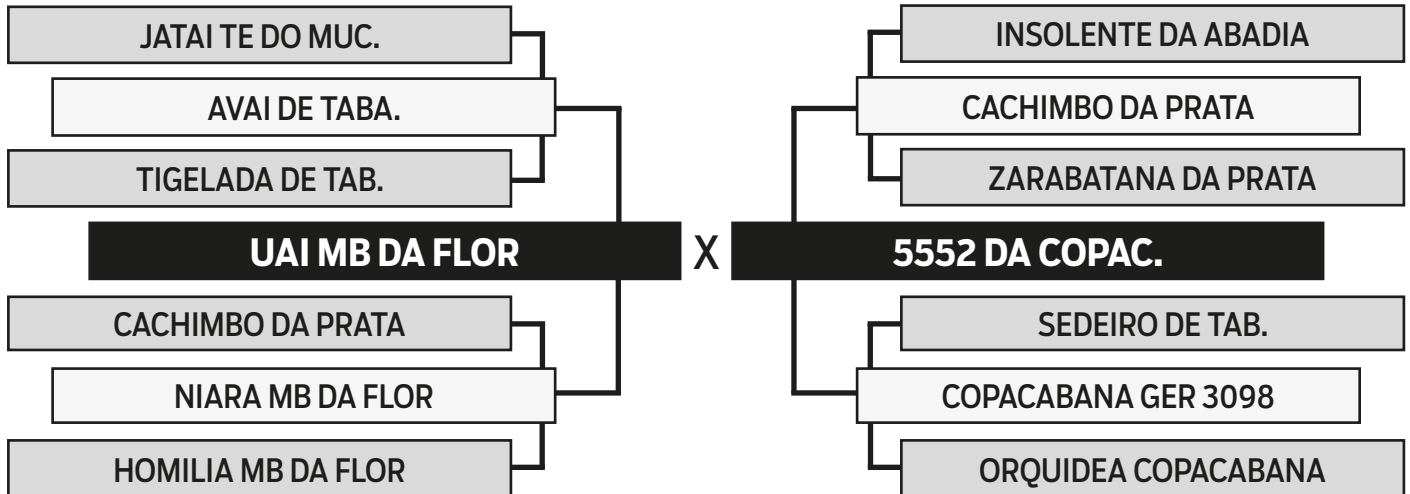

AVALIAÇÃO GENÉTICA - PMGZ



iABCZ: **6.43** - DECA: **3**

	PD-ED	PA-ED	PS-ED	PM-EM	TMD	IPP	STAY	PE-365	AOL	ACAB
DEP	5.34	7.46	12.49	4.25	8.12	7.77	28.11	0.54	1.45	-0.81
DECA	1	1	1	1	1	9	10	1	1	9



LEILÃO TABAPUÃ COPACABANA

LOTE

65

A183 DA COPAC.

R\$ **450,00**
x 30 parcelas
(2+2+2+2+2+2+18)
Valor por parcela

SEXO: **MACHO** - RAÇA: **TABAPUÃ PO** - REG: **GER A183** - NASC.: **04/10/2020**
PESO: **510 KG** - PE: **37 CM**

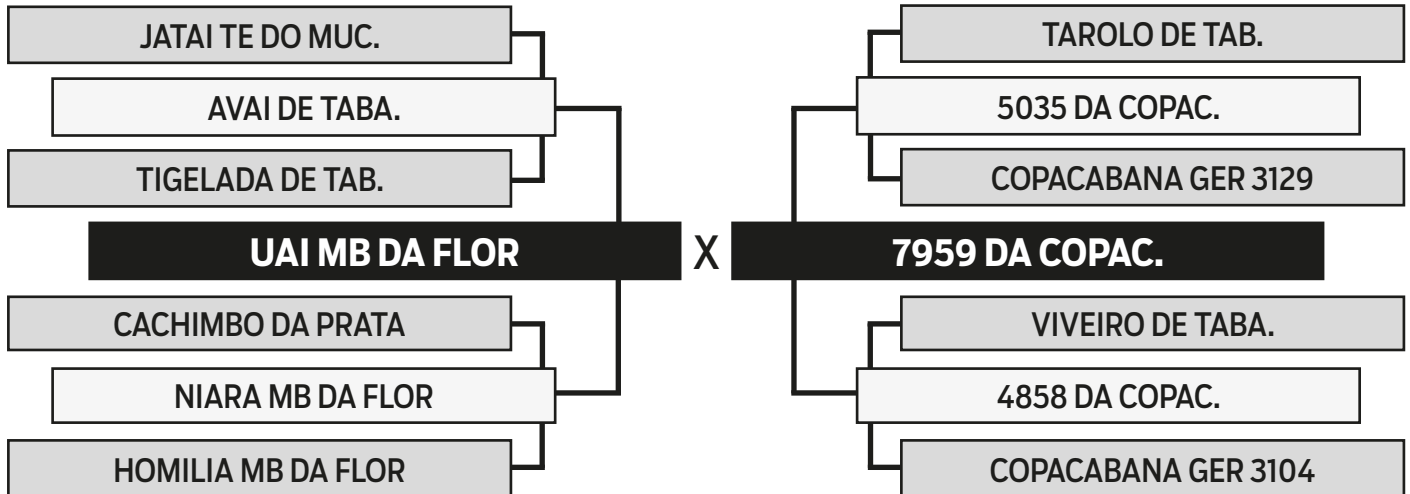

AVALIAÇÃO GENÉTICA - PMGZ



iABCZ: **6.94** - DECA: **3**

	PD-ED	PA-ED	PS-ED	PM-EM	TMD	IPP	STAY	PE-365	AOL	ACAB
DEP	3.12	5.35	6.91	2.89	5.24	6.63	31.40	0.43	1.31	-0.24
DECA	3	2	2	1	1	9	6	1	1	7



LEILÃO TABAPUÃ COPACABANA

LOTE

66

A188 DA COPAC.

R\$ **450,00**
x 30 parcelas
(2+2+2+2+2+2+18)
Valor por parcela

SEXO: **MACHO** - RAÇA: **TABAPUÃ PO** - REG: **GER A188** - NASC.: **04/10/2020**
PESO: **564 KG** - PE: **35 CM**

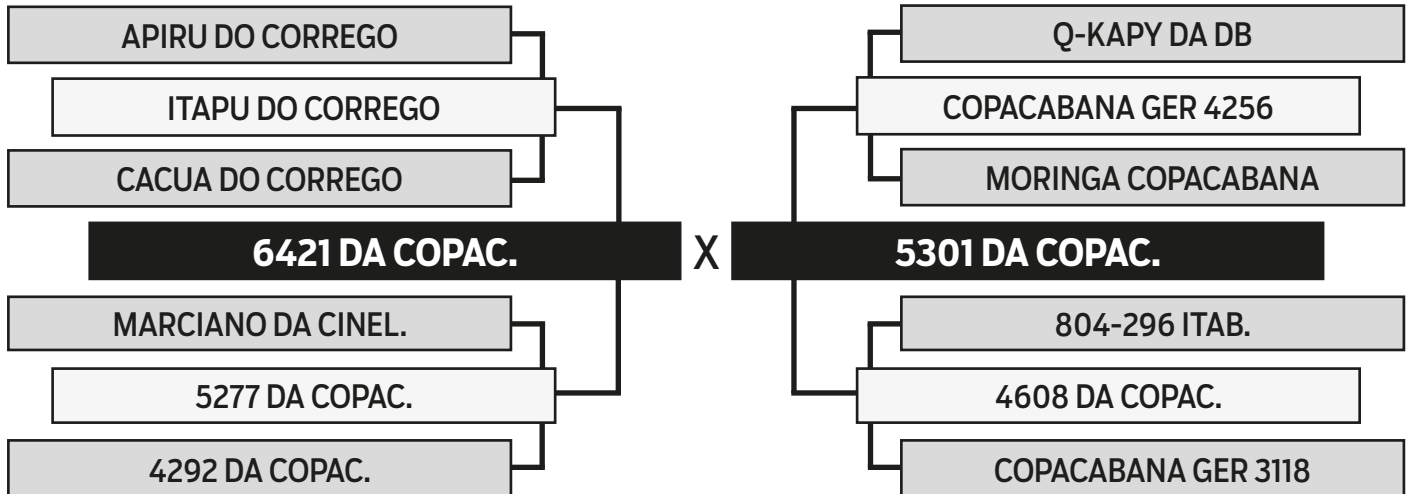

AVALIAÇÃO GENÉTICA - PMGZ



iABCZ: **18.50** - DECA: **1**

	PD-ED	PA-ED	PS-ED	PM-EM	TMD	IPP	STAY	PE-365	AOL	ACAB
DEP	9.57	10.78	7.23	1.19	5.88	-8.48	35.37	0.23	1.39	-0.49
DECA	1	1	2	2	1	2	1	2	1	8



LEILÃO TABAPUÃ COPACABANA

R\$ **450,00**
x 30 parcelas
(2+2+2+2+2+2+18)
Valor por parcela

LOTE

67

A224 DA COPAC.

SEXO: **MACHO** - RAÇA: **TABAPUÃ PO** - REG: **GER A224** - NASC.: **03/11/2020**
PESO: **503 KG** - PE: **35 CM**

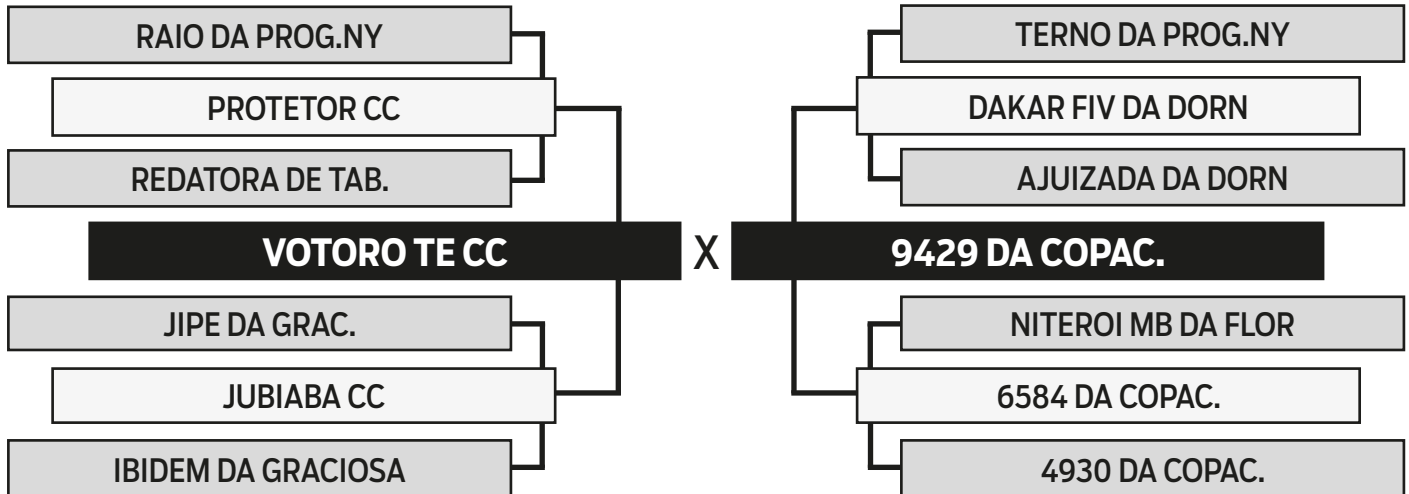

AVALIAÇÃO GENÉTICA - PMGZ



iABCZ: **6.49** - DECA: **3**

	PD-ED	PA-ED	PS-ED	PM-EM	TMD	IPP	STAY	PE-365	AOL	ACAB
DEP	6.49	7.61	7.92	0.53	3.79	-3.52	29.85	0.18	0.22	-0.03
DECA	1	1	1	4	2	4	8	2	5	6



LEILÃO TABAPUÃ COPACABANA

R\$ **400,00**
x 30 parcelas
(2+2+2+2+2+2+18)
Valor por parcela

LOTE

68

A227 DA COPAC.

SEXO: **MACHO** - RAÇA: **TABAPUÃ PO** - REG: **GER A227** - NASC.: **03/11/2020**
PESO: **490 KG** - PE: **36 CM**

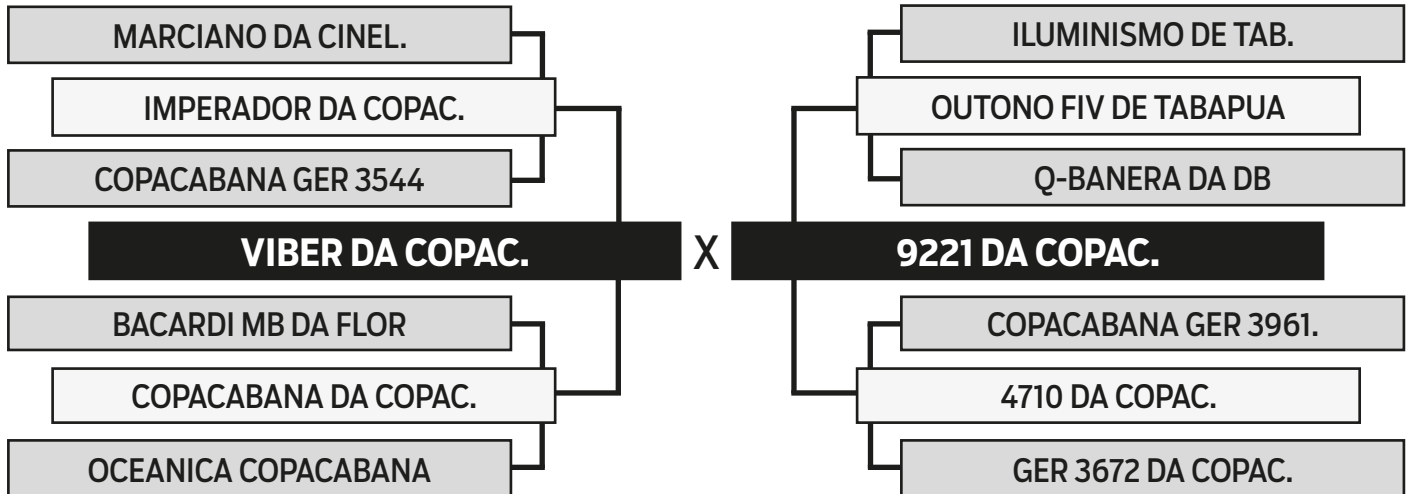

AVALIAÇÃO GENÉTICA - PMGZ



iABCZ: **7.14** - DECA: **3**

	PD-ED	PA-ED	PS-ED	PM-EM	TMD	IPP	STAY	PE-365	AOL	ACAB
DEP	1.25	3.59	5.59	1.68	2.75	-4.34	31.64	0.61	0.77	-0.38
DECA	5	3	3	1	3	4	5	1	2	7



LEILÃO TABAPUÃ COPACABANA

R\$ **450,00**
x 30 parcelas
(2+2+2+2+2+2+18)
Valor por parcela

LOTE

69

A244 DA COPAC.

SEXO: **MACHO** - RAÇA: **TABAPUÃ PO** - REG: **GER A244** - NASC.: **06/11/2020**
PESO: **435 KG** - PE: **34 CM**

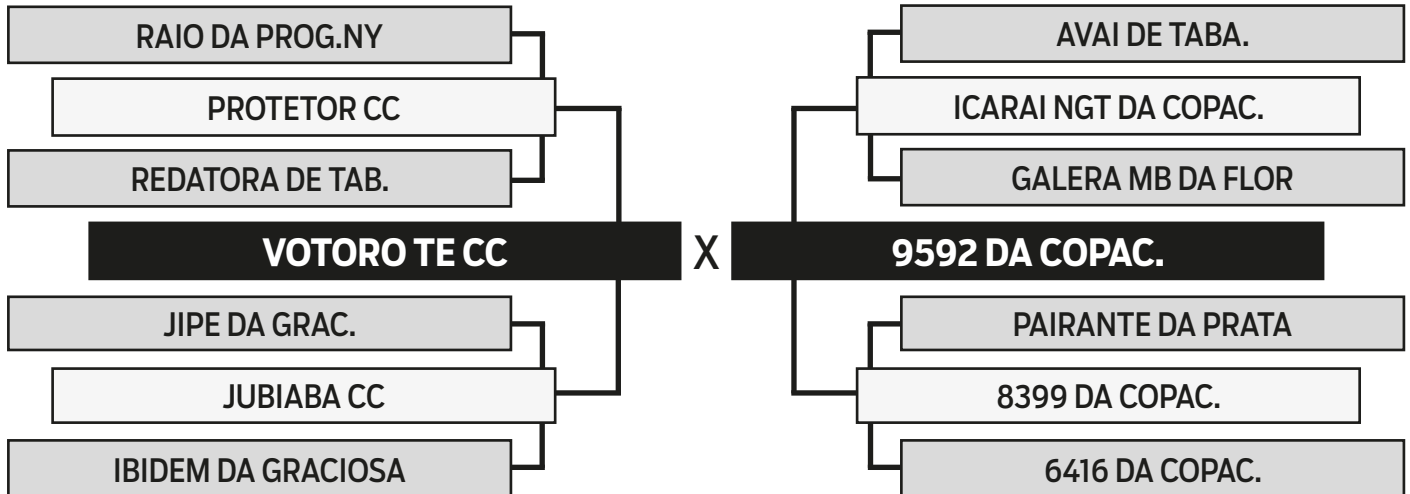

AVALIAÇÃO GENÉTICA - PMGZ



iABCZ: **0.96** - DECA: **6**

	PD-ED	PA-ED	PS-ED	PM-EM	TMD	IPP	STAY	PE-365	AOL	ACAB
DEP	2.33	2.67	2.98	0.41	0.98	-0.44	30.12	0.05	0.26	-0.40
DECA	4	4	4	5	5	6	8	5	5	8



LEILÃO TABAPUÃ COPACABANA

R\$ **400,00**
x 30 parcelas
(2+2+2+2+2+2+18)
Valor por parcela

LOTE

70

A261 DA COPAC.

SEXO: **MACHO** - RAÇA: **TABAPUÃ PO** - REG: **GER A261** - NASC.: **10/11/2020**
PESO: **440 KG** - PE: **32 CM**

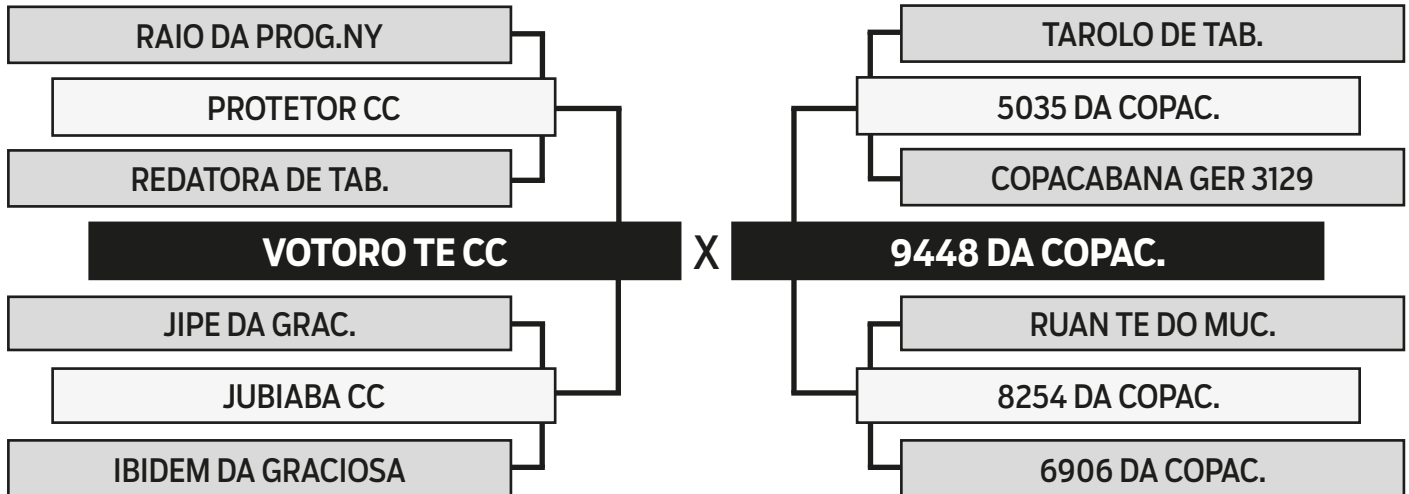

AVALIAÇÃO GENÉTICA - PMGZ



iABCZ: **-0.56** - DECA: **7**

	PD-ED	PA-ED	PS-ED	PM-EM	TMD	IPP	STAY	PE-365	AOL	ACAB
DEP	1.41	1.44	1.45	0.31	0.70	1.63	30.29	-0.02	0.40	0.08
DECA	5	5	6	5	5	7	8	6	4	5



LEILÃO TABAPUÃ COPACABANA

R\$ **400,00**
x 30 parcelas
(2+2+2+2+2+2+18)
Valor por parcela

LOTE

71

A262 DA COPAC.

SEXO: **MACHO** - RAÇA: **TABAPUÃ PO** - REG: **GER A262** - NASC.: **10/11/2020**
PESO: **685 KG** - PE: **33 CM**

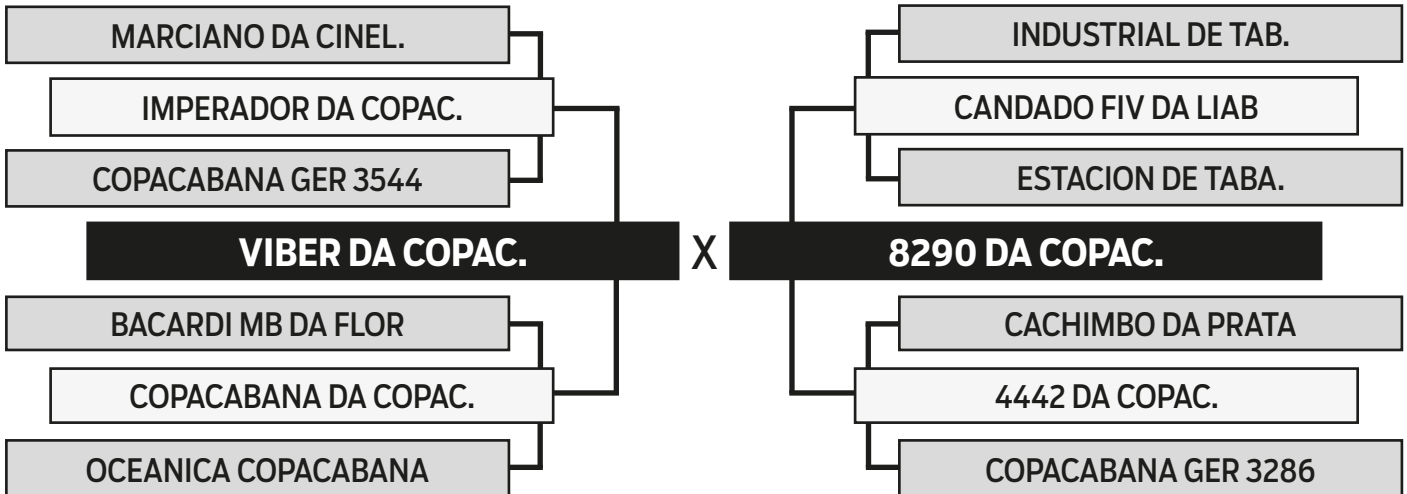

AVALIAÇÃO GENÉTICA - PMGZ



iABCZ: **18.87** - DECA: **1**

	PD-ED	PA-ED	PS-ED	PM-EM	TMD	IPP	STAY	PE-365	AOL	ACAB
DEP	7.19	10.26	16.20	1.69	6.17	-0.23	34.64	0.68	1.95	-1.51
DECA	1	1	1	1	1	6	1	1	1	10



LEILÃO TABAPUÃ COPACABANA

R\$ **450,00**
x 30 parcelas
(2+2+2+2+2+2+18)
Valor por parcela

LOTE

72

A272 DA COPAC.

SEXO: **MACHO** - RAÇA: **TABAPUÃ PO** - REG: **GER A272** - NASC.: **14/11/2020**
PESO: **510 KG** - PE: **38 CM**

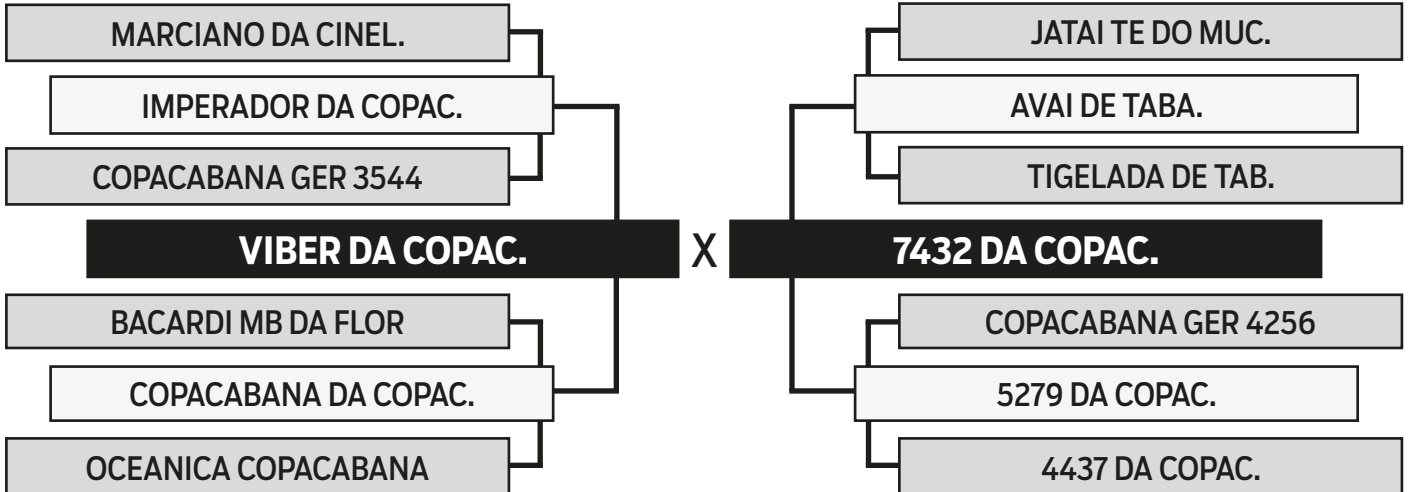

AVALIAÇÃO GENÉTICA - PMGZ



iABCZ: **19.83** - DECA: **1**

	PD-ED	PA-ED	PS-ED	PM-EM	TMD	IPP	STAY	PE-365	AOL	ACAB
DEP	5.63	10.41	15.40	3.20	7.38	-9.56	33.93	0.69	1.87	-0.35
DECA	1	1	1	1	1	2	2	1	1	7



LEILÃO TABAPUÃ COPACABANA

LOTE

73

A281 DA COPAC.

R\$ **450,00**
x 30 parcelas
(2+2+2+2+2+2+18)
Valor por parcela

SEXO: **MACHO** - RAÇA: **TABAPUÃ PO** - REG: **GER A281** - NASC.: **15/11/2020**
PESO: **545 KG** - PE: **38 CM**

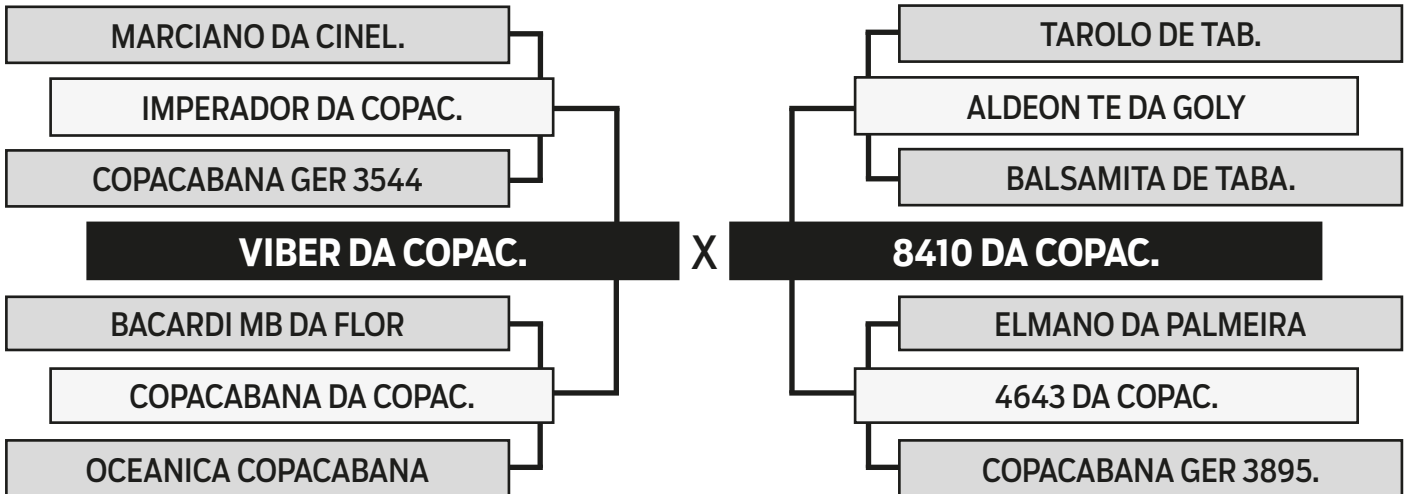

AVALIAÇÃO GENÉTICA - PMGZ



iABCZ: **15.59** - DECA: **1**

	PD-ED	PA-ED	PS-ED	PM-EM	TMD	IPP	STAY	PE-365	AOL	ACAB
DEP	8.09	8.80	11.58	1.80	6.90	-7.73	32.46	0.53	1.63	-0.45
DECA	1	1	1	1	1	2	4	1	1	8



LEILÃO TABAPUÃ COPACABANA

LOTE

74

A282 DA COPAC.

R\$ **400,00**
x 30 parcelas
(2+2+2+2+2+2+18)
Valor por parcela

SEXO: **MACHO** - RAÇA: **TABAPUÃ PO** - REG: **GER A282** - NASC.: **15/11/2020**
PESO: **505 KG** - PE: **41 CM**

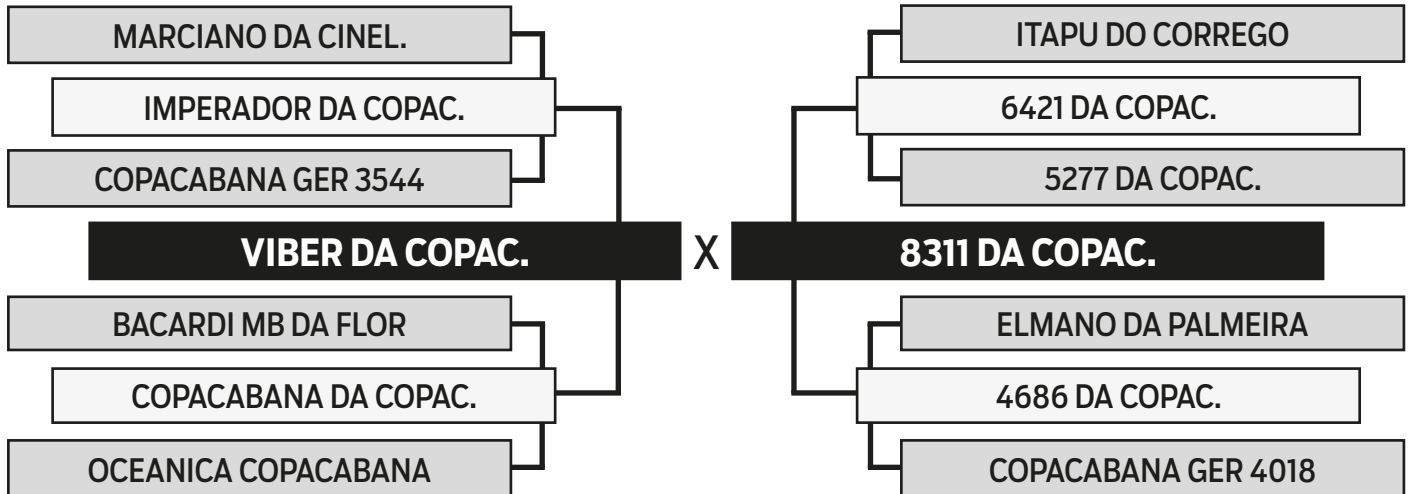

AVALIAÇÃO GENÉTICA - PMGZ



iABCZ: **18.73** - DECA: **1**

	PD-ED	PA-ED	PS-ED	PM-EM	TMD	IPP	STAY	PE-365	AOL	ACAB
DEP	6.74	10.97	13.55	1.39	5.61	-6.48	34.49	0.65	1.75	-0.23
DECA	1	1	1	2	1	3	1	1	1	7



LEILÃO TABAPUÃ COPACABANA

R\$ **450,00**
x 30 parcelas
(2+2+2+2+2+2+18)
Valor por parcela

LOTE

75

A284 DA COPAC.

SEXO: **MACHO** - RAÇA: **TABAPUÃ PO** - REG: **GER A284** - NASC.: **17/11/2020**
PESO: **510 KG** - PE: **40 CM**

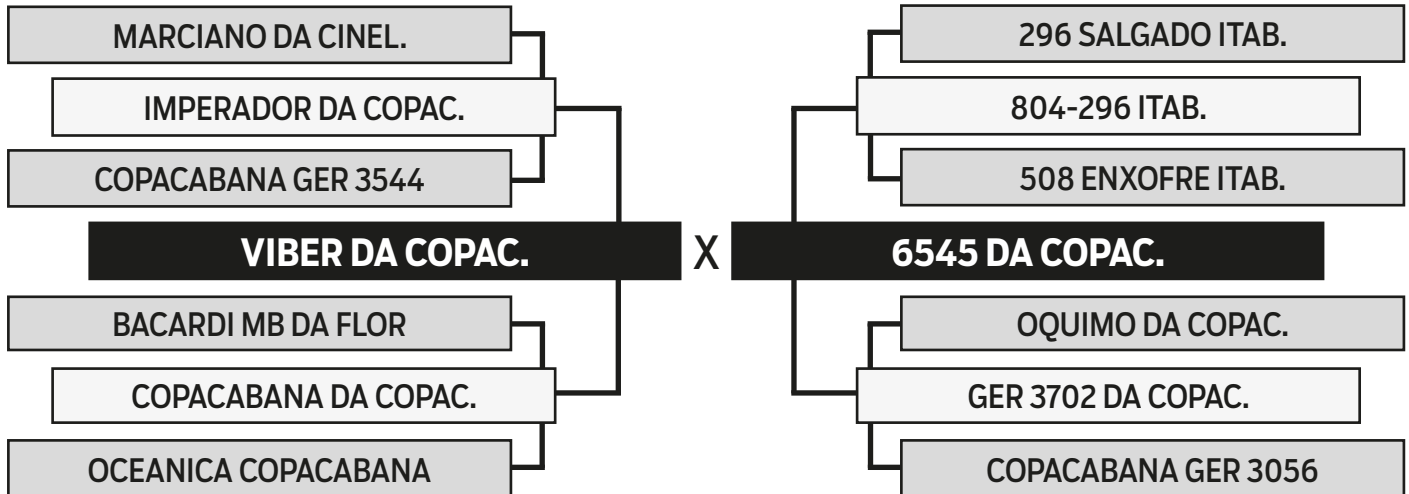

AVALIAÇÃO GENÉTICA - PMGZ



iABCZ: **13.30** - DECA: **1**

	PD-ED	PA-ED	PS-ED	PM-EM	TMD	IPP	STAY	PE-365	AOL	ACAB
DEP	4.82	6.17	9.26	2.81	6.30	0.76	33.40	0.59	2.10	-0.98
DECA	1	2	1	1	1	6	2	1	1	10



LEILÃO TABAPUÃ COPACABANA

R\$ **400,00**
x 30 parcelas
(2+2+2+2+2+2+18)
Valor por parcela

LOTE

76

A286 DA COPAC.

SEXO: **MACHO** - RAÇA: **TABAPUÃ PO** - REG: **GER A286** - NASC.: **20/11/2020**
PESO: **477 KG** - PE: **36 CM**

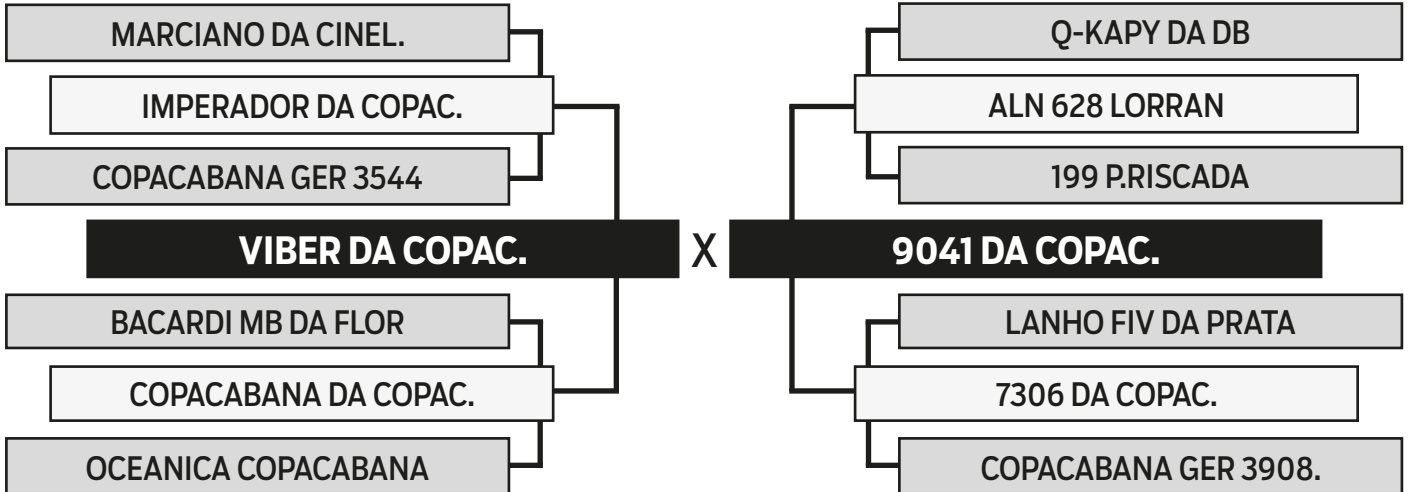

AVALIAÇÃO GENÉTICA - PMGZ



iABCZ: **16.86** - DECA: **1**

	PD-ED	PA-ED	PS-ED	PM-EM	TMD	IPP	STAY	PE-365	AOL	ACAB
DEP	4.97	7.80	12.61	2.18	5.64	-1.24	34.58	0.77	1.62	-0.75
DECA	1	1	1	1	1	5	1	1	1	9



LEILÃO TABAPUÃ COPACABANA

R\$ **400,00**
x 30 parcelas
(2+2+2+2+2+2+18)
Valor por parcela

LOTE

77

A300 DA COPAC.

SEXO: **MACHO** - RAÇA: **TABAPUÃ PO** - REG: **GER A300** - NASC.: **20/12/2020**
PESO: **488 KG** - PE: **33 CM**

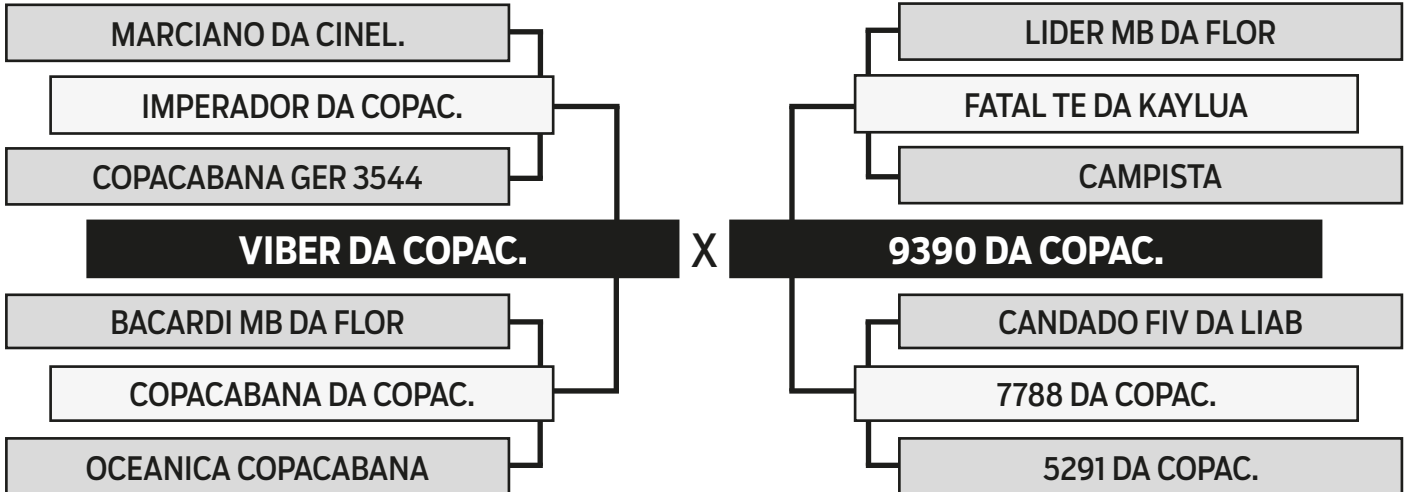

AVALIAÇÃO GENÉTICA - PMGZ



iABCZ: **15.88** - DECA: **1**

	PD-ED	PA-ED	PS-ED	PM-EM	TMD	IPP	STAY	PE-365	AOL	ACAB
DEP	8.03	9.83	14.43	0.81	5.49	-5.51	32.60	0.65	1.64	-0.45
DECA	1	1	1	3	1	3	4	1	1	8



LEILÃO TABAPUÃ COPACABANA

R\$ **450,00**
x 30 parcelas
(2+2+2+2+2+2+18)
Valor por parcela

LOTE

78

A382 DA COPAC.

SEXO: **MACHO** - RAÇA: **TABAPUÃ PO** - REG: **GER A382** - NASC.: **27/02/2021**
PESO: **510 KG** - PE: **36 CM**

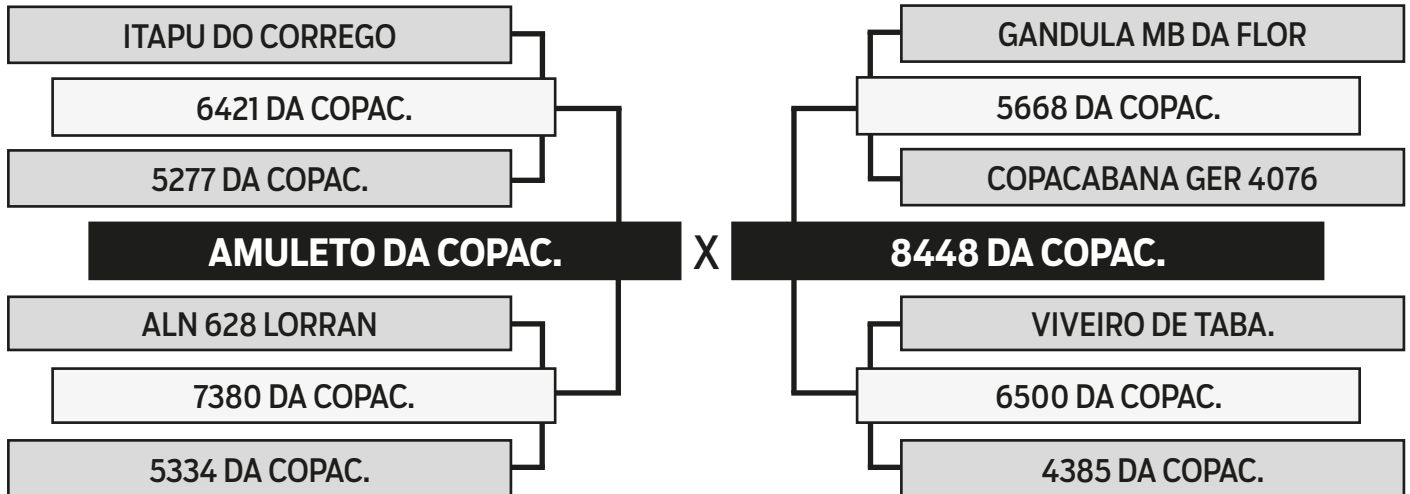

AVALIAÇÃO GENÉTICA - PMGZ



iABCZ: **19.23** - DECA: **1**

	PD-ED	PA-ED	PS-ED	PM-EM	TMD	IPP	STAY	PE-365	AOL	ACAB
DEP	7.91	11.66	13.83	1.08	5.78	-6.90	35.10	0.27	1.94	0.47
DECA	1	1	1	3	1	3	1	1	1	3



LEILÃO TABAPUÃ COPACABANA

R\$ **450,00**
x 30 parcelas
(2+2+2+2+2+2+18)
Valor por parcela

LOTE

79

A178 DA COPAC.

SEXO: **MACHO** - RAÇA: **TABAPUÃ PO** - REG: **GER A178** - NASC.: **03/10/2020**
PESO: **495 KG** - PE: **42 CM**

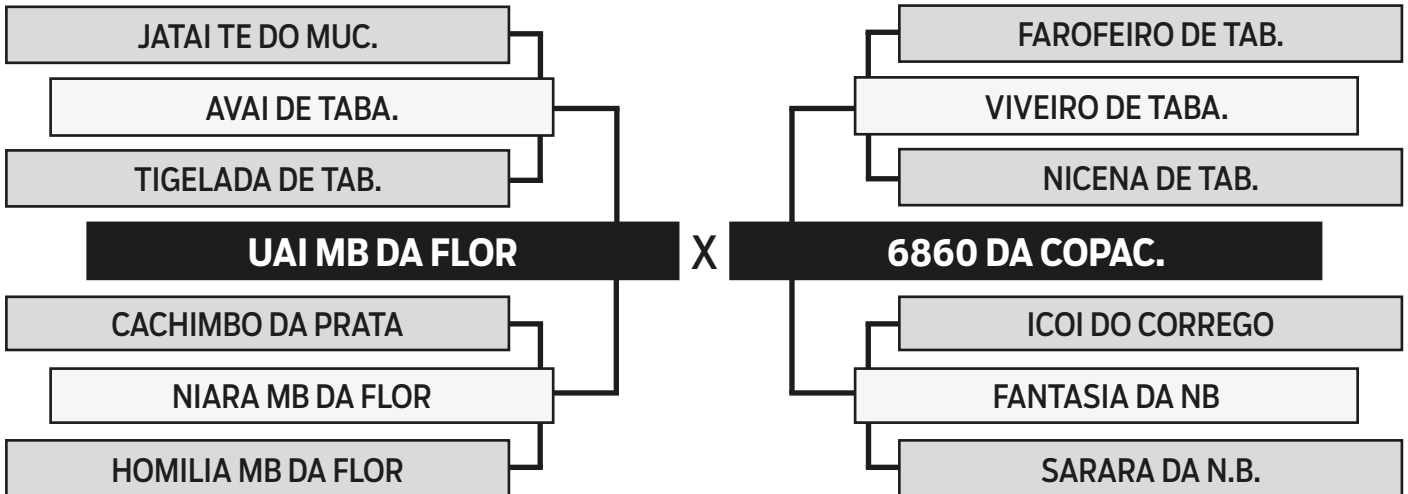

AVALIAÇÃO GENÉTICA - PMGZ



iABCZ: **7.98** - DECA: **2**

	PD-ED	PA-ED	PS-ED	PM-EM	TMD	IPP	STAY	PE-365	AOL	ACAB
DEP	1.62	3.75	6.47	1.76	2.98	-4.72	31.97	0.52	1.27	-0.56
DECA	5	3	2	1	2	3	5	1	1	8



LEILÃO TABAPUÃ COPACABANA

R\$ **450,00**
x 30 parcelas
(2+2+2+2+2+2+18)
Valor por parcela

LOTE

80

A184 DA COPAC.

SEXO: **MACHO** - RAÇA: **TABAPUÃ PO** - REG: **GER A184** - NASC.: **04/10/2020**
PESO: **553 KG** - PE: **36 CM**

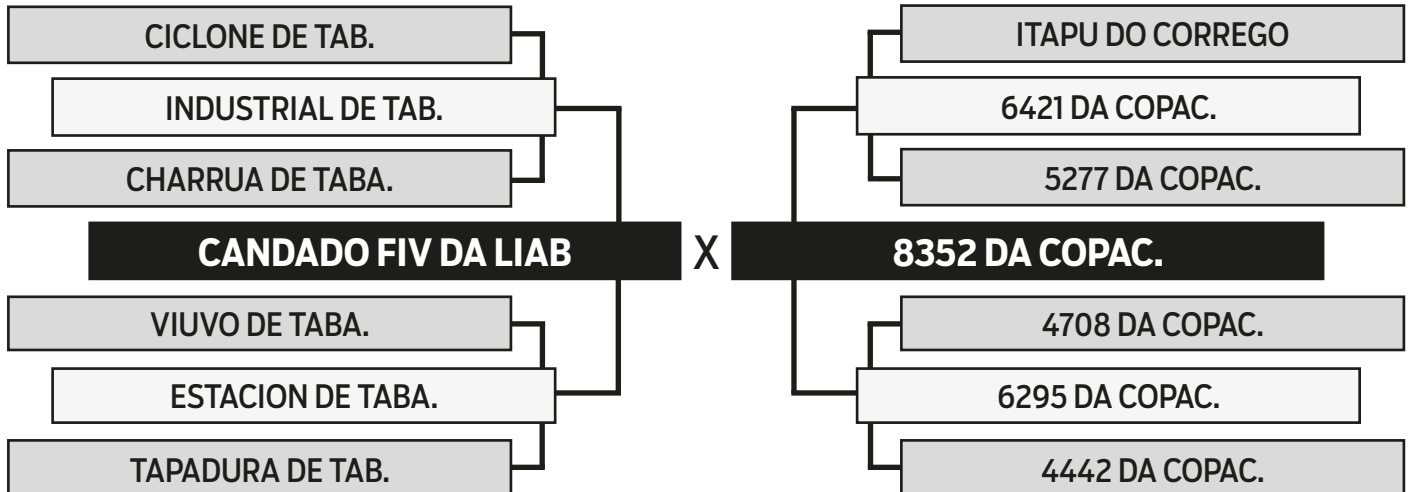

AVALIAÇÃO GENÉTICA - PMGZ



iABCZ: **17.35** - DECA: **1**

	PD-ED	PA-ED	PS-ED	PM-EM	TMD	IPP	STAY	PE-365	AOL	ACAB
DEP	6.74	9.03	11.86	-1.07	2.29	-1.95	37.03	0.17	1.41	-1.32
DECA	1	1	1	9	3	5	1	3	1	10



LEILÃO TABAPUÃ COPACABANA

LOTE

81

A379 DA COPAC.

R\$ **400,00**
x 30 parcelas
(2+2+2+2+2+2+18)
Valor por parcela

SEXO: **MACHO** - RAÇA: **TABAPUÃ PO** - REG: **GER A379** - NASC.: **24/02/2021**
PESO: **470 KG** - PE: **35 CM**

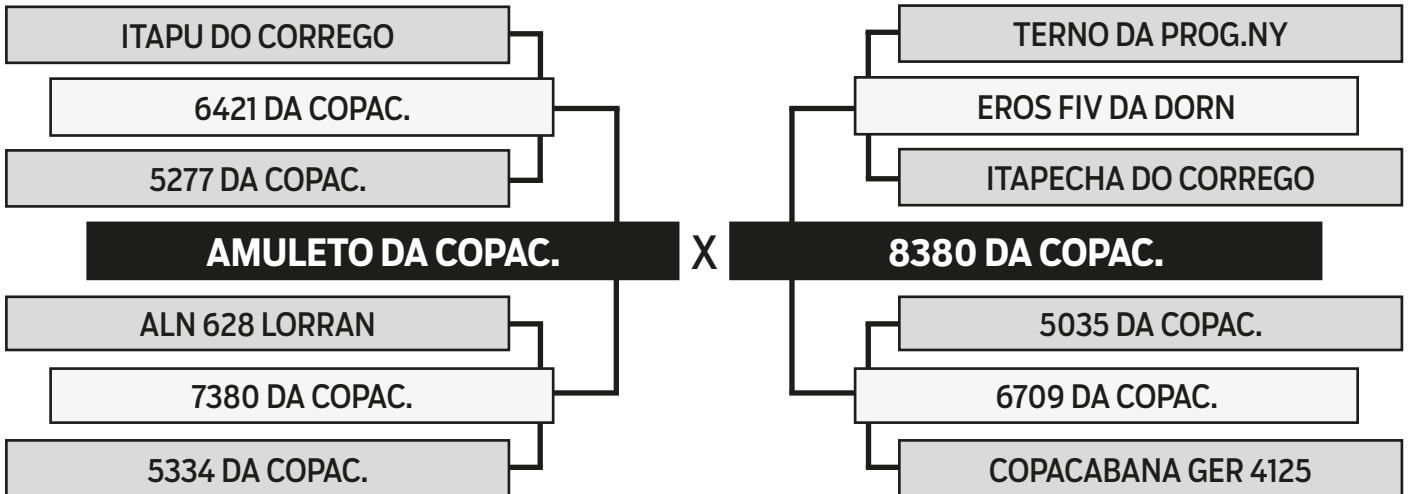

AVALIAÇÃO GENÉTICA - PMGZ



iABCZ: **18.56** - DECA: **1**

	PD-ED	PA-ED	PS-ED	PM-EM	TMD	IPP	STAY	PE-365	AOL	ACAB
DEP	7.66	11.15	11.26	1.32	6.12	-6.42	35.30	0.21	2.13	0.45
DECA	1	1	1	2	1	3	1	2	1	3



LEILÃO TABAPUÃ COPACABANA

LOTE

82

A390 DA COPAC.

R\$ **400,00**
x 30 parcelas
(2+2+2+2+2+2+18)
Valor por parcela

SEXO: **MACHO** - RAÇA: **TABAPUÃ PO** - REG: **GER A390** - NASC.: **05/03/2021**
PESO: **465 KG** - PE: **35 CM**

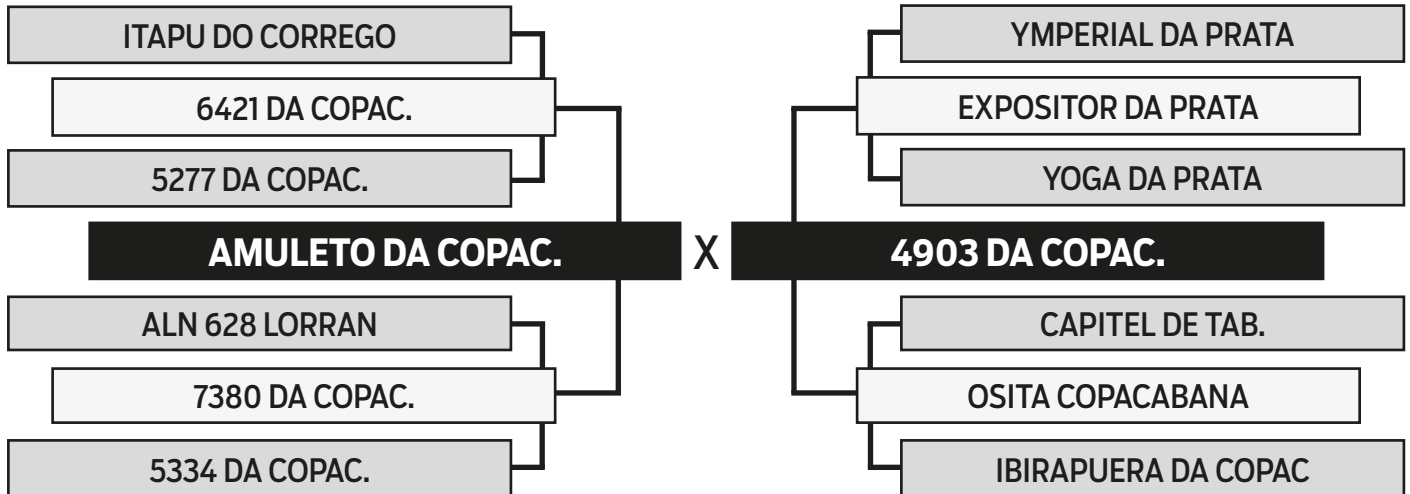

AVALIAÇÃO GENÉTICA - PMGZ



iABCZ: **19.20** - DECA: **1**

	PD-ED	PA-ED	PS-ED	PM-EM	TMD	IPP	STAY	PE-365	AOL	ACAB
DEP	7.56	9.78	9.31	2.01	6.49	-12.59	35.01	0.35	0.72	-0.45
DECA	1	1	1	1	1	1	1	1	2	8



LEILÃO TABAPUÃ COPACABANA

R\$ **450,00**
x 30 parcelas
(2+2+2+2+2+2+18)
Valor por parcela

LOTE

83

A402 DA COPAC.

SEXO: **MACHO** - RAÇA: **TABAPUÃ PO** - REG: **GER A402** - NASC.: **01/04/2021**
PESO: **470 KG** - PE: **35 CM**

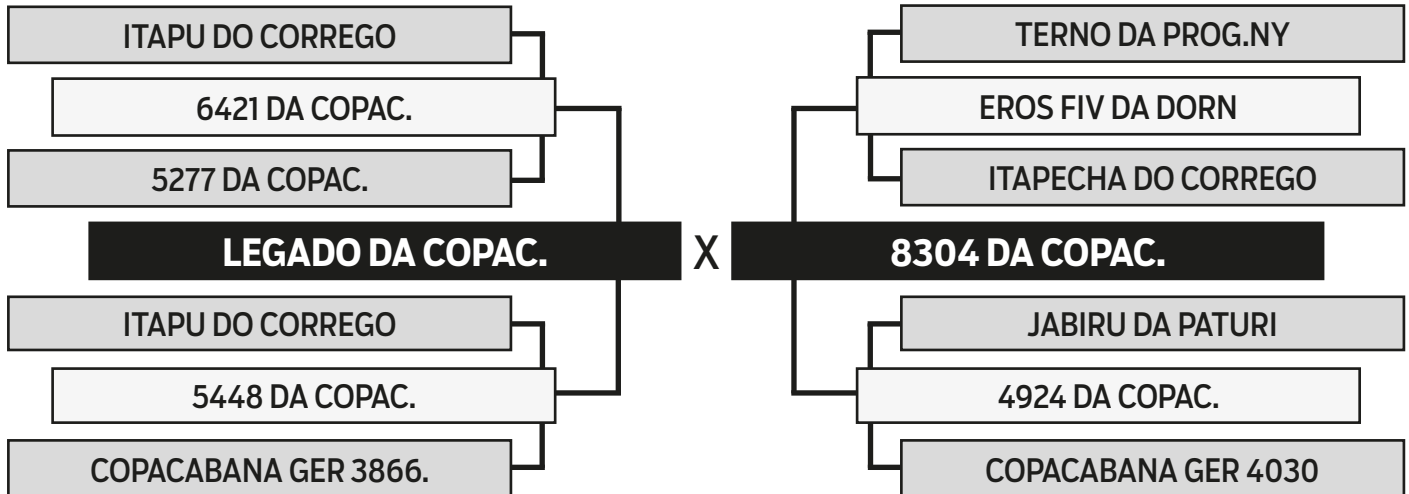

AVALIAÇÃO GENÉTICA - PMGZ



iABCZ: **13.14** - DECA: **1**

	PD-ED	PA-ED	PS-ED	PM-EM	TMD	IPP	STAY	PE-365	AOL	ACAB
DEP	7.70	9.11	9.93	-0.03	4.06	-1.26	33.44	0.35	2.11	0.78
DECA	1	1	1	6	1	5	2	1	1	2



LEILÃO TABAPUÃ COPACABANA

R\$ **450,00**
x 30 parcelas
(2+2+2+2+2+2+18)
Valor por parcela

LOTE

84

A411 DA COPAC.

SEXO: **MACHO** - RAÇA: **TABAPUÃ PO** - REG: **GER A411** - NASC.: **24/04/2021**
PESO: **457 KG** - PE: **35 CM**

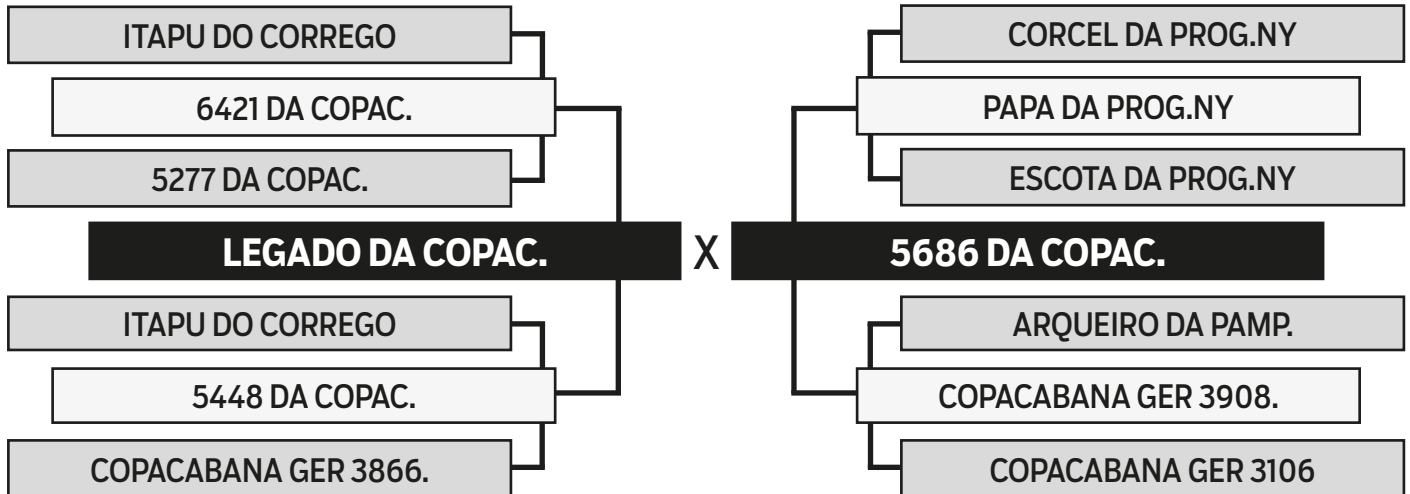

AVALIAÇÃO GENÉTICA - PMGZ



iABCZ: **9.25** - DECA: **2**

	PD-ED	PA-ED	PS-ED	PM-EM	TMD	IPP	STAY	PE-365	AOL	ACAB
DEP	3.01	3.16	4.52	-0.45	0.53	-4.27	34.53	0.28	0.85	0.55
DECA	3	4	3	7	6	4	1	1	2	3



LEILÃO TABAPUÃ COPACABANA

R\$ **400,00**
x 30 parcelas
(2+2+2+2+2+2+18)
Valor por parcela

LOTE

85

A441 DA COPAC.

SEXO: **MACHO** - RAÇA: **TABAPUÃ PO** - REG: **GER A441** - NASC.: **04/08/2021**
PESO: **505 KG** - PE: **36 CM**

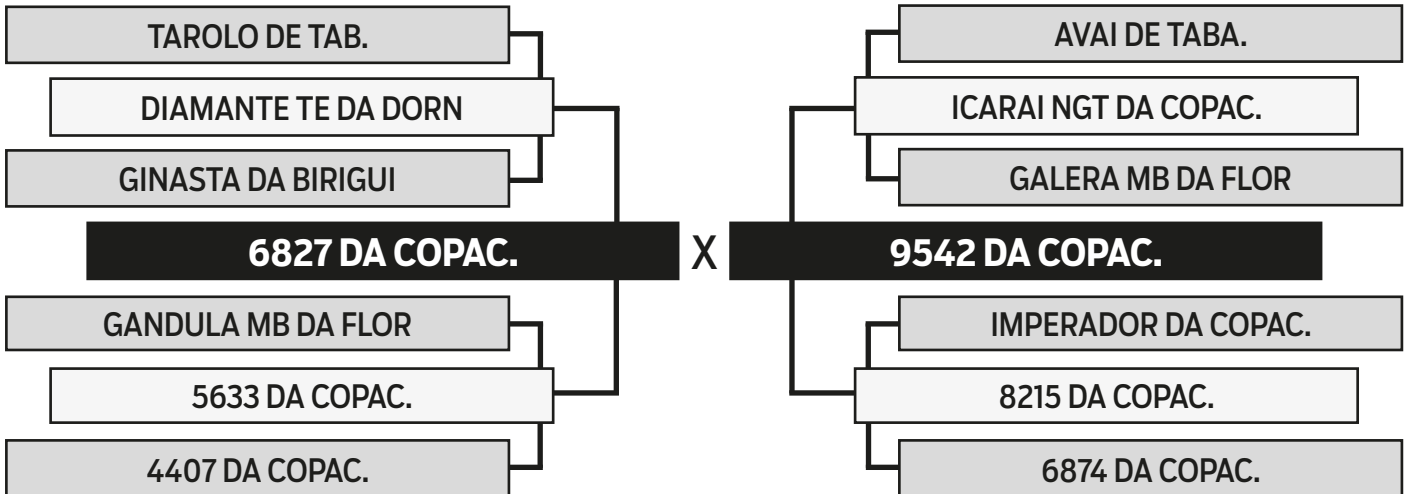

AVALIAÇÃO GENÉTICA - PMGZ



iABCZ: **10.27** - DECA: **2**

	PD-ED	PA-ED	PS-ED	PM-EM	TMD	IPP	STAY	PE-365	AOL	ACAB
DEP	4.54	8.68	10.87	2.19	5.59	2.00	32.12	0.12	0.87	0.30
DECA	2	1	1	1	1	7	4	3	2	4



LEILÃO TABAPUÃ COPACABANA

R\$ **470,00**
x 30 parcelas
(2+2+2+2+2+2+18)
Valor por parcela

LOTE

86

A210 DA COPAC.

SEXO: **MACHO** - RAÇA: **TABAPUÃ PO** - REG: **GER A210** - NASC.: **30/10/2020**
PESO: **540 KG** - PE: **39 CM**

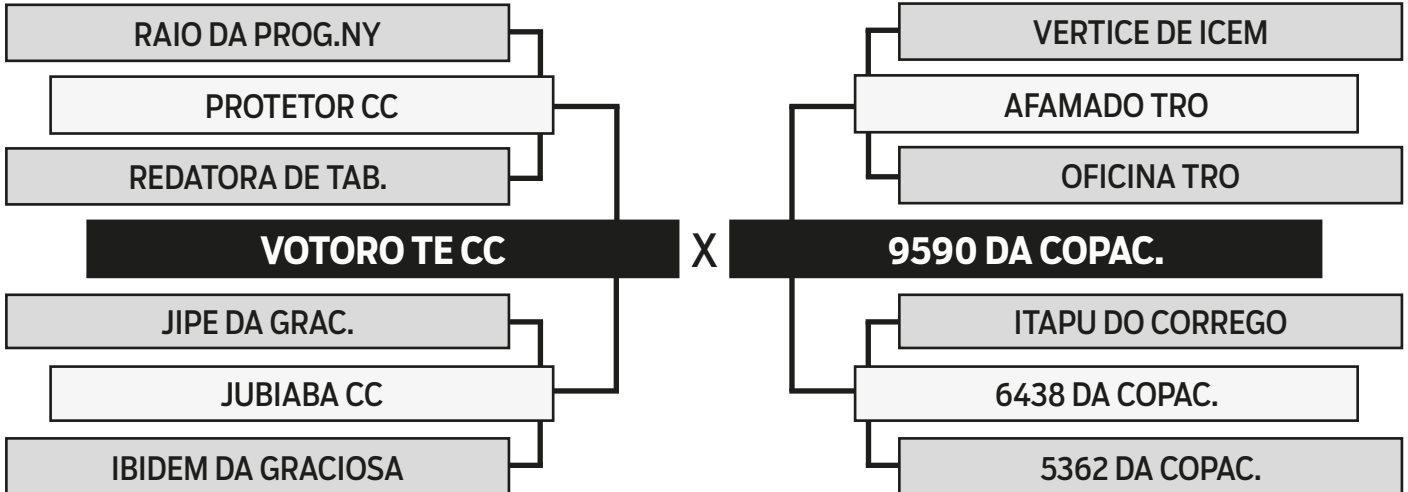

AVALIAÇÃO GENÉTICA - PMGZ



iABCZ: **6.30** - DECA: **3**

	PD-ED	PA-ED	PS-ED	PM-EM	TMD	IPP	STAY	PE-365	AOL	ACAB
DEP	4.20	5.36	6.29	0.45	2.27	-4.85	30.85	0.32	0.10	-0.37
DECA	2	2	2	4	3	3	7	1	6	7



LEILÃO TABAPUÃ COPACABANA

R\$ **470,00**
x 30 parcelas
(2+2+2+2+2+2+18)
Valor por parcela

LOTE

87

A220 DA COPAC.

SEXO: **MACHO** - RAÇA: **TABAPUÃ PO** - REG: **GER A220** - NASC.: **03/11/2020**
PESO: **570 KG** - PE: **37 CM**

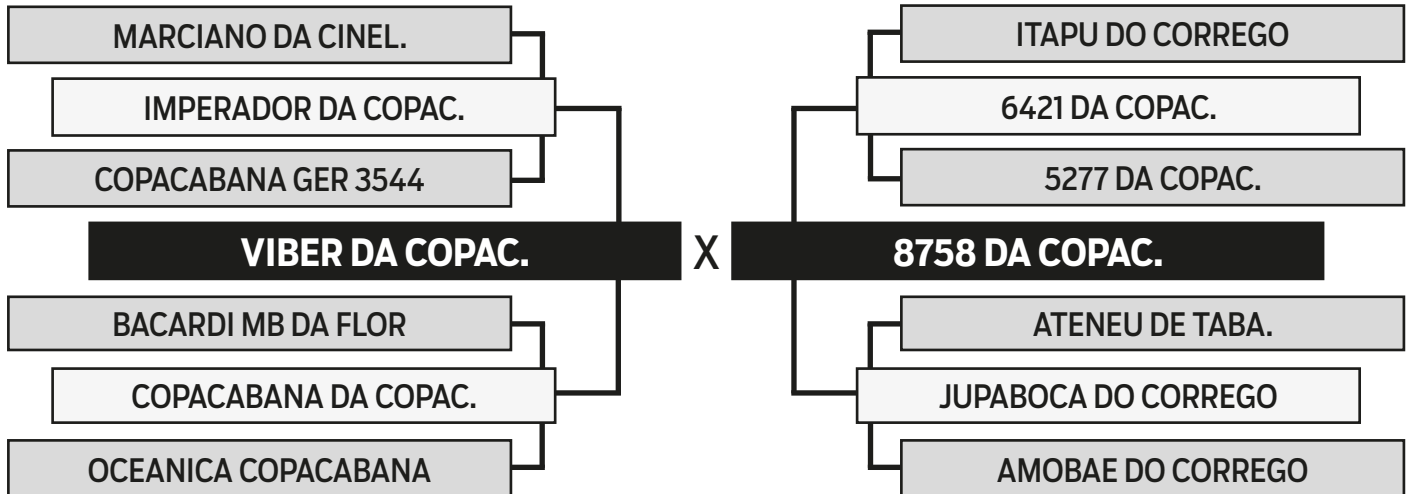

AVALIAÇÃO GENÉTICA - PMGZ



iABCZ: **21.18** - DECA: **1**

	PD-ED	PA-ED	PS-ED	PM-EM	TMD	IPP	STAY	PE-365	AOL	ACAB
DEP	8.53	11.84	17.23	1.34	6.24	-11.83	34.06	0.66	1.87	-1.09
DECA	1	1	1	2	1	1	2	1	1	10



LEILÃO TABAPUÃ COPACABANA

R\$ **450,00**
x 30 parcelas
(2+2+2+2+2+2+18)
Valor por parcela

LOTE

88

A231 DA COPAC.

SEXO: **MACHO** - RAÇA: **TABAPUÃ PO** - REG: **GER A231** - NASC.: **03/11/2020**
PESO: **477 KG** - PE: **34 CM**

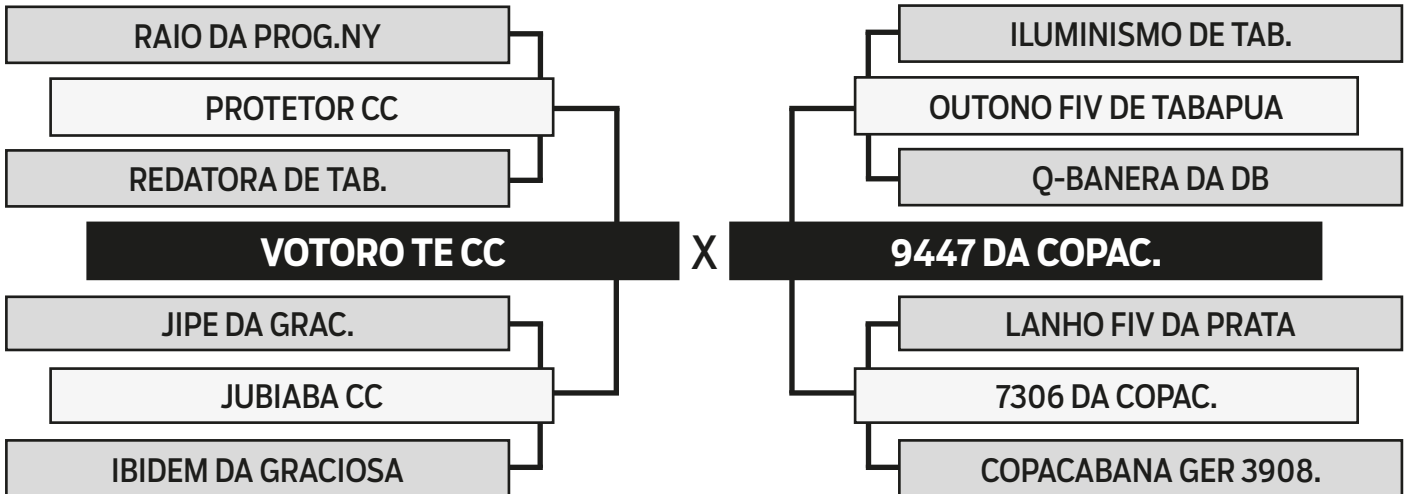

AVALIAÇÃO GENÉTICA - PMGZ



iABCZ: **0.85** - DECA: **6**

	PD-ED	PA-ED	PS-ED	PM-EM	TMD	IPP	STAY	PE-365	AOL	ACAB
DEP	2.24	2.15	3.83	-0.12	0.35	-0.66	30.25	0.05	-0.13	-0.21
DECA	4	5	4	6	6	5	8	5	7	7



LEILÃO TABAPUÃ COPACABANA

R\$ **450,00**
x 30 parcelas
(2+2+2+2+2+2+18)
Valor por parcela

LOTE

89

A241 DA COPAC.

SEXO: **MACHO** - RAÇA: **TABAPUÃ PO** - REG: **GER A241** - NASC.: **06/11/2020**
PESO: **580 KG** - PE: **38 CM**

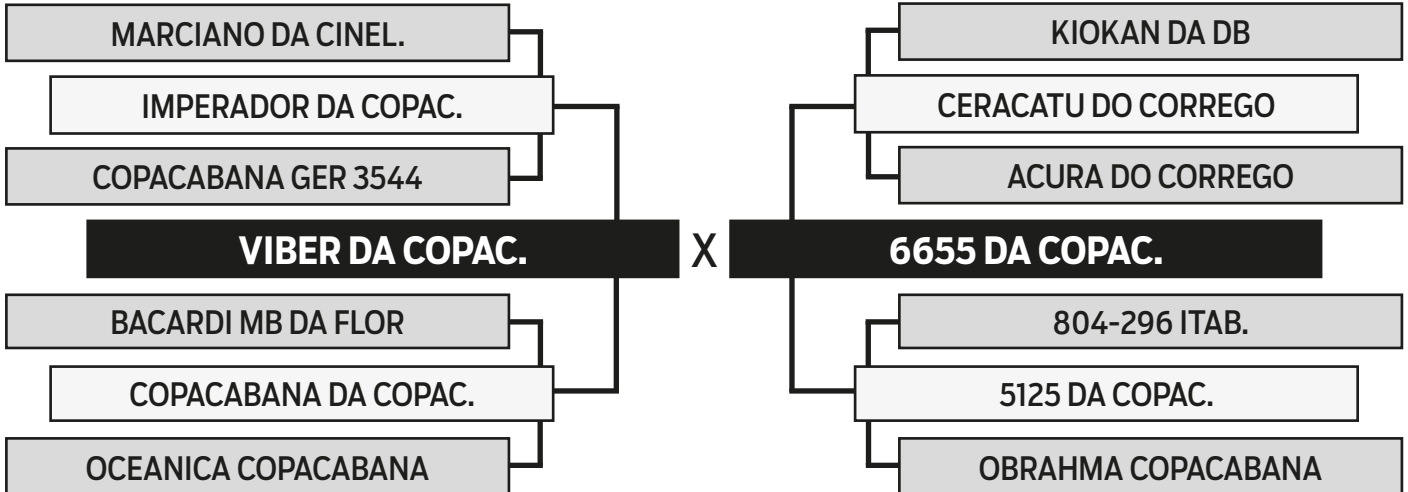

AVALIAÇÃO GENÉTICA - PMGZ



iABCZ: **10.61** - DECA: **1**

	PD-ED	PA-ED	PS-ED	PM-EM	TMD	IPP	STAY	PE-365	AOL	ACAB
DEP	3.11	6.43	8.23	0.68	2.61	-3.51	33.12	0.53	1.71	-0.21
DECA	3	1	1	4	3	4	3	1	1	7



LEILÃO TABAPUÃ COPACABANA

R\$ **450,00**
x 30 parcelas
(2+2+2+2+2+2+18)
Valor por parcela

LOTE

90

A242 DA COPAC.

SEXO: **MACHO** - RAÇA: **TABAPUÃ PO** - REG: **GER A242** - NASC.: **06/11/2020**
PESO: **541 KG** - PE: **38 CM**

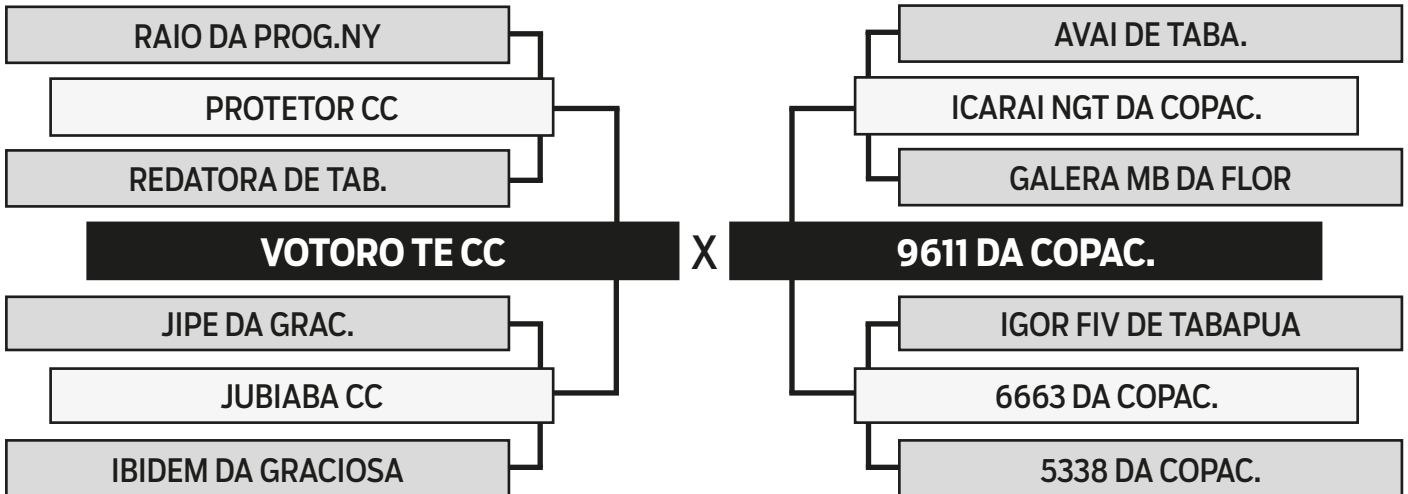

AVALIAÇÃO GENÉTICA - PMGZ



iABCZ: **3.50** - DECA: **4**

	PD-ED	PA-ED	PS-ED	PM-EM	TMD	IPP	STAY	PE-365	AOL	ACAB
DEP	3.86	4.36	5.39	0.93	2.84	-0.10	30.18	0.08	0.02	-0.17
DECA	2	3	3	3	2	6	8	4	6	6



LEILÃO TABAPUÃ COPACABANA

R\$ **450,00**
x 30 parcelas
(2+2+2+2+2+2+18)
Valor por parcela

LOTE

91

A273 DA COPAC.

SEXO: **MACHO** - RAÇA: **TABAPUÃ PO** - REG: **GER A273** - NASC.: **14/11/2020**
PESO: **582 KG** - PE: **38 CM**

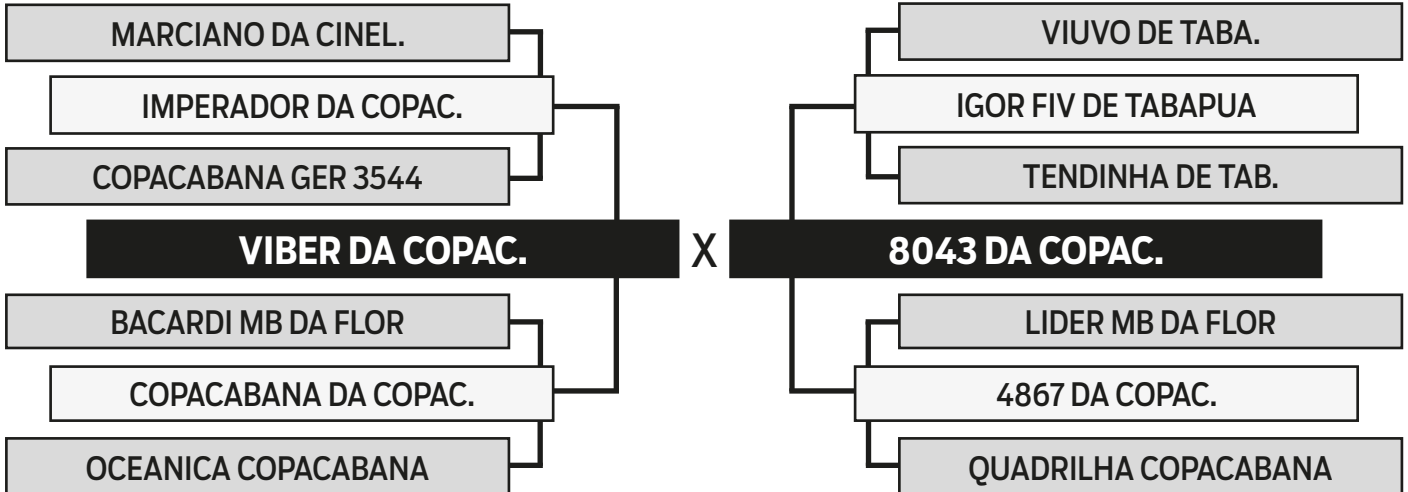

AVALIAÇÃO GENÉTICA - PMGZ



iABCZ: **17.60** - DECA: **1**

	PD-ED	PA-ED	PS-ED	PM-EM	TMD	IPP	STAY	PE-365	AOL	ACAB
DEP	8.67	11.70	14.25	2.88	8.70	-5.52	31.99	0.71	0.88	-0.20
DECA	1	1	1	1	1	3	5	1	2	7



LEILÃO TABAPUÃ COPACABANA

R\$ **450,00**
x 30 parcelas
(2+2+2+2+2+2+18)
Valor por parcela

LOTE

92

A271 DA COPAC.

SEXO: **MACHO** - RAÇA: **TABAPUÃ PO** - REG: **GER A271** - NASC.: **14/11/2020**
PESO: **560 KG** - PE: **37 CM**

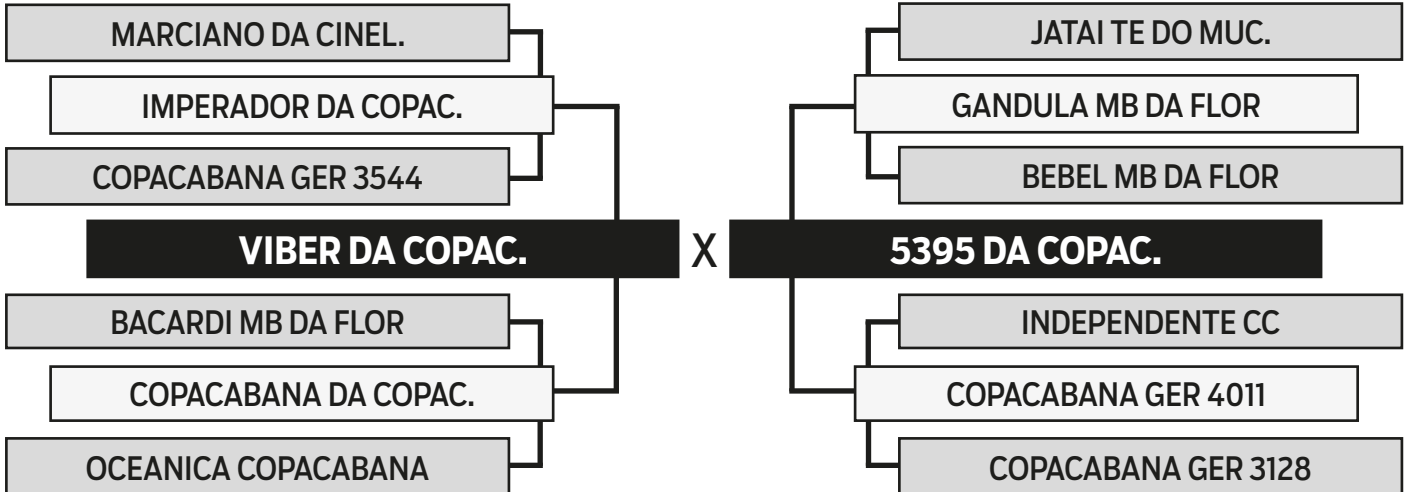

AVALIAÇÃO GENÉTICA - PMGZ



iABCZ: **15.67** - DECA: **1**

	PD-ED	PA-ED	PS-ED	PM-EM	TMD	IPP	STAY	PE-365	AOL	ACAB
DEP	7.03	9.71	14.99	2.79	7.55	1.70	32.67	0.60	1.35	0.01
DECA	1	1	1	1	1	7	4	1	1	5



LEILÃO TABAPUÃ COPACABANA

LOTE

100

A152 DA COPAC.

R\$ **350,00**
x 30 parcelas
(2+2+2+2+2+2+18)
Valor por parcela

SEXO: FÊMEA - RAÇA: TABAPUÃ PO - REG: GER A152 - NASC.: 21/09/2020
PESO: 442 KG

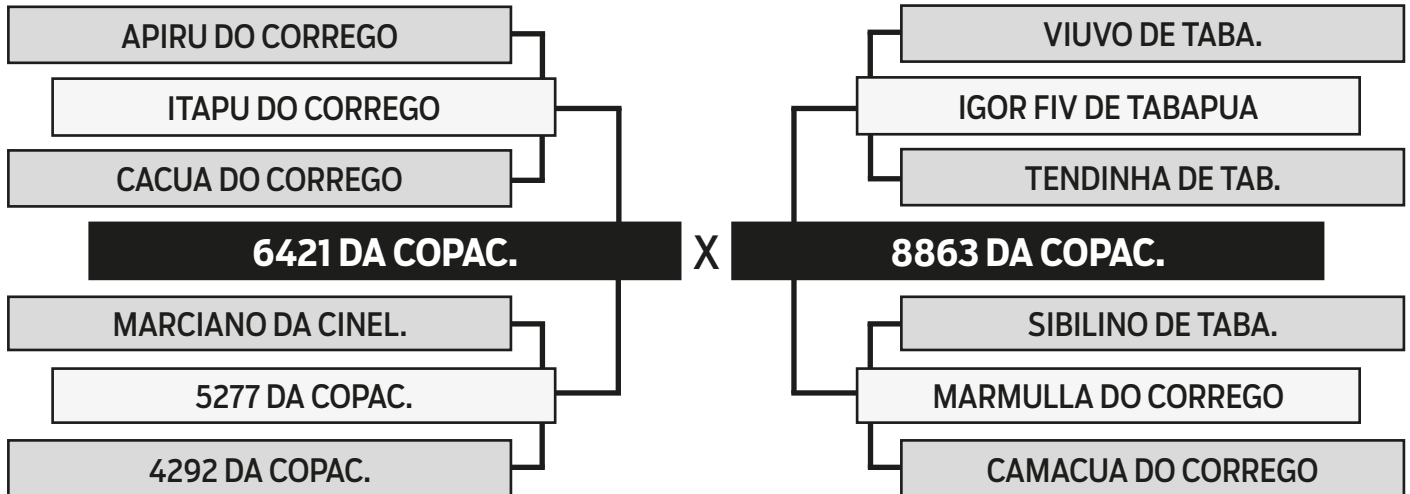

AVALIAÇÃO GENÉTICA - PMGZ



iABCZ: **14.38** - DECA: **1**

	PD-ED	PA-ED	PS-ED	PM-EM	TMD	IPP	STAY	PE-365	AOL	ACAB
DEP	8.11	9.78	10.87	0.24	4.31	-11.65	32.66	0.23	1.40	-0.15
DECA	1	1	1	5	1	1	4	2	1	6

PRENHE DO 6827 DA COPAC
PREVISÃO DE PARTO ENTRE 22/09/2023 E 01/11/2023



LEILÃO TABAPUÃ COPACABANA

LOTE

101

A155 DA COPAC.

R\$ **350,00**
x 30 parcelas
(2+2+2+2+2+2+18)
Valor por parcela

SEXO: FÊMEA - RAÇA: TABAPUÃ PO - REG: GER A155 - NASC.: 25/09/2020
PESO: 460 KG

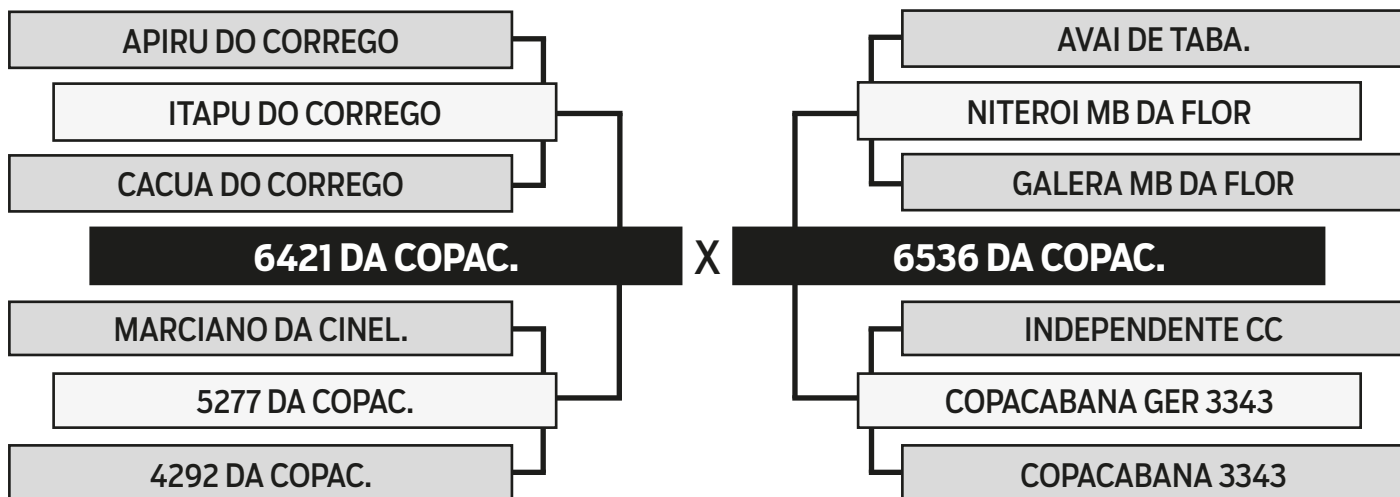

AVALIAÇÃO GENÉTICA - PMGZ



iABCZ: **17.86** - DECA: **1**

	PD-ED	PA-ED	PS-ED	PM-EM	TMD	IPP	STAY	PE-365	AOL	ACAB
DEP	8.54	11.02	11.00	0.93	5.73	-6.05	35.03	0.15	1.38	0.28
DECA	1	1	1	3	1	3	1	3	1	4

PRENHE DO 6827 DA COPAC.
PREVISÃO DE PARTO ENTRE 22/09/2023 E 01/11/2023



LEILÃO TABAPUÃ COPACABANA

LOTE

102

A157 DA COPAC.

R\$ **400,00**
x 30 parcelas
(2+2+2+2+2+2+18)
Valor por parcela

SEXO: FÊMEA - RAÇA: TABAPUÃ PO - REG: GER A157 - NASC.: 25/09/2020
PESO: 495 KG

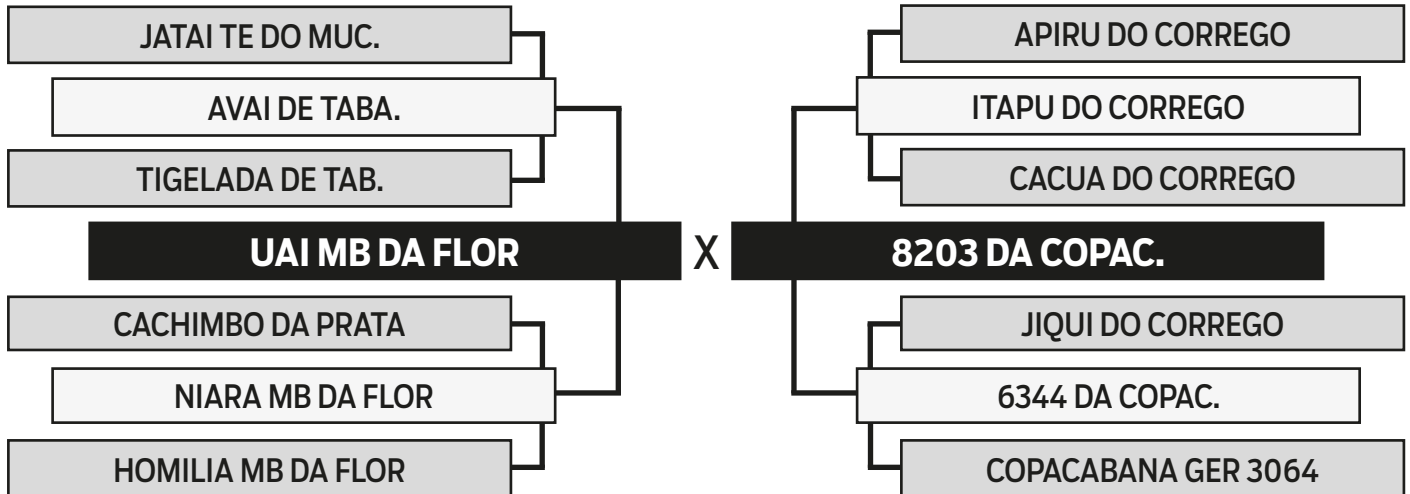

AVALIAÇÃO GENÉTICA - PMGZ



iABCZ: **7.46** - DECA: **2**

	PD-ED	PA-ED	PS-ED	PM-EM	TMD	IPP	STAY	PE-365	AOL	ACAB
DEP	3.01	5.25	8.65	2.95	5.25	3.88	31.07	0.44	1.35	-0.07
DECA	3	2	1	1	1	8	6	1	1	6

PRENHE DO AMULETO DA COPAC.
PREVISÃO DE PARTO ENTRE 22/09/2023 E 01/11/2023



LEILÃO TABAPUÃ COPACABANA

LOTE

103

A168 DA COPAC.

R\$ **350,00**
x 30 parcelas
(2+2+2+2+2+2+18)
Valor por parcela

SEXO: FÊMEA - RAÇA: TABAPUÃ PO - REG: GER A168 - NASC.: 29/09/2020
PESO: 410 KG

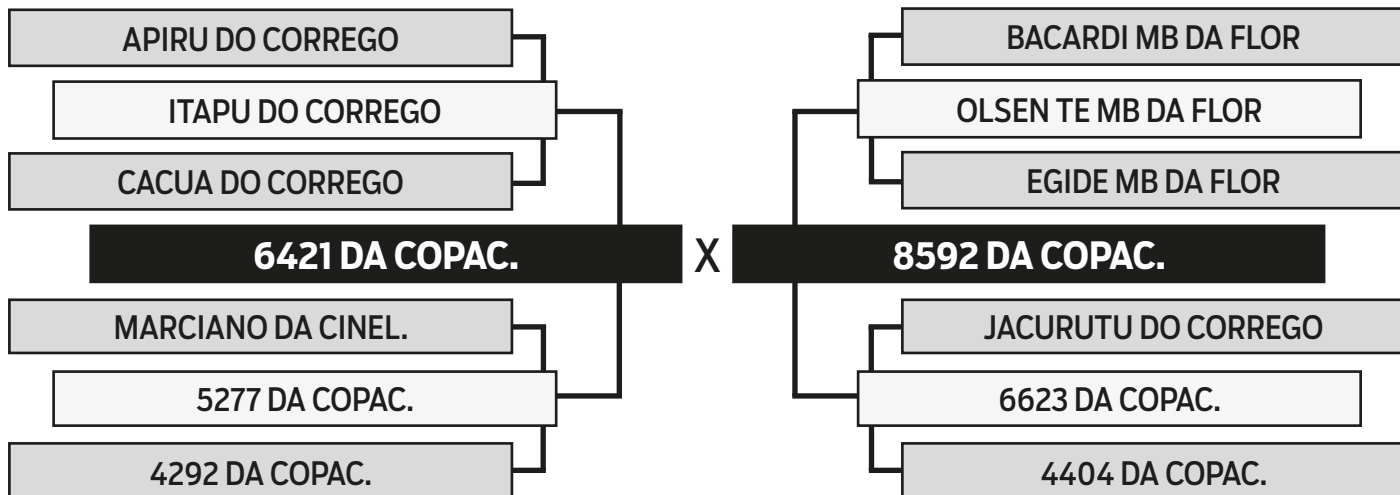

AVALIAÇÃO GENÉTICA - PMGZ



iABCZ: **19.19** - DECA: **1**

	PD-ED	PA-ED	PS-ED	PM-EM	TMD	IPP	STAY	PE-365	AOL	ACAB
DEP	8.01	12.18	13.91	1.51	5.86	-4.77	35.54	0.02	1.94	-0.55
DECA	1	1	1	2	1	3	1	5	1	8

PRENHE DO 6827 DA COPAC.
PREVISÃO DE PARTO ENTRE 22/09/2023 E 01/11/2023



LEILÃO TABAPUÃ COPACABANA

LOTE

104

A169 DA COPAC.

R\$ **400,00**
x 30 parcelas
(2+2+2+2+2+2+18)
Valor por parcela

SEXO: FÊMEA - RAÇA: TABAPUÃ PO - REG: GER A169 - NASC.: 29/09/2020
PESO: 430 KG

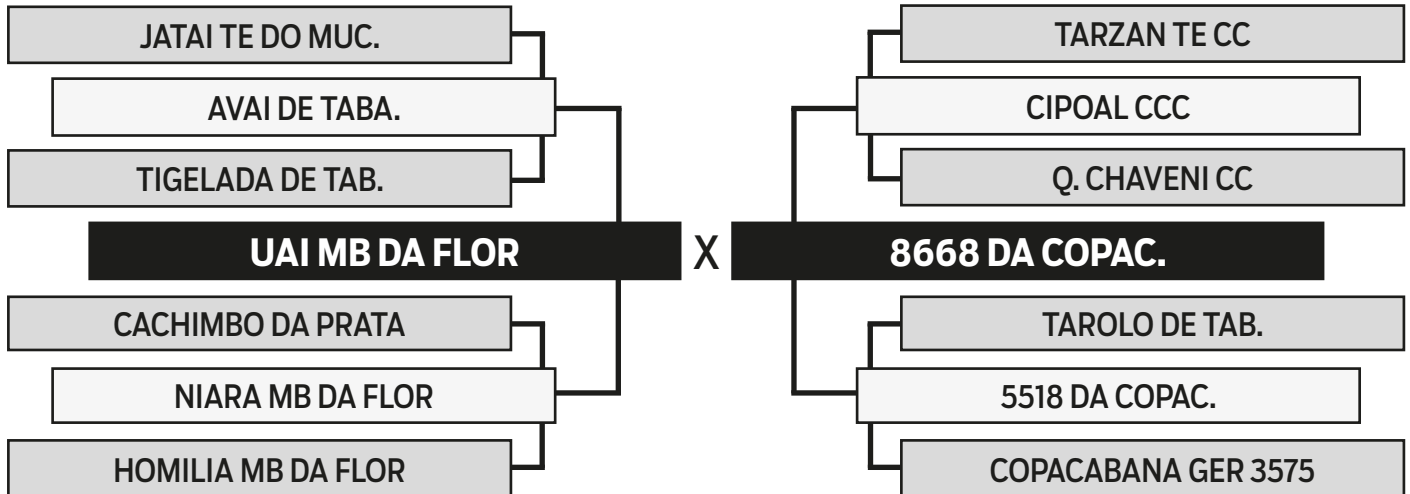

AVALIAÇÃO GENÉTICA - PMGZ



iABCZ: **7.61** - DECA: **2**

	PD-ED	PA-ED	PS-ED	PM-EM	TMD	IPP	STAY	PE-365	AOL	ACAB
DEP	5.77	8.30	10.69	2.19	5.77	9.77	30.56	0.40	1.09	-0.05
DECA	1	1	1	1	1	10	7	1	1	6

PRENHE DO DGANO FIV DA NGT
PREVISÃO DE PARTO ENTRE 04/08/2023 E 13/09/2023



LEILÃO TABAPUÃ COPACABANA

LOTE

105

A171 DA COPAC.

R\$ **450,00**
x 30 parcelas
(2+2+2+2+2+2+18)
Valor por parcela

SEXO: FÊMEA - RAÇA: TABAPUÃ PO - REG: GER A171 - NASC.: 29/09/2020
PESO: 474 KG

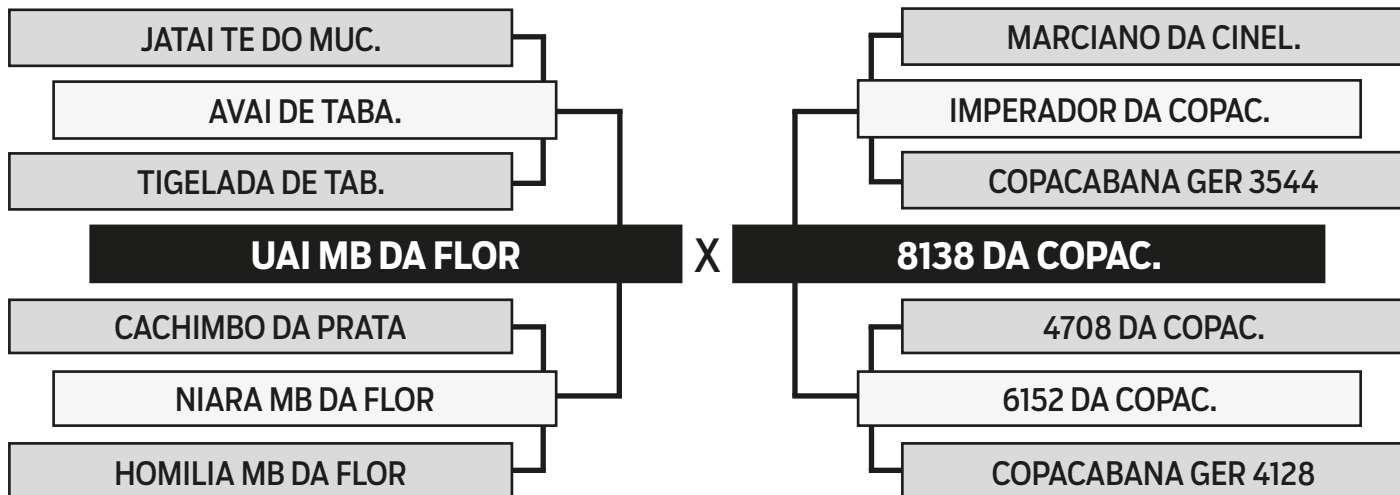

AVALIAÇÃO GENÉTICA - PMGZ



iABCZ: **9.69** - DECA: **2**

	PD-ED	PA-ED	PS-ED	PM-EM	TMD	IPP	STAY	PE-365	AOL	ACAB
DEP	4.55	6.55	9.99	2.48	5.69	5.11	31.77	0.52	1.54	-0.75
DECA	2	1	1	1	1	8	5	1	1	9

PRENHE DO DGANO FIV DA NGT
PREVISÃO DE PARTO ENTRE 04/08/2023 E 13/09/2023



LEILÃO TABAPUÃ COPACABANA

LOTE

106

A174 DA COPAC.

R\$ **450,00**
x 30 parcelas
(2+2+2+2+2+2+18)
Valor por parcela

SEXO: FÊMEA - RAÇA: TABAPUÃ PO - REG: GER A174 - NASC.: 02/10/2020
PESO: 472 KG

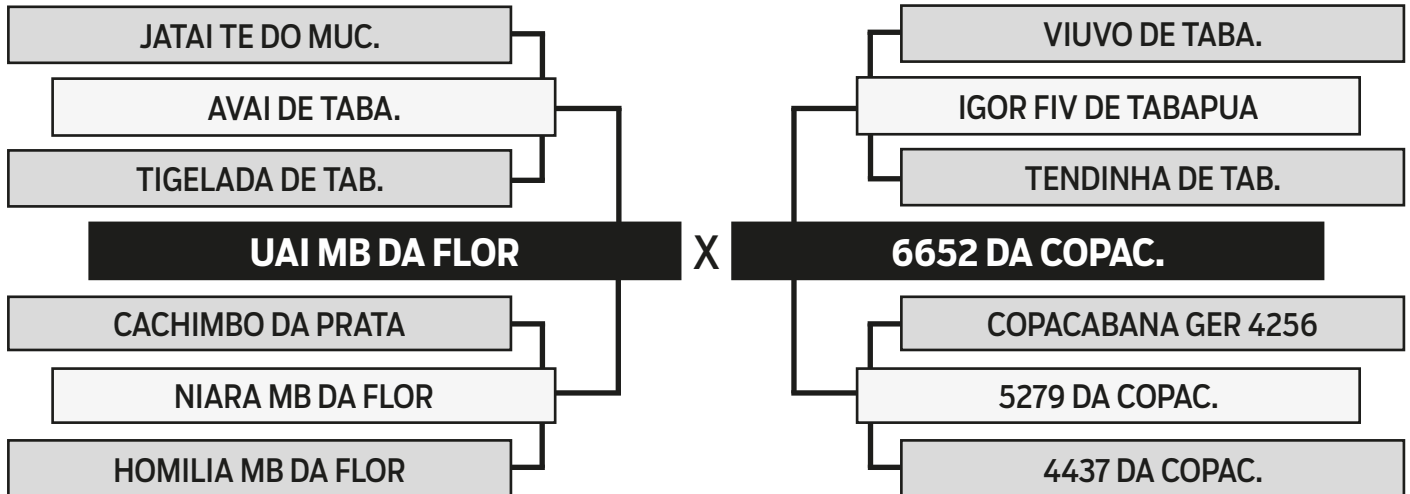

AVALIAÇÃO GENÉTICA - PMGZ



iABCZ: **9.30** - DECA: **2**

	PD-ED	PA-ED	PS-ED	PM-EM	TMD	IPP	STAY	PE-365	AOL	ACAB
DEP	6.65	8.47	10.95	3.59	8.22	1.16	29.29	0.46	1.02	-0.49
DECA	1	1	1	1	1	6	9	1	1	8

PRENHE DO AMULETO DA COPAC.
PREVISÃO DE PARTO ENTRE 22/09/2023 E 01/11/2023



LEILÃO TABAPUÃ COPACABANA

LOTE

107

A186 DA COPAC.

R\$ **400,00**
x 30 parcelas
(2+2+2+2+2+2+18)
Valor por parcela

SEXO: FÊMEA - RAÇA: TABAPUÃ PO - REG: GER A186 - NASC.: 04/10/2020
PESO: 490 KG

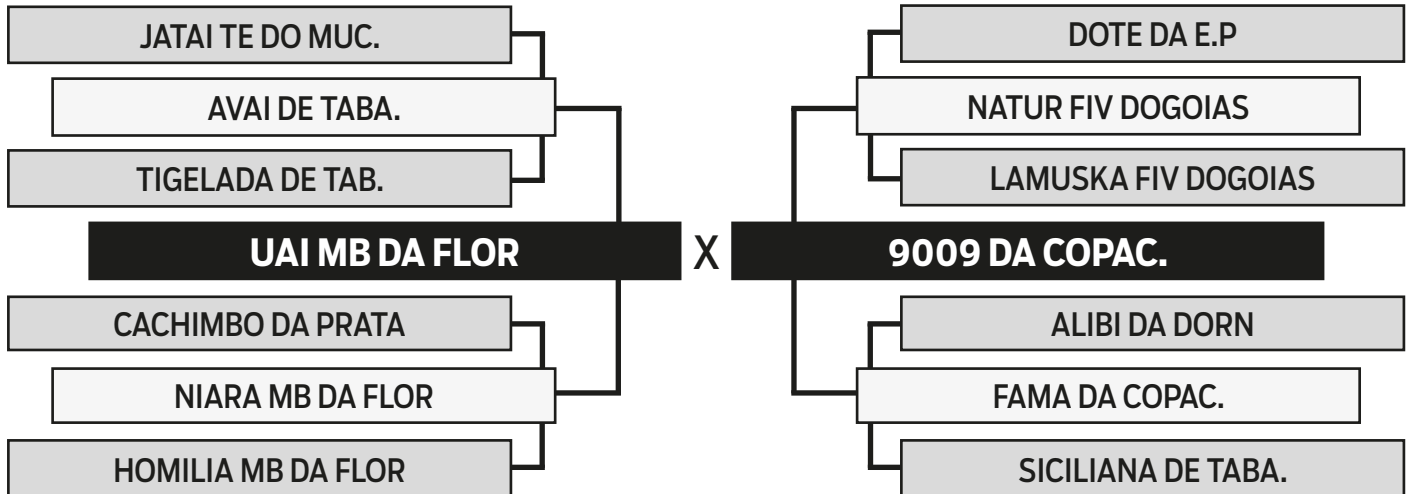

AVALIAÇÃO GENÉTICA - PMGZ



iABCZ: **11.94** - DECA: **1**

	PD-ED	PA-ED	PS-ED	PM-EM	TMD	IPP	STAY	PE-365	AOL	ACAB
DEP	8.48	9.47	12.46	2.39	7.48	0.22	30.38	0.54	1.24	-0.50
DECA	1	1	1	1	1	6	8	1	1	8

PRENHE DO DGANO FIV DA NGT
PREVISÃO DE PARTO ENTRE 04/08/2023 E 13/09/2023



LEILÃO TABAPUÃ COPACABANA

LOTE

108

A202 DA COPAC.

R\$ **400,00**
x 30 parcelas
(2+2+2+2+2+2+18)
Valor por parcela

SEXO: FÊMEA - RAÇA: TABAPUÃ PO - REG: GER A202 - NASC.: 29/10/2020
PESO: 457 KG

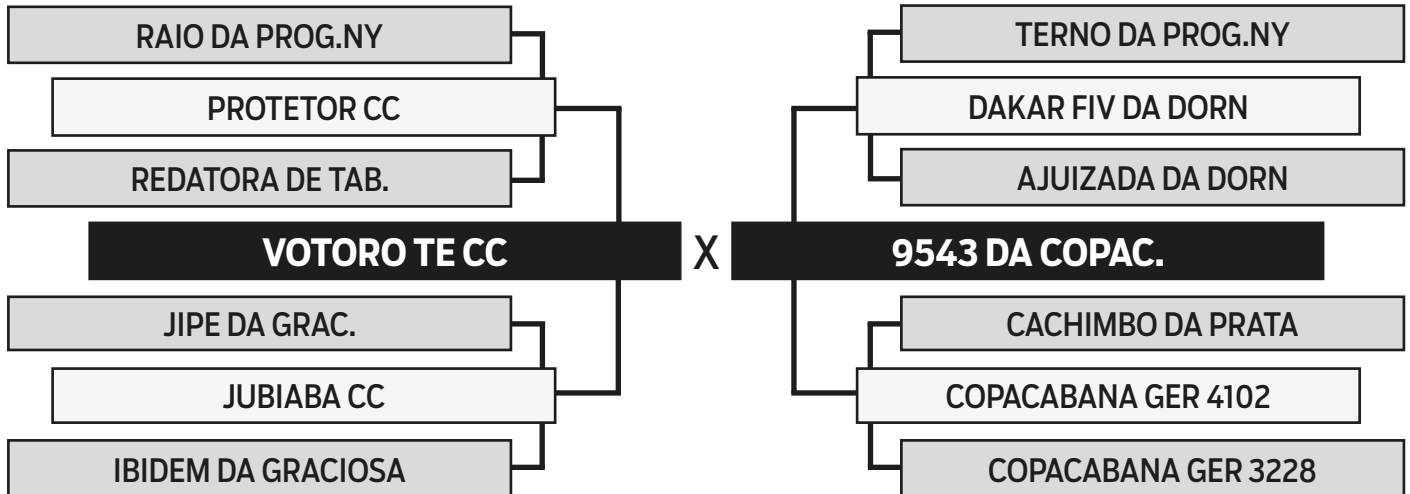

AVALIAÇÃO GENÉTICA - PMGZ



iABCZ: **4.89** - DECA: **4**

	PD-ED	PA-ED	PS-ED	PM-EM	TMD	IPP	STAY	PE-365	AOL	ACAB
DEP	5.14	3.53	5.27	0.22	2.54	-4.70	30.66	0.06	0.04	-0.24
DECA	1	3	3	5	3	3	7	5	6	7

PRENHE DO NITEROI MB DA FLOR
PREVISÃO DE PARTO ENTRE 04/08/2023 E 13/09/2023



LEILÃO TABAPUÃ COPACABANA

LOTE

109

A203 DA COPAC.

R\$ **400,00**
x 30 parcelas
(2+2+2+2+2+2+18)
Valor por parcela

SEXO: FÊMEA - RAÇA: TABAPUÃ PO - REG: GER A203 - NASC.: 29/10/2020
PESO: 405 KG

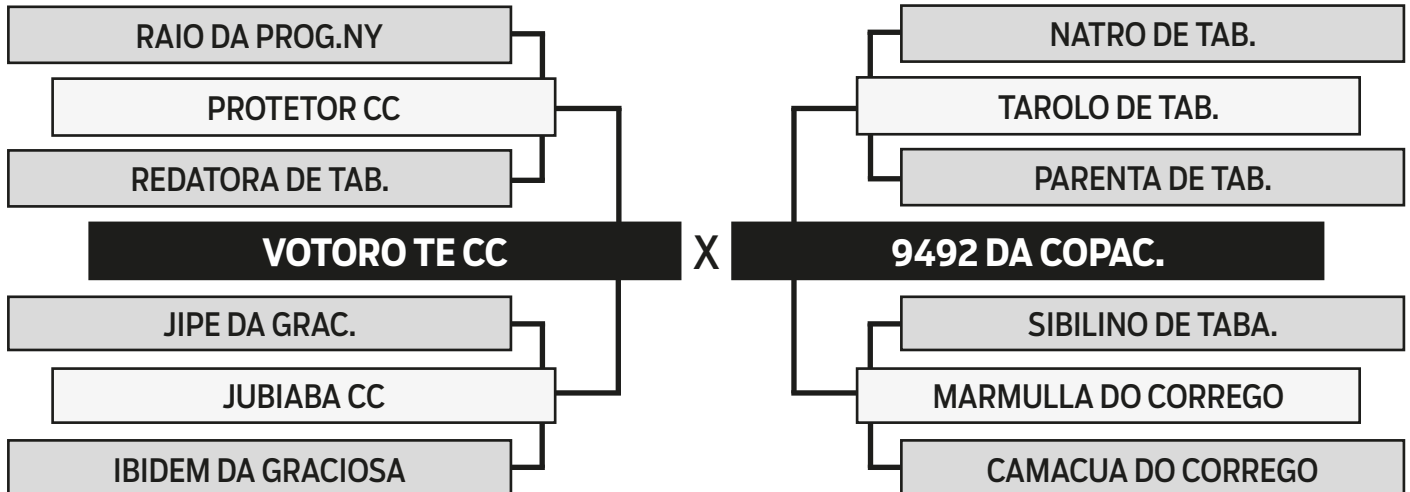

AVALIAÇÃO GENÉTICA - PMGZ



iABCZ: **0.87** - DECA: **6**

	PD-ED	PA-ED	PS-ED	PM-EM	TMD	IPP	STAY	PE-365	AOL	ACAB
DEP	2.28	2.13	3.16	-0.76	-0.10	-2.27	30.49	0.03	0.26	-0.32
DECA	4	5	4	8	7	5	7	5	5	7

PRENHE DO AMULETO DA COPAC.
PREVISÃO DE PARTO ENTRE 22/09/2023 E 01/11/2023



LEILÃO TABAPUÃ COPACABANA

LOTE

110

A211 DA COPAC.

R\$ **350,00**
x 30 parcelas
(2+2+2+2+2+2+18)
Valor por parcela

SEXO: FÊMEA - RAÇA: TABAPUÃ PO - REG: GER A211 - NASC.: 30/10/2020
PESO: 400 KG

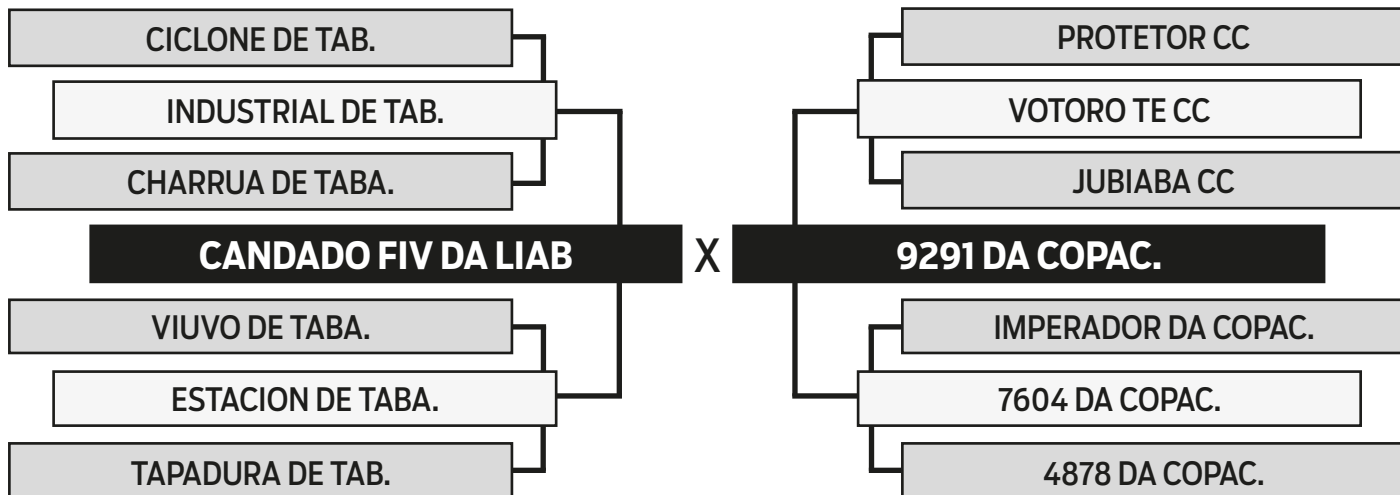

AVALIAÇÃO GENÉTICA - PMGZ



iABCZ: **3.44** - DECA: **4**

	PD-ED	PA-ED	PS-ED	PM-EM	TMD	IPP	STAY	PE-365	AOL	ACAB
DEP	2.04	1.33	2.47	-2.74	-2.28	8.55	34.91	0.02	0.47	-1.62
DECA	4	5	5	10	9	9	1	6	3	10

PRENHE DO AMULETO DA COPAC.
PREVISÃO DE PARTO ENTRE 22/09/2023 E 01/11/2023



LEILÃO TABAPUÃ COPACABANA

R\$ **450,00**
x 30 parcelas
(2+2+2+2+2+2+18)
Valor por parcela

LOTE **111**

A219 DA COPAC.

SEXO: FÊMEA - RAÇA: TABAPUÃ PO - REG: GER A219 - NASC.: 03/11/2020
PESO: 435 KG

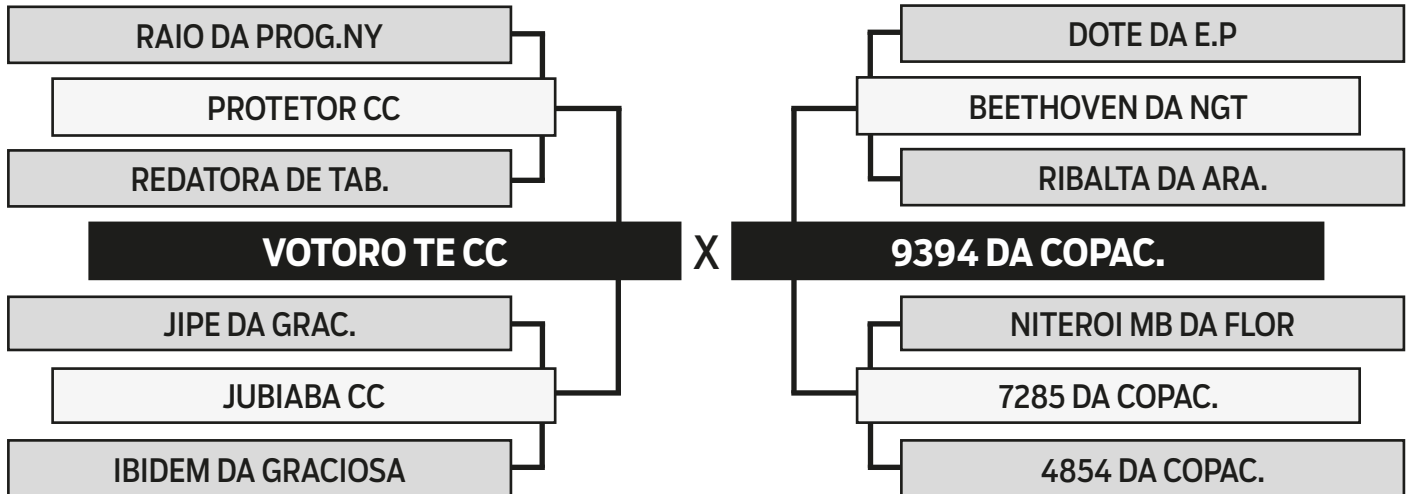

AVALIAÇÃO GENÉTICA - PMGZ



iABCZ: **6.07** - DECA: **3**

	PD-ED	PA-ED	PS-ED	PM-EM	TMD	IPP	STAY	PE-365	AOL	ACAB
DEP	5.31	7.76	8.11	-1.26	0.75	-1.35	31.65	-0.06	0.49	0.06
DECA	1	1	1	9	5	5	5	7	3	5

PRENHE DO AMULETO DA COPAC.
PREVISÃO DE PARTO ENTRE 22/09/2023 E 01/11/2023



LEILÃO TABAPUÃ COPACABANA

LOTE

112

A226 DA COPAC.

R\$ **400,00**
x 30 parcelas
(2+2+2+2+2+2+18)
Valor por parcela

SEXO: FÊMEA - RAÇA: TABAPUÃ PO - REG: GER A226 - NASC.: 03/11/2020
PESO: 370 KG

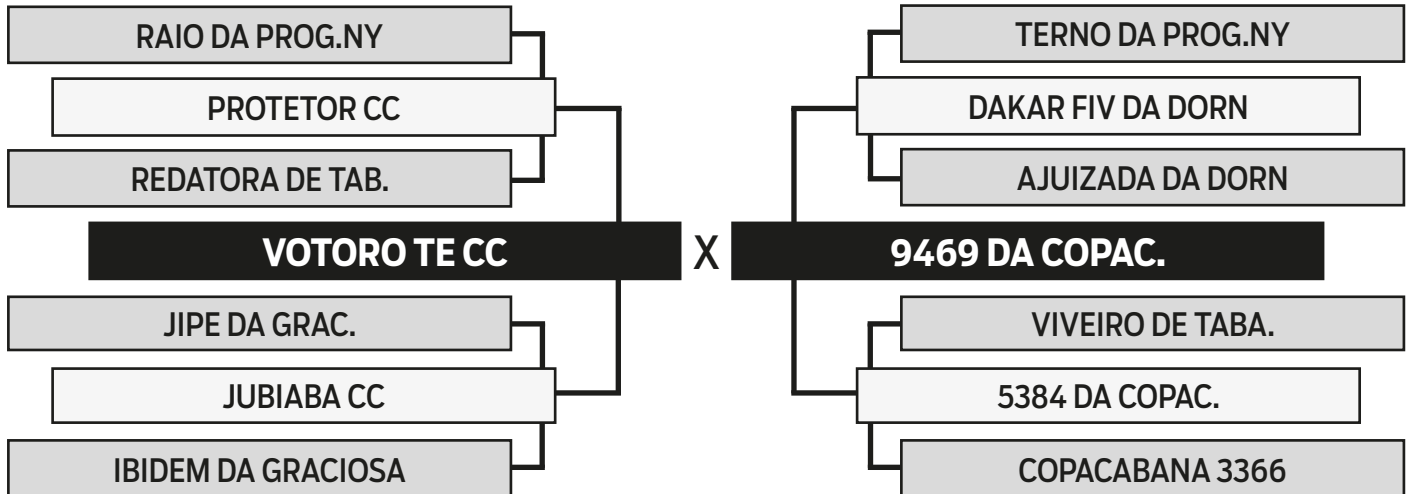

AVALIAÇÃO GENÉTICA - PMGZ



iABCZ: **2.05** - DECA: **5**

	PD-ED	PA-ED	PS-ED	PM-EM	TMD	IPP	STAY	PE-365	AOL	ACAB
DEP	1.07	3.66	3.87	-0.41	-0.14	-3.89	30.93	0.02	0.10	-0.12
DECA	5	3	4	7	7	4	7	6	6	6

PRENHE DO AMULETO DA COPAC.
PREVISÃO DE PARTO ENTRE 17/11/2023 E 27/12/2023



LEILÃO TABAPUÃ COPACABANA

LOTE

113

A234 DA COPAC.

R\$ **400,00**
x 30 parcelas
(2+2+2+2+2+2+18)
Valor por parcela

SEXO: FÊMEA - RAÇA: TABAPUÃ PO - REG: GER A234 - NASC.: 03/11/2020
PESO: 435 KG

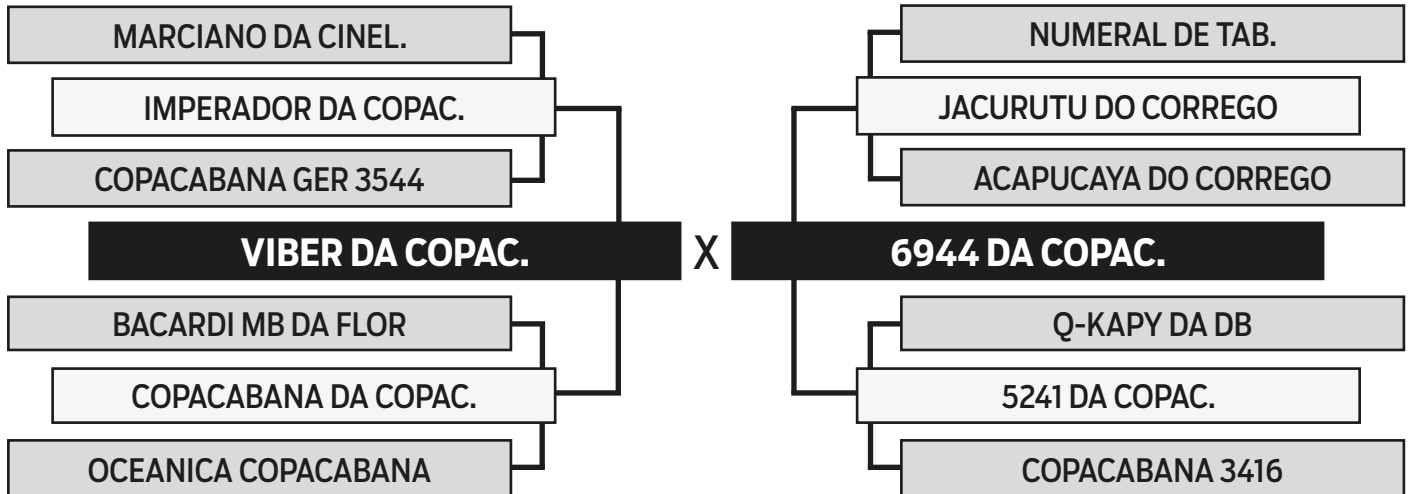

AVALIAÇÃO GENÉTICA - PMGZ



iABCZ: **6.57** - DECA: **3**

	PD-ED	PA-ED	PS-ED	PM-EM	TMD	IPP	STAY	PE-365	AOL	ACAB
DEP	0.97	3.91	6.49	2.51	3.82	-1.34	31.51	0.36	1.22	-0.87
DECA	5	3	2	1	2	5	6	1	1	9

PRENHE DO NITEROI MB DA FLOR
PREVISÃO DE PARTO ENTRE 04/08/2023 E 13/09/2023



LEILÃO TABAPUÃ COPACABANA

LOTE

114

A240 DA COPAC.

R\$ **350,00**
x 30 parcelas
(2+2+2+2+2+2+18)
Valor por parcela

SEXO: FÊMEA - RAÇA: TABAPUÃ PO - REG: GER A240 - NASC.: 06/11/2020
PESO: 385 KG

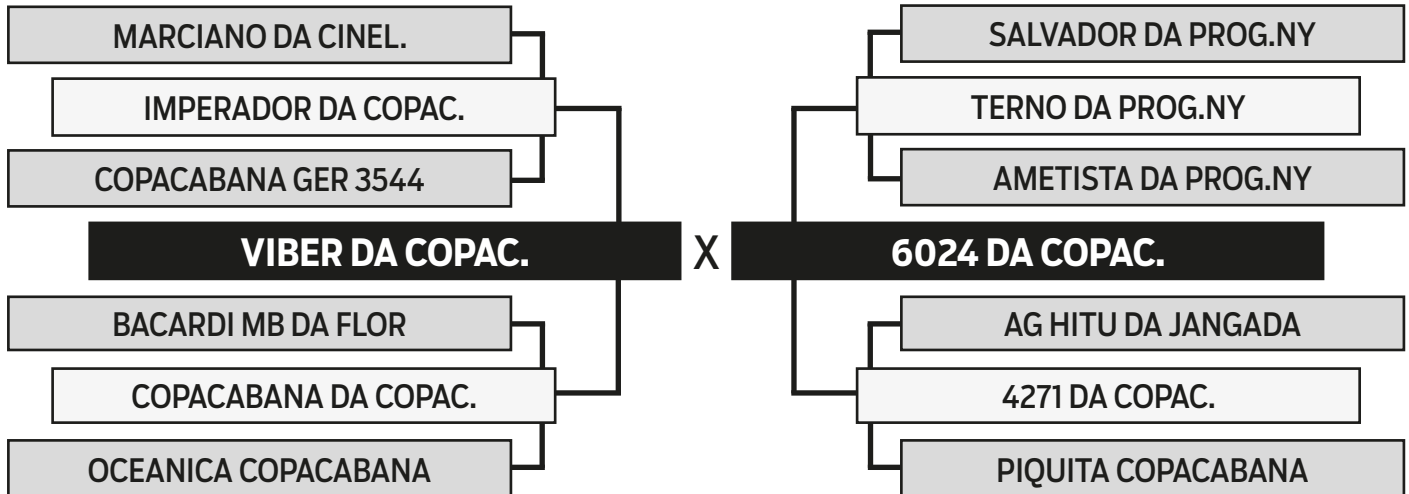

AVALIAÇÃO GENÉTICA - PMGZ



iABCZ: **11.88** - DECA: **1**

	PD-ED	PA-ED	PS-ED	PM-EM	TMD	IPP	STAY	PE-365	AOL	ACAB
DEP	3.15	7.22	11.56	0.67	3.03	-0.07	33.82	0.39	1.47	0.37
DECA	3	1	1	4	2	6	2	1	1	4

PRENHE DO AMULETO DA COPAC.
PREVISÃO DE PARTO ENTRE 22/09/2023 E 01/11/2023



LEILÃO TABAPUÃ COPACABANA

LOTE

115

A243 DA COPAC.

R\$ **350,00**
x 30 parcelas
(2+2+2+2+2+2+18)
Valor por parcela

SEXO: FÊMEA - RAÇA: TABAPUÃ PO - REG: GER A243 - NASC.: 06/11/2020
PESO: 461 KG

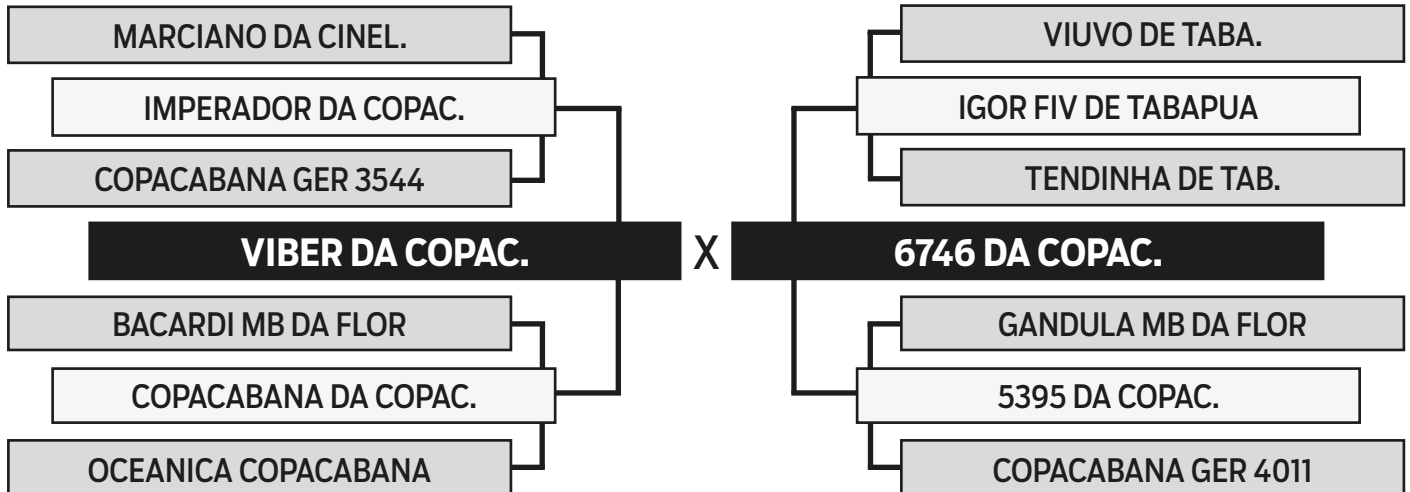

AVALIAÇÃO GENÉTICA - PMGZ



iABCZ: **14.75** - DECA: **1**

	PD-ED	PA-ED	PS-ED	PM-EM	TMD	IPP	STAY	PE-365	AOL	ACAB
DEP	8.51	9.85	14.25	2.86	8.27	-3.83	30.81	0.66	0.72	-0.50
DECA	1	1	1	1	1	4	7	1	2	8

PRENHE DO AMULETO DA COPAC.
PREVISÃO DE PARTO ENTRE 22/09/2023 E 01/11/2023



LEILÃO TABAPUÃ COPACABANA

LOTE

116

A245 DA COPAC.

R\$ **350,00**
x 30 parcelas
(2+2+2+2+2+2+18)
Valor por parcela

SEXO: FÊMEA - RAÇA: TABAPUÃ PO - REG: GER A245 - NASC.: 06/11/2020
PESO: 460 KG

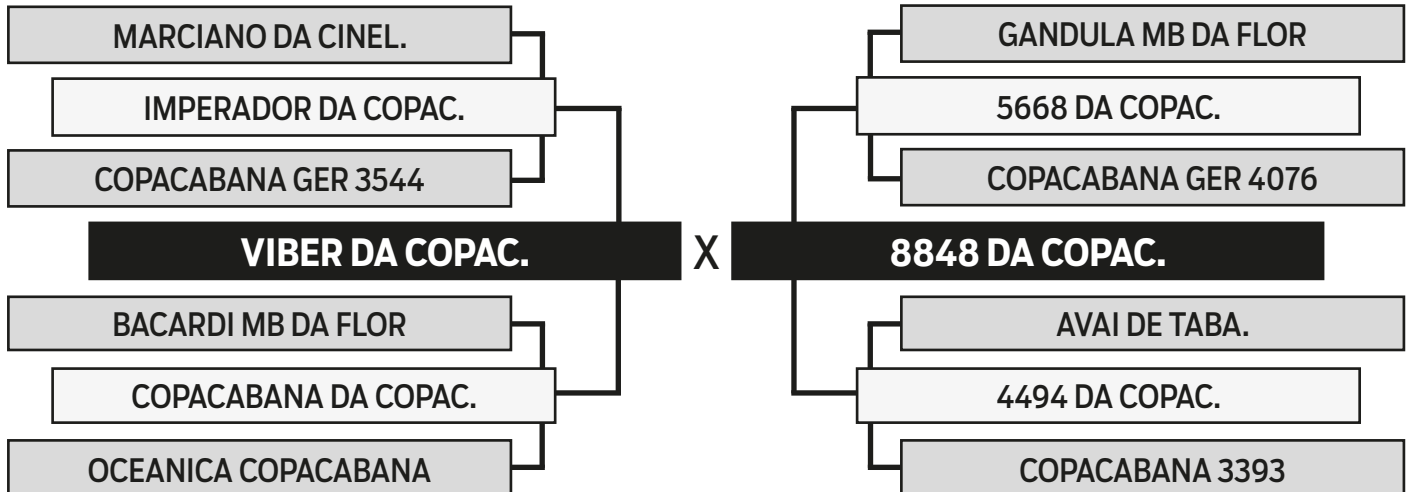

AVALIAÇÃO GENÉTICA - PMGZ



iABCZ: **16.37** - DECA: **1**

	PD-ED	PA-ED	PS-ED	PM-EM	TMD	IPP	STAY	PE-365	AOL	ACAB
DEP	4.29	9.58	13.94	2.08	5.25	0.37	34.65	0.54	1.60	-0.22
DECA	2	1	1	1	1	6	1	1	1	7

PRENHE DO 6827 DA COPAC.
PREVISÃO DE PARTO ENTRE 04/08/2023 E 13/09/2023



LEILÃO TABAPUÃ COPACABANA

LOTE

117

A264 DA COPAC.

R\$ **400,00**
x 30 parcelas
(2+2+2+2+2+2+18)
Valor por parcela

SEXO: FÊMEA - RAÇA: TABAPUÃ PO - REG: GER A264 - NASC.: 10/11/2020
PESO: 414 KG

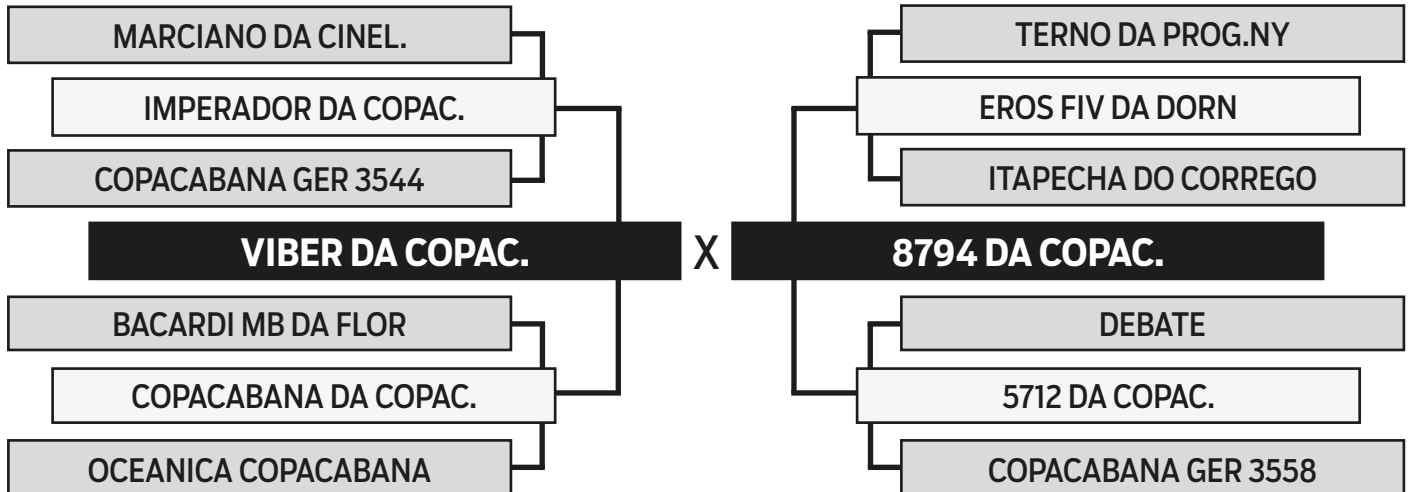

AVALIAÇÃO GENÉTICA - PMGZ



iABCZ: **11.50** - DECA: **1**

	PD-ED	PA-ED	PS-ED	PM-EM	TMD	IPP	STAY	PE-365	AOL	ACAB
DEP	6.42	8.13	9.03	1.39	5.31	-1.72	32.00	0.49	1.57	-0.08
DECA	1	1	1	2	1	5	5	1	1	6

PRENHE DO AMULETO DA COPAC.
PREVISÃO DE PARTO ENTRE 22/09/2023 E 01/11/2023



LEILÃO TABAPUÃ COPACABANA

LOTE

118

A270 DA COPAC.

R\$ **400,00**
x 30 parcelas
(2+2+2+2+2+2+18)
Valor por parcela

SEXO: FÊMEA - RAÇA: TABAPUÃ PO - REG: GER A270 - NASC.: 14/11/2020
PESO: 482 KG

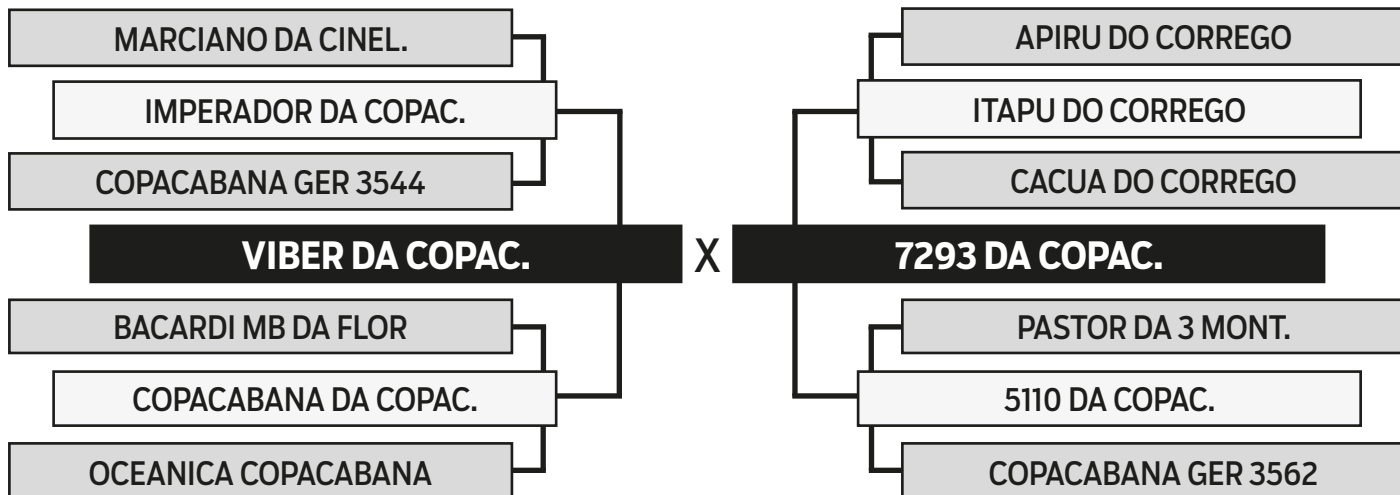

AVALIAÇÃO GENÉTICA - PMGZ



iABCZ: **13.65** - DECA: **1**

	PD-ED	PA-ED	PS-ED	PM-EM	TMD	IPP	STAY	PE-365	AOL	ACAB
DEP	5.59	8.27	12.12	2.13	5.61	0.83	32.99	0.56	1.66	-0.47
DECA	1	1	1	1	1	6	3	1	1	8

PRENHE DO PELOTA UZI
PREVISÃO DE PARTO ENTRE 04/08/2023 E 13/09/2023



LEILÃO TABAPUÃ COPACABANA

LOTE

119

A274 DA COPAC.

R\$ **400,00**
x 30 parcelas
(2+2+2+2+2+2+18)
Valor por parcela

SEXO: FÊMEA - RAÇA: TABAPUÃ PO - REG: GER A274 - NASC.: 14/11/2020
PESO: 444 KG

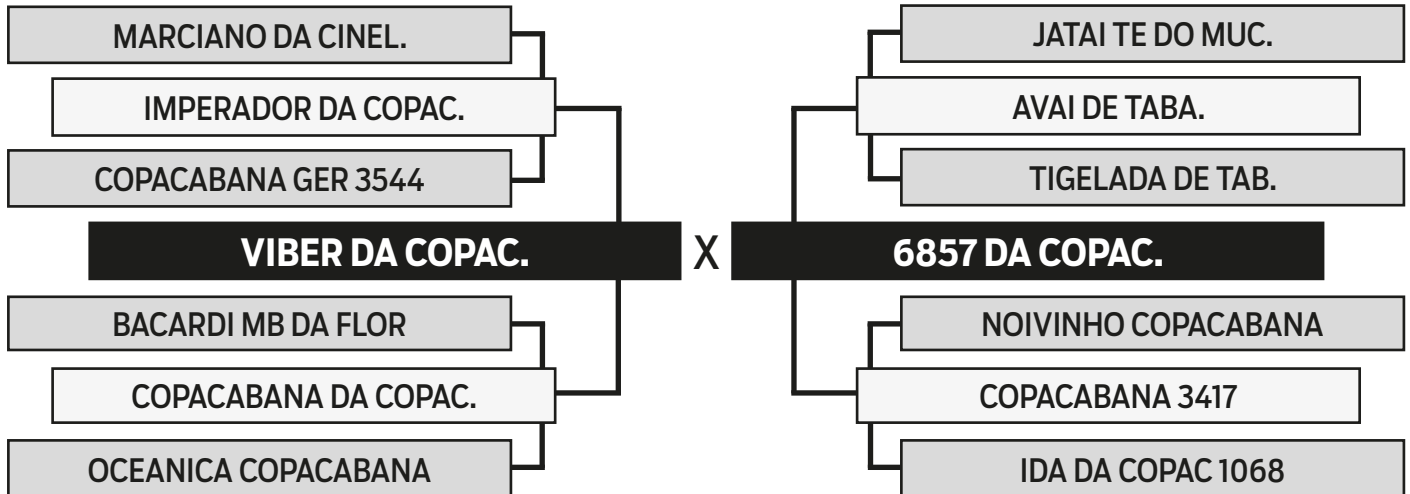

AVALIAÇÃO GENÉTICA - PMGZ



iABCZ: **18.13** - DECA: **1**

	PD-ED	PA-ED	PS-ED	PM-EM	TMD	IPP	STAY	PE-365	AOL	ACAB
DEP	6.23	10.57	13.30	2.59	6.91	-5.22	34.00	0.60	1.70	-0.35
DECA	1	1	1	1	1	3	2	1	1	7

PRENHE DO PELOTA UZI
PREVISÃO DE PARTO ENTRE 04/08/2023 E 13/09/2023



LEILÃO TABAPUÃ COPACABANA

LOTE

120

A278 DA COPAC.

R\$ **400,00**
x 30 parcelas
(2+2+2+2+2+2+18)
Valor por parcela

SEXO: FÊMEA - RAÇA: TABAPUÃ PO - REG: GER A278 - NASC.: 14/11/2020
PESO: 411 KG

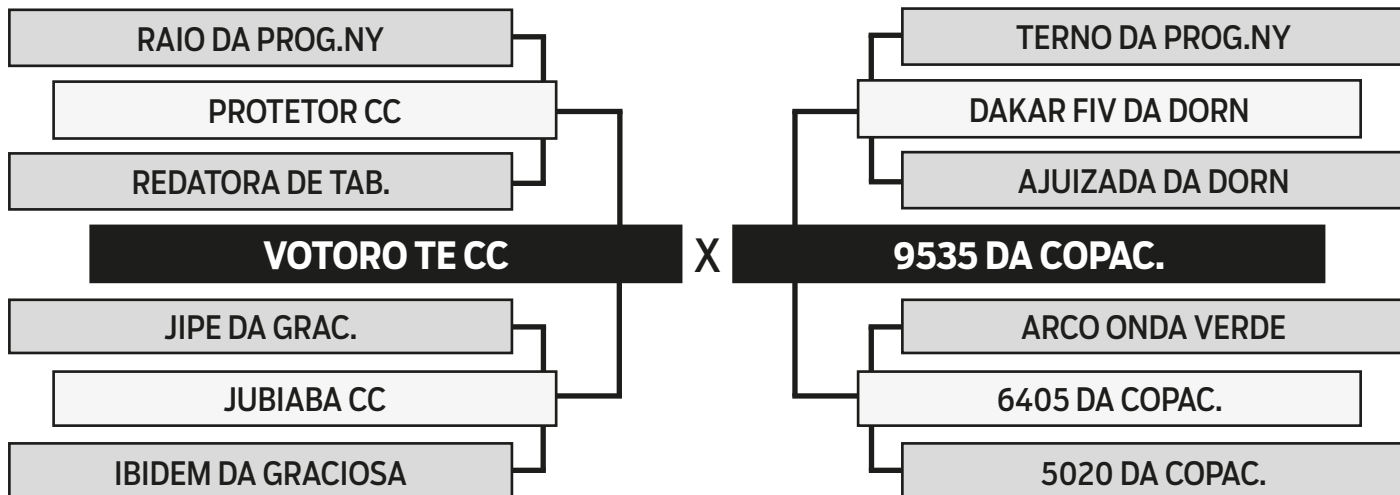

AVALIAÇÃO GENÉTICA - PMGZ



iABCZ: **5.99** - DECA: **3**

	PD-ED	PA-ED	PS-ED	PM-EM	TMD	IPP	STAY	PE-365	AOL	ACAB
DEP	5.26	5.61	6.57	0.10	2.72	-4.44	30.85	0.04	0.41	*
DECA	1	2	2	6	3	4	7	5	4	5

PRENHE DO AMULETO DA COPAC.
PREVISÃO DE PARTO ENTRE 17/11/2023 E 27/12/2023



LEILÃO TABAPUÃ COPACABANA

LOTE

121

A288 DA COPAC.

R\$ **350,00**
x 30 parcelas
(2+2+2+2+2+2+18)
Valor por parcela

SEXO: FÊMEA - RAÇA: TABAPUÃ PO - REG: GER A288 - NASC.: 12/12/2020
PESO: 452 KG

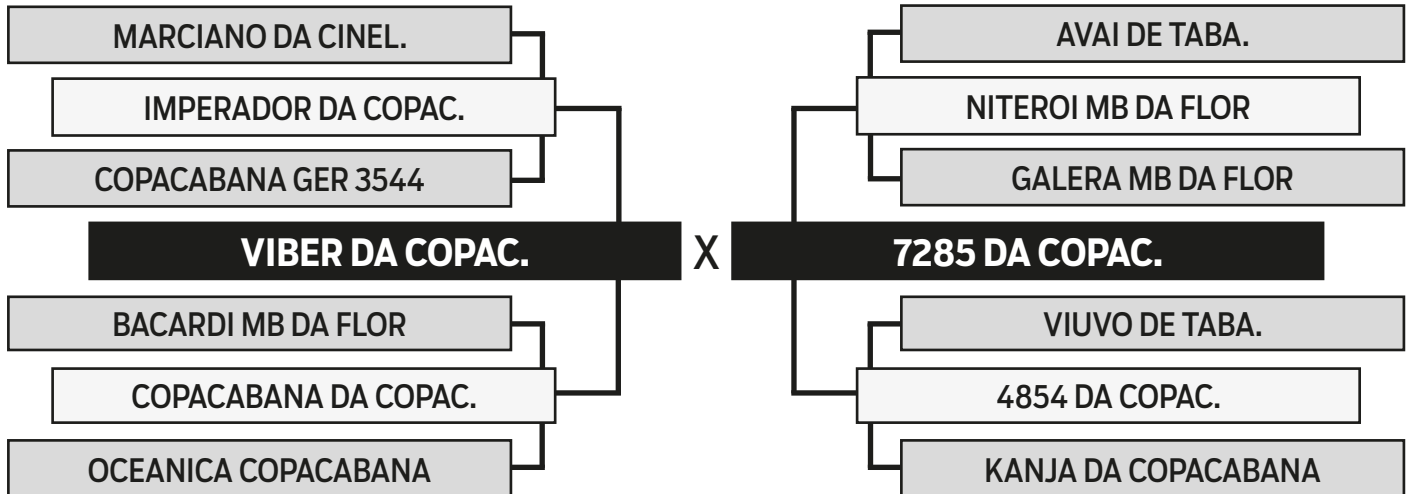

AVALIAÇÃO GENÉTICA - PMGZ



iABCZ: **11.39** - DECA: **1**

	PD-ED	PA-ED	PS-ED	PM-EM	TMD	IPP	STAY	PE-365	AOL	ACAB
DEP	5.43	8.93	12.00	2.16	5.87	4.18	31.98	0.46	0.79	-0.66
DECA	1	1	1	1	1	8	5	1	2	9

PRENHE DO PELOTA UZI
PREVISÃO DE PARTO ENTRE 04/08/2023 E 13/09/2023



LEILÃO TABAPUÃ COPACABANA

LOTE

122

A291 DA COPAC.

R\$ **350,00**
x 30 parcelas
(2+2+2+2+2+2+18)
Valor por parcela

SEXO: FÊMEA - RAÇA: TABAPUÃ PO - REG: GER A291 - NASC.: 15/12/2020
PESO: 414 KG

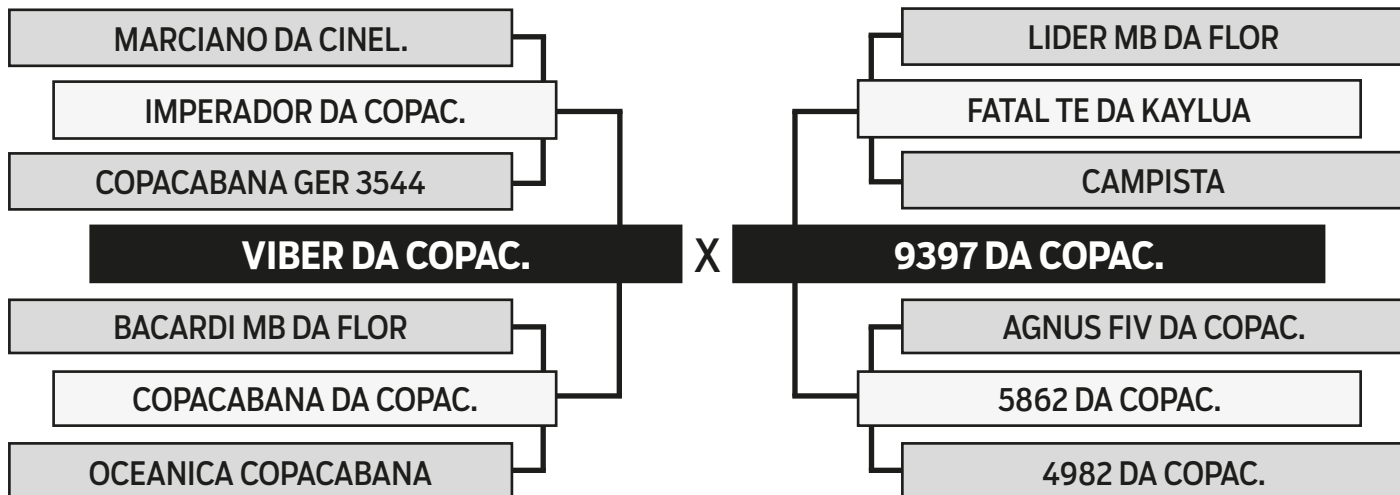

AVALIAÇÃO GENÉTICA - PMGZ



iABCZ: **18.62** - DECA: **1**

	PD-ED	PA-ED	PS-ED	PM-EM	TMD	IPP	STAY	PE-365	AOL	ACAB
DEP	9.94	12.67	16.30	1.88	7.70	-7.93	31.99	0.71	1.60	-0.01
DECA	1	1	1	1	1	2	5	1	1	5

PRENHE DO PELOTA UZI
PREVISÃO DE PARTO ENTRE 04/08/2023 E 13/09/2023



LEILÃO TABAPUÃ COPACABANA

LOTE

123

A293 DA COPAC.

R\$ **450,00**
x 30 parcelas
(2+2+2+2+2+2+18)
Valor por parcela

SEXO: FÊMEA - RAÇA: TABAPUÃ PO - REG: GER A293 - NASC.: 16/12/2020
PESO: 412 KG

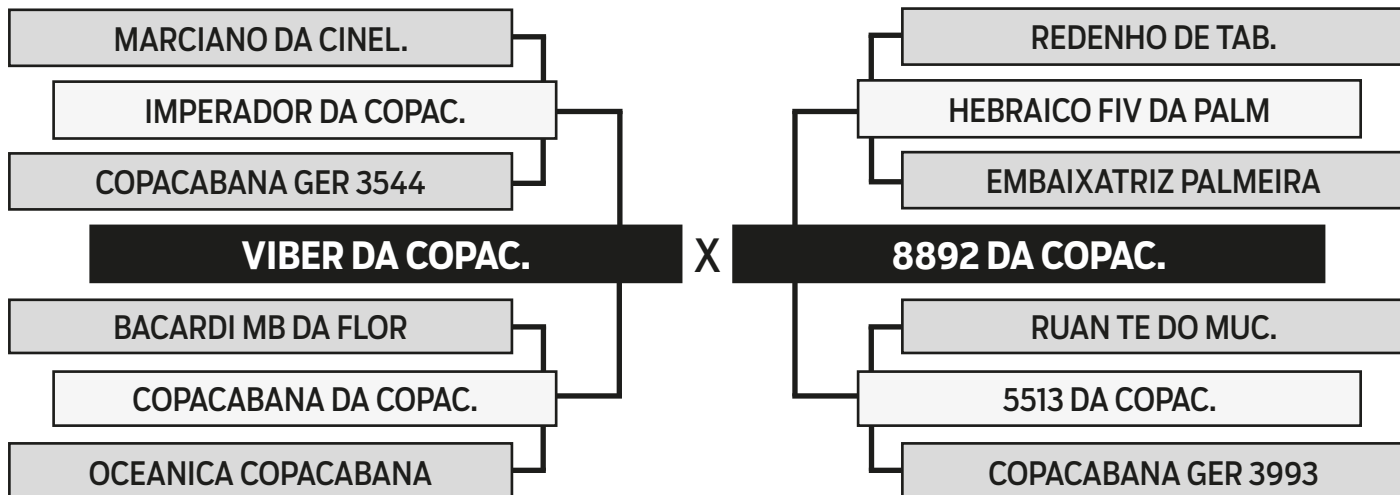

AVALIAÇÃO GENÉTICA - PMGZ



iABCZ: **10.45** - DECA: **1**

	PD-ED	PA-ED	PS-ED	PM-EM	TMD	IPP	STAY	PE-365	AOL	ACAB
DEP	5.31	7.83	9.08	1.36	4.49	-1.28	31.82	0.51	1.20	-0.70
DECA	1	1	1	2	1	5	5	1	1	9

PRENHE DO PELOTA UZI
PREVISÃO DE PARTO ENTRE 04/08/2023 E 13/09/2023



LEILÃO TABAPUÃ COPACABANA

LOTE

124

A294 DA COPAC.

R\$ **350,00**
x 30 parcelas
(2+2+2+2+2+2+18)
Valor por parcela

SEXO: FÊMEA - RAÇA: TABAPUÃ PO - REG: GER A294 - NASC.: 18/12/2020
PESO: 407 KG

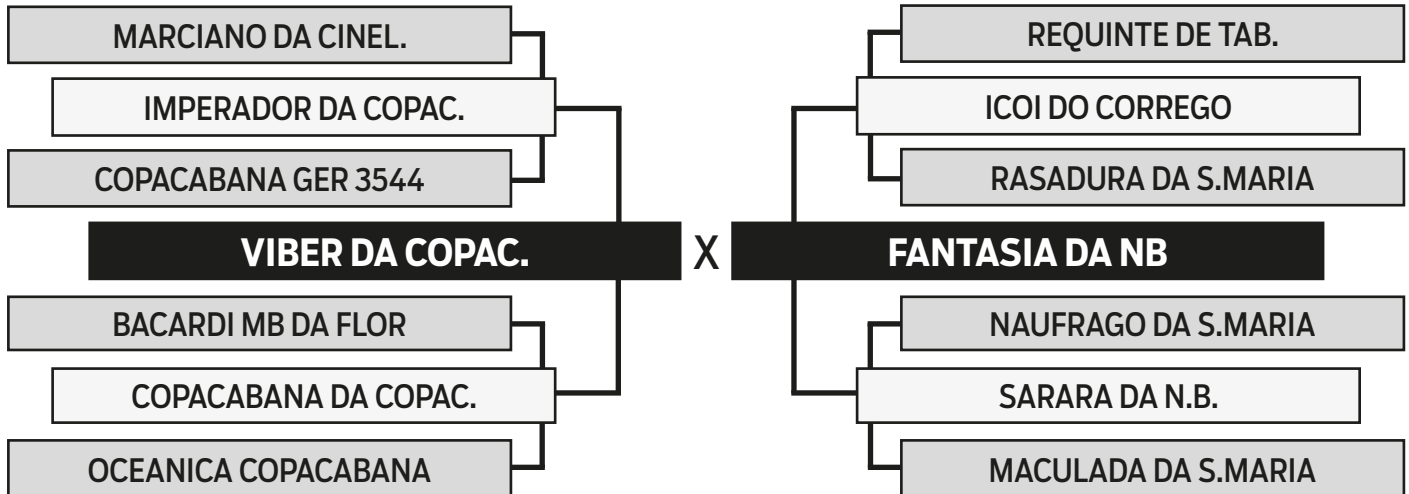

AVALIAÇÃO GENÉTICA - PMGZ



iABCZ: **16.59** - DECA: **1**

	PD-ED	PA-ED	PS-ED	PM-EM	TMD	IPP	STAY	PE-365	AOL	ACAB
DEP	2.31	6.15	9.31	1.09	2.63	-14.70	35.40	0.63	1.57	-0.92
DECA	4	2	1	3	3	1	1	1	1	9

PRENHE DO NITEROI MB DA FLOR
PREVISÃO DE PARTO ENTRE 04/08/2023 E 13/09/2023



LEILÃO TABAPUÃ COPACABANA

LOTE

125

A322 DA COPAC.

R\$ **400,00**
x 30 parcelas
(2+2+2+2+2+2+18)
Valor por parcela

SEXO: FÊMEA - RAÇA: TABAPUÃ PO - REG: GER A322 - NASC.: 29/01/2021
PESO: 430 KG

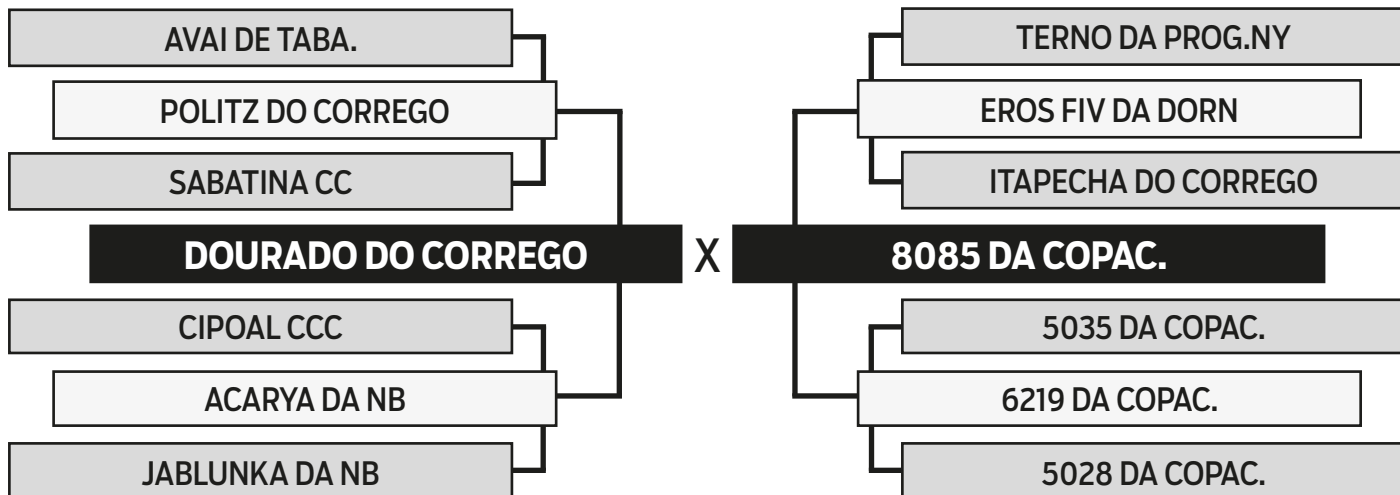

AVALIAÇÃO GENÉTICA - PMGZ



iABCZ: **13.01** - DECA: **1**

	PD-ED	PA-ED	PS-ED	PM-EM	TMD	IPP	STAY	PE-365	AOL	ACAB
DEP	8.27	8.03	9.78	1.07	5.62	2.40	33.66	0.13	0.80	1.55
DECA	1	1	1	3	1	7	2	3	2	1

PRENHE DO AMULETO DA COPAC.
PREVISÃO DE PARTO ENTRE 22/09/2023 E 01/11/2023



LEILÃO TABAPUÃ COPACABANA

LOTE

126

A156 DA COPAC.

R\$ **400,00**
x 30 parcelas
(2+2+2+2+2+2+18)
Valor por parcela

SEXO: FÊMEA - RAÇA: TABAPUÃ PO - REG: GER A156 - NASC.: 25/09/2020
PESO: 420 KG

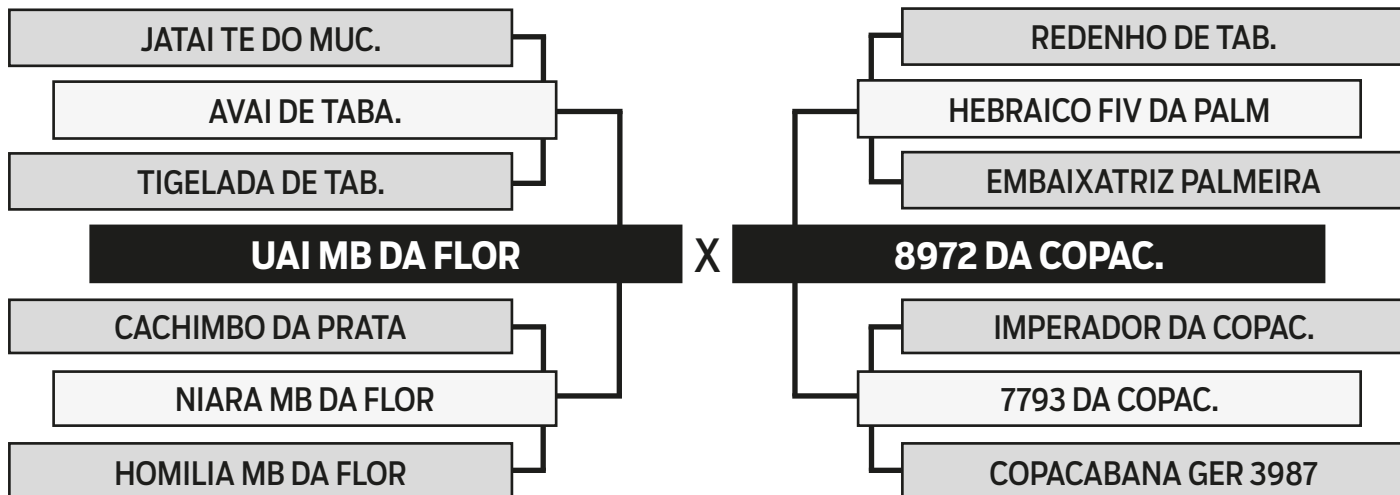

AVALIAÇÃO GENÉTICA - PMGZ



iABCZ: **8.60** - DECA: **2**

	PD-ED	PA-ED	PS-ED	PM-EM	TMD	IPP	STAY	PE-365	AOL	ACAB
DEP	6.01	6.70	8.99	2.51	6.43	3.39	30.55	0.47	1.23	-0.70
DECA	1	1	1	1	1	7	7	1	1	9

PRENHE DO AMULETO DA COPAC.
PREVISÃO DE PARTO ENTRE 22/09/2023 E 01/11/2023



LEILÃO TABAPUÃ COPACABANA

LOTE

127

A172 DA COPAC.

R\$ **400,00**
x 30 parcelas
(2+2+2+2+2+2+18)
Valor por parcela

SEXO: FÊMEA - RAÇA: TABAPUÃ PO - REG: GER A172 - NASC.: 29/09/2020
PESO: 421 KG

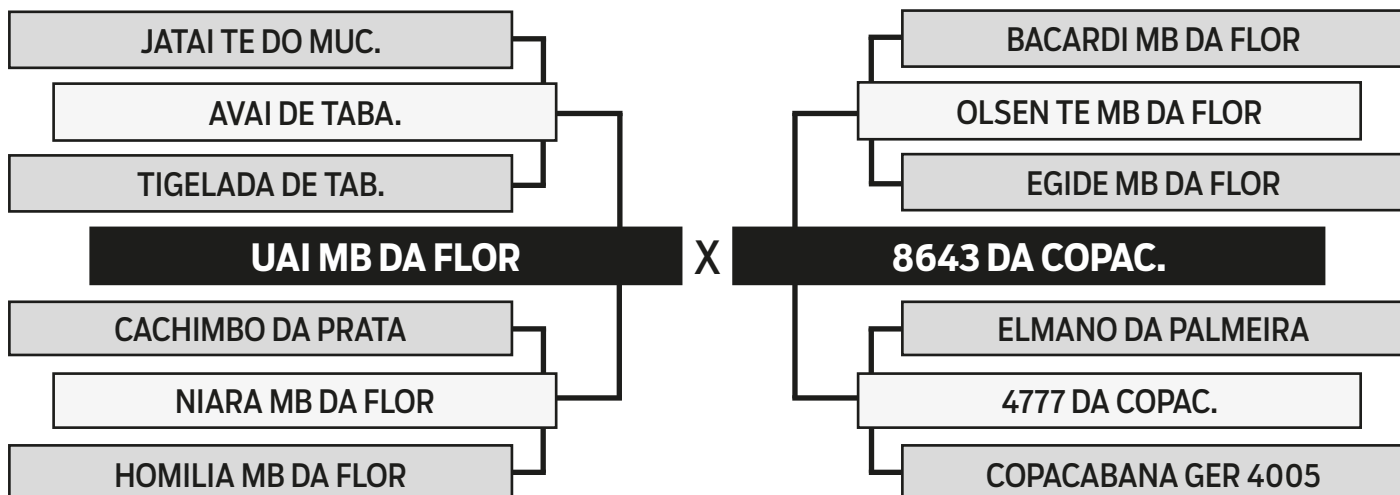

AVALIAÇÃO GENÉTICA - PMGZ



iABCZ: **6.97** - DECA: **3**

	PD-ED	PA-ED	PS-ED	PM-EM	TMD	IPP	STAY	PE-365	AOL	ACAB
DEP	4.70	6.21	8.73	3.41	6.83	9.17	30.43	0.41	1.00	-0.57
DECA	2	1	1	1	1	9	8	1	1	8

PRENHE DO DGANO FIV DA NGT
PREVISÃO DE PARTO ENTRE 04/08/2023 E 13/09/2023



LEILÃO TABAPUÃ COPACABANA

LOTE

128

A197 DA COPAC.

R\$ **350,00**
x 30 parcelas
(2+2+2+2+2+2+18)
Valor por parcela

SEXO: FÊMEA - RAÇA: TABAPUÃ PO - REG: GER A197 - NASC.: 26/10/2020
PESO: 405 KG

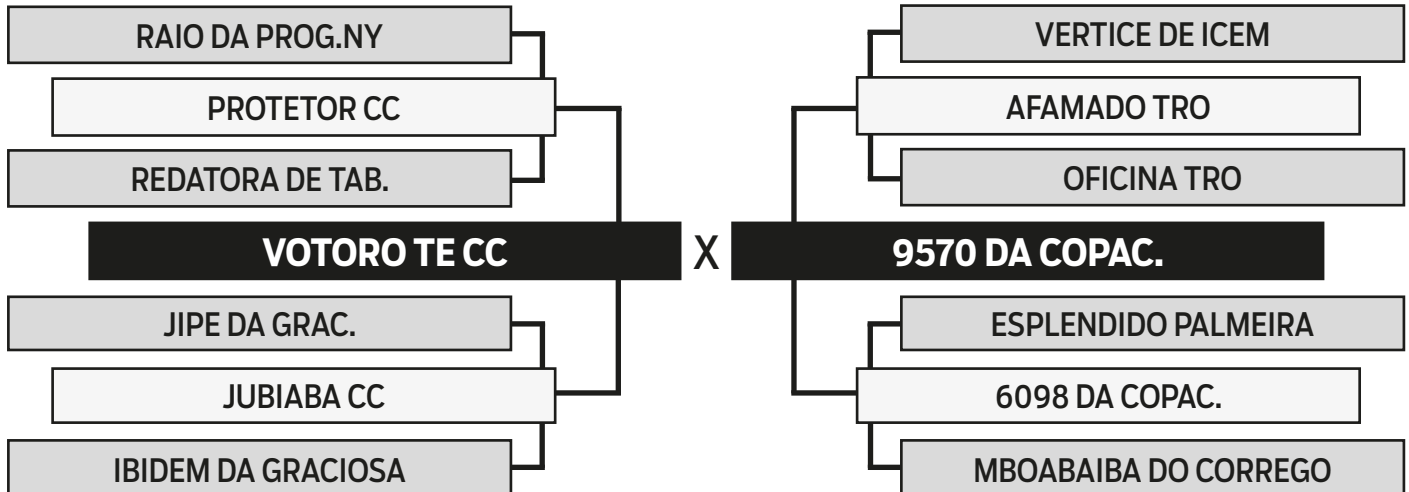

AVALIAÇÃO GENÉTICA - PMGZ



iABCZ: **8.75** - DECA: **2**

	PD-ED	PA-ED	PS-ED	PM-EM	TMD	IPP	STAY	PE-365	AOL	ACAB
DEP	4.53	5.54	6.86	0.75	2.71	-4.65	32.06	0.35	0.15	-0.04
DECA	2	2	2	3	3	3	5	1	5	6

PRENHE DO AMULETO DA COPAC.
PREVISÃO DE PARTO ENTRE 22/09/2023 E 01/11/2023



LEILÃO TABAPUÃ COPACABANA

LOTE

129

A222 DA COPAC.

R\$ **450,00**
x 30 parcelas
(2+2+2+2+2+2+18)
Valor por parcela

SEXO: FÊMEA - RAÇA: TABAPUÃ PO - REG: GER A222 - NASC.: 03/11/2020
PESO: 407 KG

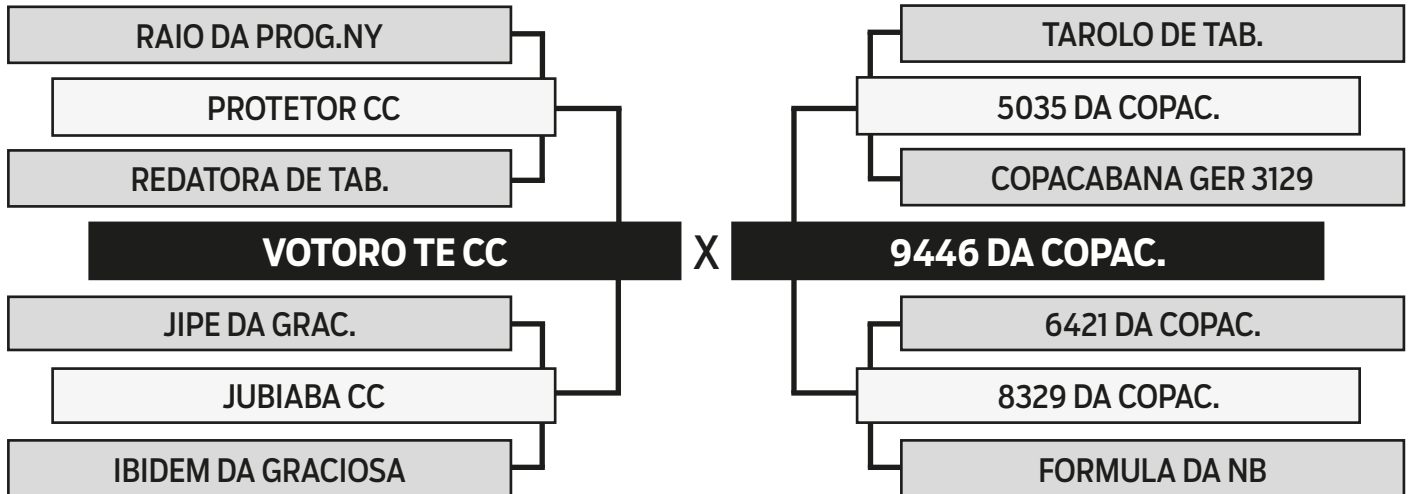

AVALIAÇÃO GENÉTICA - PMGZ



iABCZ: **2.99** - DECA: **5**

	PD-ED	PA-ED	PS-ED	PM-EM	TMD	IPP	STAY	PE-365	AOL	ACAB
DEP	2.60	4.60	4.50	-0.19	0.94	-2.18	30.84	0.02	0.80	-0.08
DECA	3	2	3	7	5	5	7	5	2	6

PRENHE DO NITEROI MB DA FLOR
PREVISÃO DE PARTO ENTRE 04/08/2023 E 13/09/2023



LEILÃO TABAPUÃ COPACABANA

LOTE

130

A236 DA COPAC.

R\$ **400,00**
x 30 parcelas
(2+2+2+2+2+2+18)
Valor por parcela

SEXO: FÊMEA - RAÇA: TABAPUÃ PO - REG: GER A236 - NASC.: 03/11/2020
PESO: 425 KG

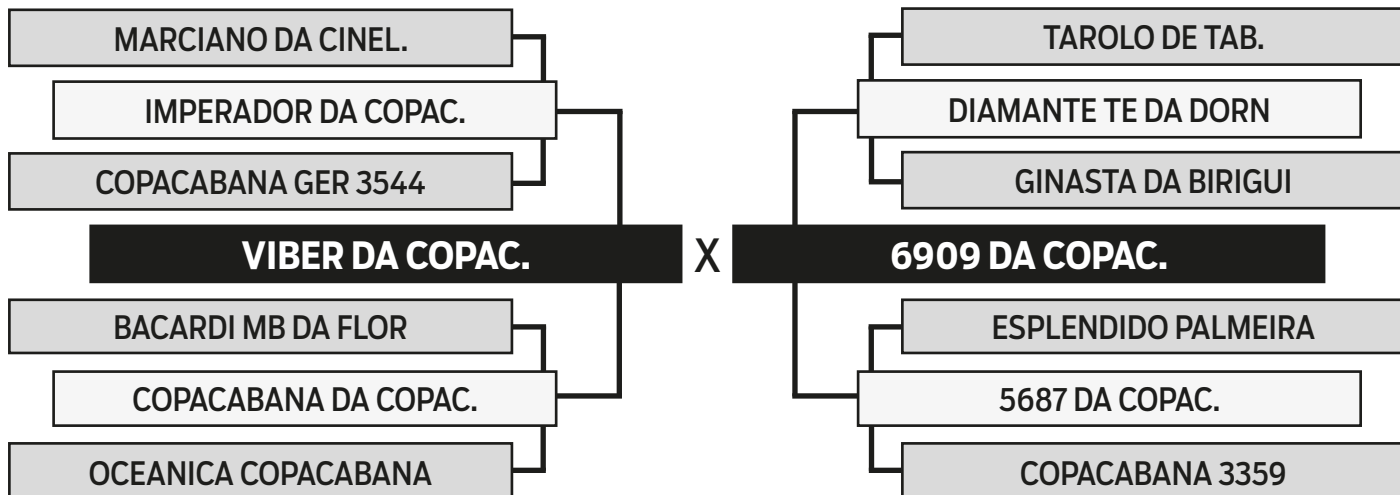

AVALIAÇÃO GENÉTICA - PMGZ



iABCZ: **15.70** - DECA: **1**

	PD-ED	PA-ED	PS-ED	PM-EM	TMD	IPP	STAY	PE-365	AOL	ACAB
DEP	6.43	7.23	11.35	1.87	5.99	-9.38	33.08	0.59	1.09	-0.51
DECA	1	1	1	1	1	2	3	1	1	8

PRENHE DO AMULETO DA COPAC.
PREVISÃO DE PARTO ENTRE 22/09/2023 E 01/11/2023



LEILÃO TABAPUÃ COPACABANA

LOTE

131

A239 DA COPAC.

R\$ **350,00**
x 30 parcelas
(2+2+2+2+2+2+18)
Valor por parcela

SEXO: FÊMEA - RAÇA: TABAPUÃ PO - REG: GER A239 - NASC.: 06/11/2020
PESO: 390 KG

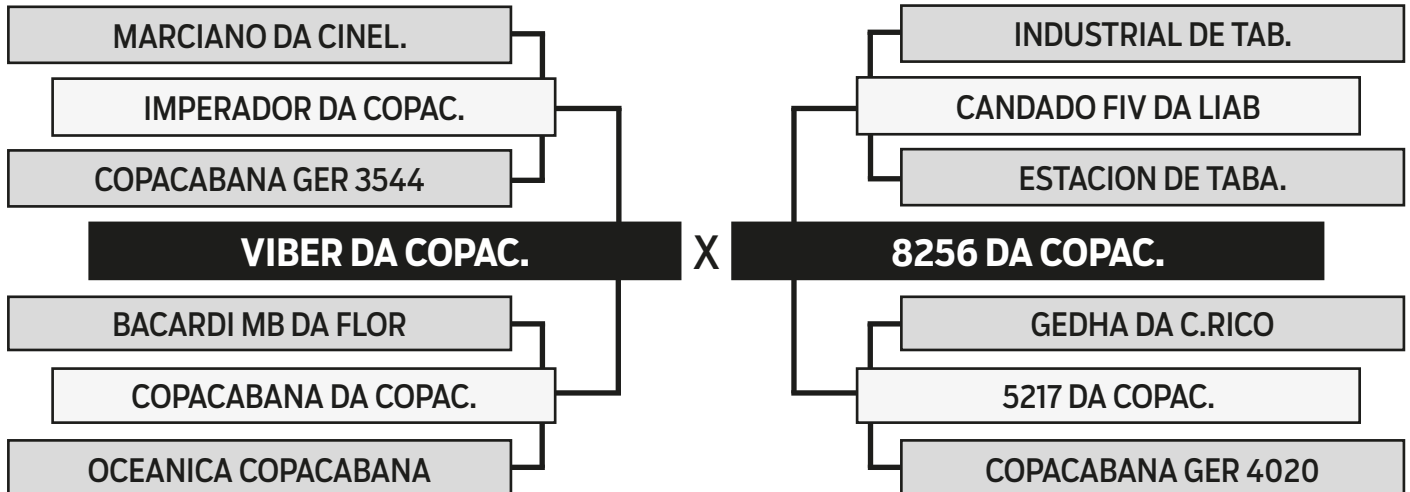

AVALIAÇÃO GENÉTICA - PMGZ



iABCZ: **10.00** - DECA: **2**

	PD-ED	PA-ED	PS-ED	PM-EM	TMD	IPP	STAY	PE-365	AOL	ACAB
DEP	2.95	3.17	6.04	-0.24	1.60	1.42	34.71	0.55	0.98	-1.16
DECA	3	4	2	7	4	6	1	1	1	10

PRENHE DO NITEROI MB DA FLOR
PREVISÃO DE PARTO ENTRE 04/08/2023 E 13/09/2023



LEILÃO TABAPUÃ COPACABANA

LOTE

132

A250 DA COPAC.

R\$ **350,00**
x 30 parcelas
(2+2+2+2+2+2+18)
Valor por parcela

SEXO: FÊMEA - RAÇA: TABAPUÃ PO - REG: GER A250 - NASC.: 06/11/2020
PESO: 410 KG

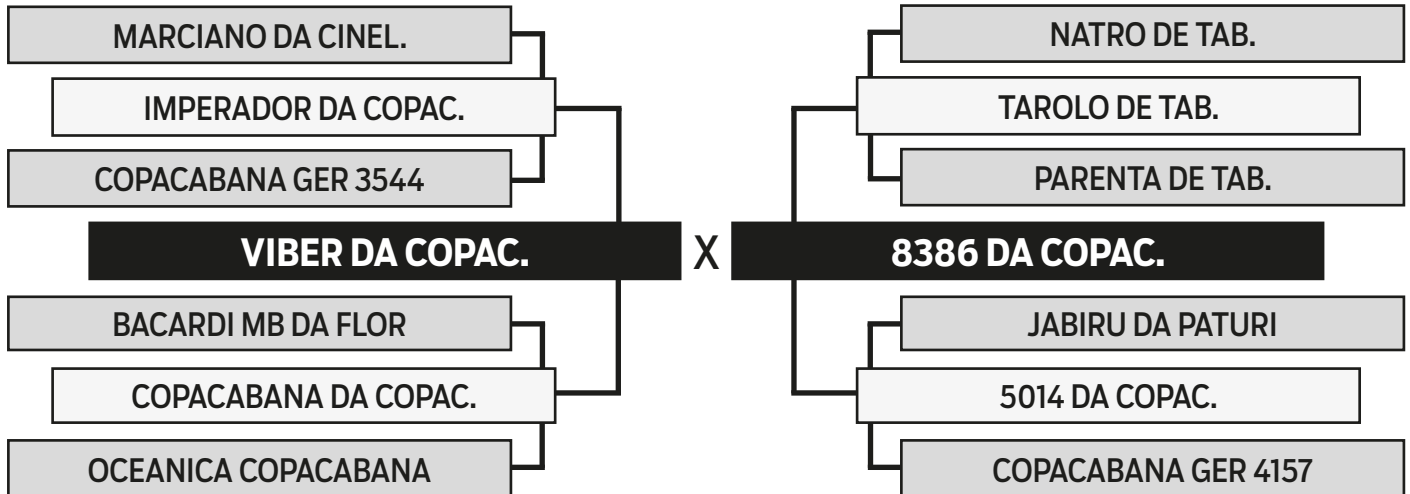

AVALIAÇÃO GENÉTICA - PMGZ



iABCZ: **13.23** - DECA: **1**

	PD-ED	PA-ED	PS-ED	PM-EM	TMD	IPP	STAY	PE-365	AOL	ACAB
DEP	5.79	6.77	10.87	2.09	6.06	-1.65	32.65	0.59	1.46	-0.89
DECA	1	1	1	1	1	5	4	1	1	9

PRENHE DO AMULETO DA COPAC.
PREVISÃO DE PARTO ENTRE 22/09/2023 E 01/11/2023



LEILÃO TABAPUÃ COPACABANA

LOTE

133

A259 DA COPAC.

R\$ **350,00**
x 30 parcelas
(2+2+2+2+2+2+18)
Valor por parcela

SEXO: FÊMEA - RAÇA: TABAPUÃ PO - REG: GER A259 - NASC.: 10/11/2020
PESO: 400 KG

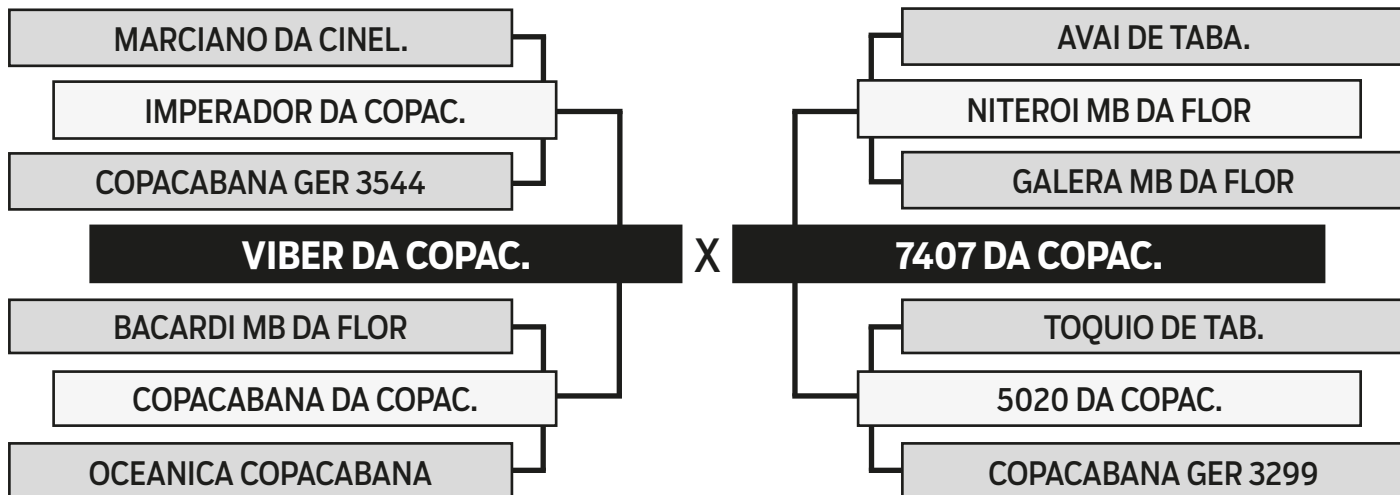

AVALIAÇÃO GENÉTICA - PMGZ



iABCZ: **14.69** - DECA: **1**

	PD-ED	PA-ED	PS-ED	PM-EM	TMD	IPP	STAY	PE-365	AOL	ACAB
DEP	7.20	9.93	13.92	2.57	7.30	-2.05	31.83	0.57	1.19	-0.67
DECA	1	1	1	1	1	5	5	1	1	9

PRENHE DO PELOTA UZI
PREVISÃO DE PARTO ENTRE 04/08/2023 E 13/09/2023



LEILÃO TABAPUÃ COPACABANA

LOTE

134

A289 DA COPAC.

R\$ **350,00**
x 30 parcelas
(2+2+2+2+2+2+18)
Valor por parcela

SEXO: FÊMEA - RAÇA: TABAPUÃ PO - REG: GER A289 - NASC.: 15/12/2020
PESO: 385 KG

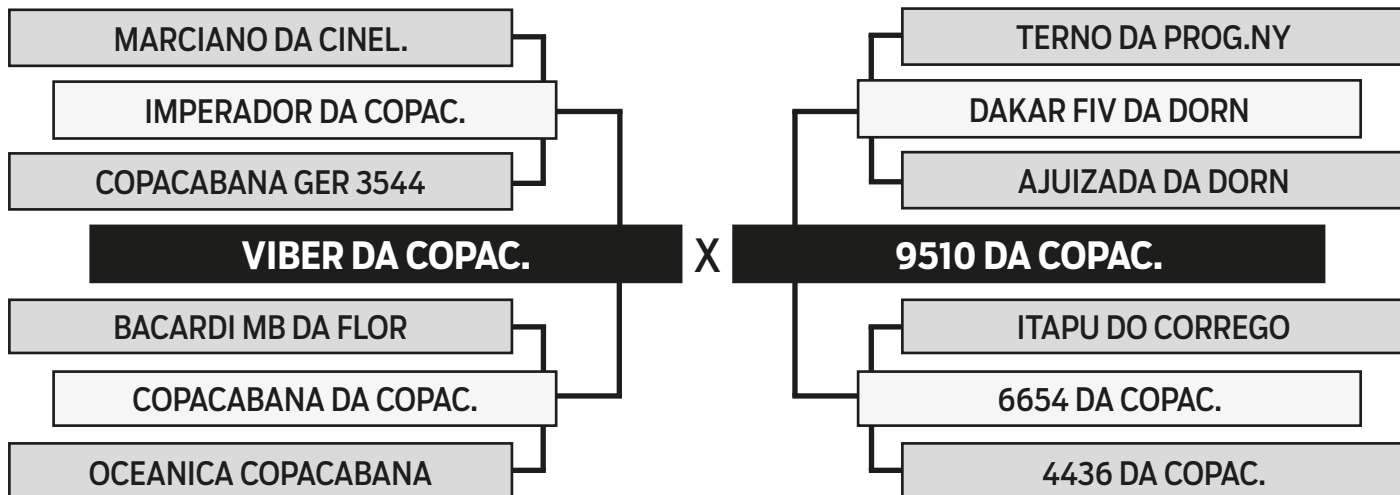

AVALIAÇÃO GENÉTICA - PMGZ



iABCZ: **16.66** - DECA: **1**

	PD-ED	PA-ED	PS-ED	PM-EM	TMD	IPP	STAY	PE-365	AOL	ACAB
DEP	6.35	9.11	12.78	1.87	6.10	-9.61	33.02	0.65	1.44	-0.24
DECA	1	1	1	1	1	2	3	1	1	7

PRENHE DO PELOTA UZI
PREVISÃO DE PARTO ENTRE 04/08/2023 E 13/09/2023



LEILÃO TABAPUÃ COPACABANA

LOTE

135

A301 DA COPAC.

R\$ **350,00**
x 30 parcelas
(2+2+2+2+2+2+18)
Valor por parcela

SEXO: FÊMEA - RAÇA: TABAPUÃ PO - REG: GER A301 - NASC.: 20/12/2020
PESO: 393 KG

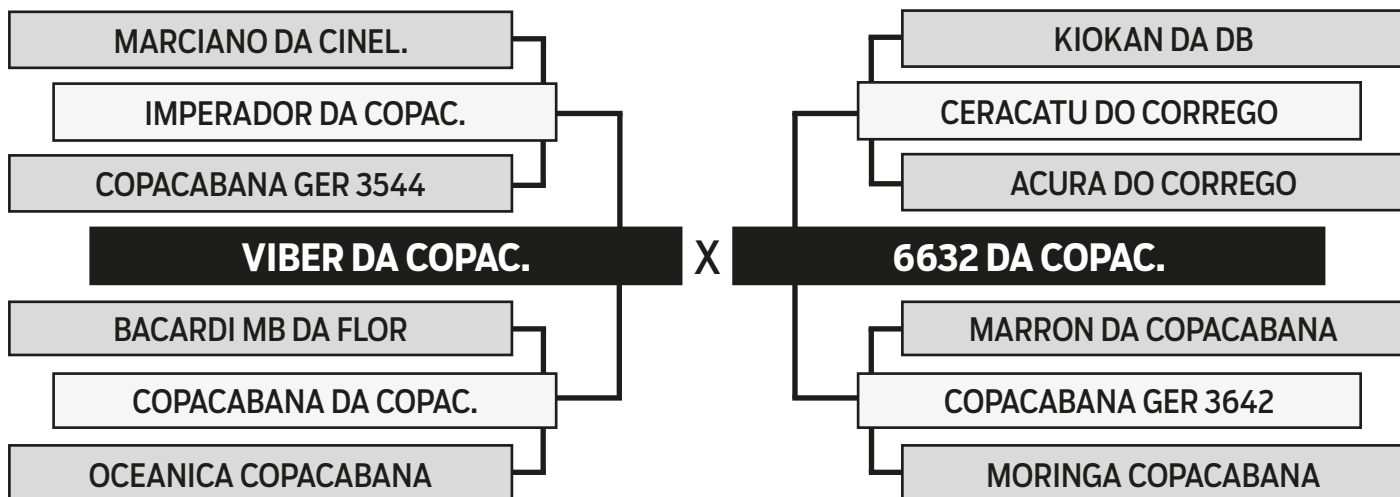

AVALIAÇÃO GENÉTICA - PMGZ



iABCZ: **11.93** - DECA: **1**

	PD-ED	PA-ED	PS-ED	PM-EM	TMD	IPP	STAY	PE-365	AOL	ACAB
DEP	4.55	8.28	9.63	2.38	5.54	-2.34	32.20	0.50	1.60	-0.05
DECA	2	1	1	1	1	5	4	1	1	6

PRENHE DO PELOTA UZI
PREVISÃO DE PARTO ENTRE 04/08/2023 E 13/09/2023



LEILÃO TABAPUÃ COPACABANA

LOTE

136

A313 DA COPAC.

R\$ **400,00**
x 30 parcelas
(2+2+2+2+2+2+18)
Valor por parcela

SEXO: FÊMEA - RAÇA: TABAPUÃ PO - REG: GER A313 - NASC.: 25/12/2020
PESO: 397 KG

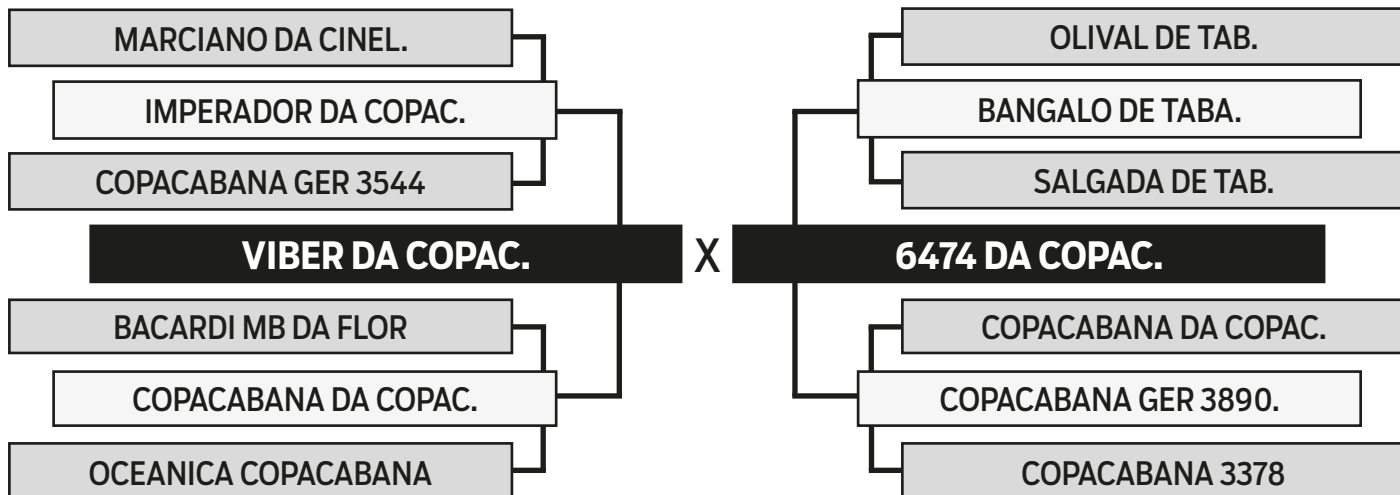

AVALIAÇÃO GENÉTICA - PMGZ



iABCZ: **13.81** - DECA: **1**

	PD-ED	PA-ED	PS-ED	PM-EM	TMD	IPP	STAY	PE-365	AOL	ACAB
DEP	3.52	5.88	11.92	0.62	2.39	0.74	34.99	0.62	1.16	-0.52
DECA	2	2	1	4	3	6	1	1	1	8

PRENHE DO PELOTA UZI
PREVISÃO DE PARTO ENTRE 04/08/2023 E 13/09/2023



LEILÃO TABAPUÃ COPACABANA

LOTE

137

A292 DA COPAC.

R\$ **350,00**
x 30 parcelas
(2+2+2+2+2+2+18)
Valor por parcela

SEXO: FÊMEA - RAÇA: TABAPUÃ PO - REG: GER A292 - NASC.: 16/12/2020
PESO: 406 KG

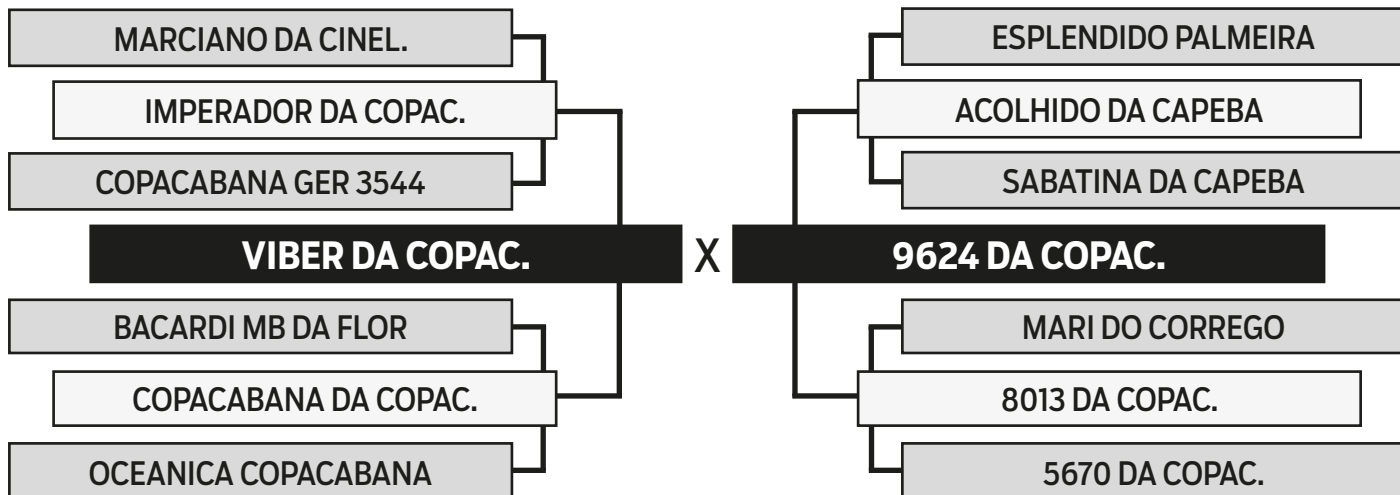

AVALIAÇÃO GENÉTICA - PMGZ



iABCZ: **18.34** - DECA: **1**

	PD-ED	PA-ED	PS-ED	PM-EM	TMD	IPP	STAY	PE-365	AOL	ACAB
DEP	6.14	9.26	13.67	2.34	6.59	-10.57	33.14	0.93	1.95	0.13
DECA	1	1	1	1	1	1	3	1	1	5

PRENHE DO PELOTA UZI
PREVISÃO DE PARTO ENTRE 04/08/2023 E 13/09/2023

