

Leilão Virtual

Moch Brasil



**100 TOUROS
20 NOVILHAS**

NELORE MOCHO

Reprodutores rústicos,
criados a pasto

24 JUNHO

Sábado a partir das 11h

Transmissão:



Leloeira:



(18) 3608-0999

Assessorias:



(16) 3203-8815



(18) 99819-0099

Avaliação:



Apoio:



Uma marca DSM



REGULAMENTO DO LEILÃO

O presente regulamento estabelecerá as normas que serão observadas durante o leilão, sendo que seu cumprimento será obrigatório a todos aqueles que, na condição de convidados, participantes e/ou promotores do evento, quiserem promover a aquisição ou venda de animal(is) ou produto(s) agrobusiness, ou como mero espectador.

1. DEFINIÇÕES

1.1 Considera-se LEILÃO o evento que visa a comercialização de animal(is) e/ou produto(s), pela melhor oferta de valores, efetuada de forma aberta e aceita por um leiloeiro.

1.2 Considera-se EMPRESA LEILOEIRA a empresa responsável pela organização e coordenação do leilão. O presente leilão será coordenado e organizado pela Central Leilões Ltda.

1.3 Considera-se LEILOEIRO a pessoa inscrita no Sindicato Nacional dos Leiloeiros Rurais, detentor de fé-pública, e que será responsável pela recepção das propostas de ofertas aos lotes comercializados, bem como pela batida do martelo e concretização do negócio.

1.4 Considera-se PROMOTOR DO EVENTO a(s) pessoa(s), física(s) ou jurídica(s), que for(em) responsável(is) pela promoção do evento e arrematação do(s) animal(is) ou produto(s) para serem comercializados no leilão.

1.5 Considera-se CONVIDADADO a pessoa, física ou jurídica, que for proprietária de animal(is) ou produto(s) que será(ao) comercializado(s) no leilão. Ao convidado também será permitida a realização de compras no leilão.

1.6 Considera-se PARTICIPANTE todo aquele que comparecer no leilão e que tenha interesse na compra de animal(is) ou produto(s) comercializado(s) no evento, ou como mero espectador.

1.7 Considera-se COMISSÃO DE COMPRA a comissão paga pelo comprador do(s) animal(is) / produto(s) à EMPRESA LEILOEIRA, que será anunciada pelo leiloeiro no início do leilão, cujo percentual incidirá sobre o valor total de cada lote apregoado.

1.8 Considera-se COMISSÃO DE VENDA a comissão paga pelo proprietário do(s) animal(is) / produto(s) ao PROMOTOR DO EVENTO / EMPRESA LEILOEIRA.

1.9 Considera-se PRODUTO tudo que não seja semovente e que possa ser comercializado em leilão, tais como: embrião, sêmen, etc.

1.10 Considera-se LANCE DE DEFESA o lance ofertado pelo próprio proprietário do animal(is) ou produto(s), quando não alcançado o preço esperado por este junto ao leilão. Nesta hipótese, o proprietário será responsável pelo pagamento das comissões de compra e venda acima previstas.

1.11 Considera-se LOTE o grupo de animais ou o animal individualmente e/ou de produtos a serem colocados à venda através de leilão, devidamente identificado no catálogo.

2. CADASTRO:

2.1 Todo aquele que pretenda apresentar lance no leilão deverá estar previamente cadastrado junto à Central Leilões Ltda, podendo encaminhar tal solicitação à empresa leiloeira com antecedência, para fins de análise e aprovação prévia dos cadastros. Nesta hipótese, o pedido de cadastramento importará em autorização automática à empresa leiloeira de consulta de informações do solicitante junto ao SERASA ou outros órgãos de proteção ao crédito.

2.2 A Central Leilões Ltda disponibilizará aos convidados e participantes um escritório no local do evento, podendo o cadastro ser efetuado neste local. Nesta hipótese, toda compra efetuada pelo convidado ou participante ficará condicionada à posterior aprovação do cadastro, bem como aceitação pelo VENDEDOR.

2.3 A presença dos convidados ou participantes no recinto do leilão importará em imediata autorização à Central Leilões Ltda em promover consultas sobre os mesmos junto ao SERASA ou outros órgãos de proteção ao crédito.

2.4 Os empregados da Central Leilões Ltda não estão autorizados a avaliar ou endossar qualquer comprador junto ao leilão.

2.5 A existência de cadastro não dispensará a necessidade de apresentação de avalista, caso seja solicitado pelo VENDEDOR ou pela Central Leilões Ltda.

2.6 Será permitida a compra de animal(is) / produto(s) mediante procuração por Instrumento Público, a qual deverá ser específica para

aquele evento e deverá conter o valor máximo autorizado pelo outorgante e desde que este possua cadastro aprovado junto à Central Leilões Ltda, que permanecerá com referida procuração.

2.7 A Central Leilões Ltda atua como intermediária das transações, sendo responsável pela organização e coordenação do evento, não se responsabilizando pelo inadimplemento do comprador, seja em relação ao valor do(s) produto(s) / animal(is) adquirido(s), seja em relação às comissões de venda. Portanto, cabe ao vendedor manifestar-se sobre o cadastro do comprador antes da assinatura do contrato de compra e venda, bem como exigir a assinatura de avalista antes da formalização deste contrato.

3. DO LEILOEIRO:

3.1 O leilão será realizado por um LEILOEIRO RURAL, devidamente inscrito nos órgãos próprios, sendo que a venda considerará efetuada com a batida do martelo, momento em que as partes, compradores e vendedores, estarão obrigados ao cumprimento do negócio fechado, exceto na hipótese de não aprovação do cadastro do comprador, na forma do item 02 supra.

3.2 Poderá o leiloeiro, durante o leilão, promover as alterações das presentes normas, estabelecer outras regras, alterar as disposições do catálogo, de lotes ou condições de pagamento, instituir preços mínimos, sem direito de reclamação ou indenização por parte dos convidados ou participantes.

4. DISPOSIÇÕES ESPECÍFICAS PARA LEILÃO DE PRENHEZES:

4.1 Salvo estipulação em contrário, nos casos de livre acasalamento ou embrião a ser coletado, a primeira parcela será considerada como sinal de negócio e devidas no ato. As demais parcelas somente poderão ser exigidas do(s) COMPRADOR(es) após o recebimento ou a retirada da(s) prenhez(es) confirmada(s). Caso o VENDEDOR tenha recebido antecipadamente alguma parcela e a prenhez não consiga se realizar o VENDEDOR restituirá ao(s) COMPRADOR(es) o valor recebido.

4.2. PRENHEZES RECEPTORAS:

4.2.1. O VENDEDOR se responsabiliza em apresentar a(s) receptora(s) em perfeitas condições físicas, com boa habilidade materna, a fim de bem criar o embrião.

4.2.2. O COMPRADOR, por sua vez, se compromete a mantê-la(s) sob as mesmas condições de manejo e trato, a fim de não prejudicar o desenvolvimento do embrião adquirido.

4.2.3. O COMPRADOR deverá comunicar imediatamente o VENDEDOR em caso de óbito da receptora e/ou da "cria", bem como de qualquer intercorrência que venha a surgir durante o período gestacional.

4.3. EMBRIÕES A SEREM COLETADOS:

4.3.1. É de responsabilidade de VENDEDOR a coleta e transferência do referido acasalamento, tendo o prazo máximo de 90 dias para a entrega da receptora prenhe, a contar da data da assinatura do presente Contrato, findo o qual poderá o COMPRADOR optar, em comum acordo com o VENDEDOR, escolher outro acasalamento já realizado, de igual importância e valor.

4.4. LIVRES ACASALAMENTOS:

4.4.1. O VENDEDOR oferece a doadora para ser acasalada com o touro da escolha do COMPRADOR, ficando a mesma na propriedade do titular.

4.4.2. O COMPRADOR tem o prazo máximo de 30 dias para enviar o sêmen do reprodutor escolhido, ou autorizar o proprietário da doadora a acasalá-la segundo seu critério.

4.4.3. Todas as despesas provenientes do transporte e aquisição de sêmen que porventura possam ocorrer, serão de inteira responsabilidade do COMPRADOR.

4.4.4. Do acasalamento em questão o COMPRADOR terá direito a apenas uma prenhez proveniente da lavagem, salvo disposição em contrário e acordado entre as partes. Terá também direito a optar se tal prenhez será sexada de macho ou fêmea.

4.4.5. O VENDEDOR garante ao COMPRADOR que a prenhez adquirida venha a nascer com saúde, com garantia de receber RGN (registro geral de nascimento) e RGD (registro geral definitivo).

4.4.6. Caso o produto nascido não preencha os requisitos mencionados no item anterior, deverá o VENDEDOR substituir o produto, caso não possua o mesmo acasalamento, de comum acordo com o COMPRADOR, substituí-lo por outro já nascido de igual categoria e valor.

CONTINUAÇÃO DA PÁGINA ANTERIOR...

4.5 A(s) prenhez(es) será(ão) entregue(s) por malha viária, podendo ainda o COMPRADOR retirá-la da propriedade de origem, sob sua conta e responsabilidade.

5. DISPOSIÇÕES ESPECÍFICAS PARA LEILÃO DE SÊMEN:

5.1. O VENDEDOR responde pela qualidade do sêmen de animal de sua propriedade posto a venda.

6. DISPOSIÇÕES GERAIS PARA TODOS OS LEILÕES:

6.1. O leiloeiro apreçoará, no início de cada lote, o valor do lance que, multiplicado pelo número de parcelas determinadas, formará o preço total de venda e compra do(s) animal(is)/ produto(s). Também será informada a condição de cada venda, data de vencimento das parcelas, condições gerais do(s) produto(s) ou a(s) condição(ões) física(s) do(s) animal(is) referentes a cada lote.

6.2. Os leilões referentes à gado de elite, embrião e sêmen serão realizados com CLÁUSULA DE RESERVA DE DOMÍNIO, que abrangerá inclusive as "crias" advindas destes, conforme disposto no artigo 95 do Código Civil.

6.3. Excetuando o disposto no item 2. deste Regulamento (aprovação de cadastro), as vendas efetuadas durante o leilão são irrevogáveis e irrevogáveis, obrigando comprador e vendedor ao seu cumprimento, por si e por seus herdeiros ou sucessores.

6.4. Ainda que existente índice deflacionário divulgado pelo Governo Federal, os preços estabelecidos no leilão não serão alterados.

6.5. Caberá ao comprador o pagamento do ICMS e ao vendedor o recolhimento do mesmo, referente ao lote adquirido, devendo o segundo informar a Central Leilões Ltda o número de inscrição junto à Receita Estadual.

6.6. A participação no leilão de qualquer pessoa, seja comprador ou vendedor, implicará na presunção de aceitação de todas as normas previstas neste Regulamento, e, face disponibilização deste Regulamento a todos que se encontram presentes no recinto do leilão através do catálogo, não poderá alegar desconhecimento para eximir de seu cumprimento.

6.7. Compradores domiciliados fora do país deverão informar-se no escritório sobre as condições que regem a compra e venda, que no caso presente somente se operará com o pagamento à vista, em moeda corrente do país, no ato do negócio.

6.8. Salvo estabelecido de forma diversa, por escrito, antes do leilão, o comprador será responsável pelo pagamento da comissão de compra, a qual recai sobre o valor do lote no momento da batida do martelo, em favor da EMPRESA LEILOEIRA, cujo percentual será divulgado pelo leiloeiro no início do evento.

6.9. Salvo estabelecido de forma diversa, por escrito, antes do leilão, o vendedor será responsável pelo pagamento da comissão de venda, a qual recai sobre o valor do lote no momento da batida do martelo, em favor do PROMOTOR DO EVENTO / EMPRESA LEILOEIRA, cujo percentual foi acordado anteriormente entre as partes.

6.10. As taxas do leilão, assim como as comissões, para comprador e vendedor, são irrevogáveis e irrevogáveis. No caso da não concretização do negócio após o remate, a parte responsável pelo cancelamento do negócio arcará com as mesmas em sua totalidade.

6.11. EM caso de pagamento à vista das parcelas de compra, o desconto poderá ser concedido pelo vendedor, mas tal desconto não recairá sobre as comissões em favor da Leiloeira.

6.12. No lance de defesa, conforme definição do item 1.10 deste regulamento, o proprietário do animal será responsável pelo pagamento da comissão de compra e venda em favor do PROMOTOR DO EVENTO / EMPRESA LEILOEIRA, sobre o valor do lote no momento da batida do martelo.

6.13. Não serão aceitos pagamentos das parcelas vencíveis no ato da compra com cheques de terceiros.

6.14. Todos os pagamentos efetuados em cheque somente serão considerados quitados com a respectiva compensação.

6.15. As GTAS (Guias de Trânsito dos Animais) serão emitidas exclusivamente em nome do comprador e não poderão ser transferidas a terceiros.

6.16. Os catálogos do leilão são de responsabilidade dos vendedores, não sendo a Central Leilões Ltda responsável por eventuais erros constantes nestes, os quais inclusive poderão ser retificados pelo leiloeiro.

6.17. Quando da batida do martelo os lances forem simultâneos entre dois compradores, o leiloeiro pedirá o retorno do animal à pista e reiniciará a venda dos mesmos, a partir do lance em questão, para o desempate.

6.18. Serão de exclusiva responsabilidade do VENDEDOR o(s) animal(is) colocado(s) a leilão estar(em) saudável(eis), com toda a documentação sanitária atualizada, bem como sua guarda, manutenção e segurança, durante o tempo em que se mantiver(em) no local do leilão, seja no estábulo, em sua propriedade, para os casos de Leilão Virtual, em trânsito ou enquanto estiverem sendo exibidos na pista, até o momento da batida do martelo, passando então, tais responsabilidades a serem exclusivas do COMPRADOR, não restando à Central Leilões Ltda. nenhum ônus sobre o itens mencionados, bem como, em caso de acidente e danos que, eventualmente, venha(m) a ocorrer com o(s) animal(is).

6.18.1. É de responsabilidade do VENDEDOR a veracidade de todas as informações fornecidas à leiloeira referente ao(s) animal(is) e/ou produto(s) colocado(s) a leilão. Bem como, fica o VENDEDOR responsável, cível e criminalmente pela omissão de informar a empresa Leiloeira sobre qualquer intercorrência relacionadas ao(s) animal(is) e/ou produto(s) até o momento do leilão.

6.18.2. Após a batida do martelo, a venda será considerada irrevogável e irrevogável, correndo a partir de então, por conta e risco do COMPRADOR, a vida e integridade física do(s) animal(is), razão pela qual, é facultado a este COMPRADOR, caso opte e se responsabilize pelas despesas, contratar cobertura securitária ao(s) animal(is) arrematados.

6.18.3. A morte do(s) animal(is), com seguro ou não, anomalias físicas encontradas no animal(is) por exames radiológicos ou outros, perda de prenhes, estado do(s) animal(is) no ato da entrega pelo VENDEDOR e outros motivos não inerentes ao momento da venda) a leiloeira não se obriga nos termos deste regulamento.

6.18.4. Tanto para os leilões presenciais, bem como para os leilões virtuais, após a batida do martelo, fica facultado entre VENDEDOR e COMPRADOR decidirem o momento mais apropriado para o transporte do(s) animal(is). Porém, os riscos inerentes ao(s) animal(is) arrematados até o momento do seu transporte, correrá por conta exclusiva do COMPRADOR, não podendo o VENDEDOR ficar responsável pela vida e integridade física do(s) animal(is) até seu efetivo embarque para transporte, salvo comprovada sua exclusiva culpa.

6.19. No caso de comercialização efetuada através de canal fechado de televisão (Leilões Virtuais), o vendedor compromete-se a entregar o(s) animal(is) (independente do local de entrega), somente quando tiver em sua posse a respectiva documentação de venda, devidamente assinada pelo comprador, eximindo a Central Leilões Ltda de qualquer responsabilidade se a presente cláusula não for cumprida.

7. DA AUTORIZAÇÃO DE USO DO NOME, IMAGEM E VOZ DOS PRESENTES AO LEILÃO:

7.1. A entrada da pessoa no recinto do leilão importará na presunção em favor da EMPRESA LEILOEIRA e do PROMOTOR DO EVENTO, sem ônus a estes, ao uso de seus NOMES, IMAGENS e SOM durante a realização do evento, bem como após a ocorrência deste para fins de divulgação do resultado final alcançado. Autorizam, também, a divulgação em periódicos e em site de todas as informações referentes ao leilão, tais como: nome do comprador, do vendedor, do animal ou produto comercializado e o valor efetivo da transação. Finalmente, fica autorizada a gravação de todas as imagens do leilão e dos participantes, bem como a transmissão ao vivo destas por canal fechado de televisão e, ainda, a divulgação de fotos em periódicos e em site próprio da EMPRESA LEILOEIRA.

8. DO CONTRATO DE COMPRA E VENDA:

8.1. Ao final da venda de cada lote a Central Leilões Ltda promoverá a emissão do contrato de compra e venda, bem como das notas promissórias referentes ao leilão, as quais serão assinadas imediatamente pelo vendedor e comprador. As notas fiscais referentes às vendas, que deverão ser emitidas pelos vendedores, bem como a nota fiscal da comissão de compra a ser emitida pela empresa leiloeira, serão efetuadas posteriormente.

8.2. Ficam fazendo parte integrante do contrato de compra e venda todas as regras constantes neste regulamento, bem como outras que forem estabelecidas pelo leiloeiro durante o leilão.

"É proibida a reprodução em parte ou no todo".

LOTE
1000
 INDIVIDUAL

Vendedor: **BOTICÃO NELORE MOCHO**

LINEAR DA BOTICAO

MACHO • NELORE MOCHO PO • BOM 3293 • 17/10/2019
 PESO: **980** kg • PE: **43** cm

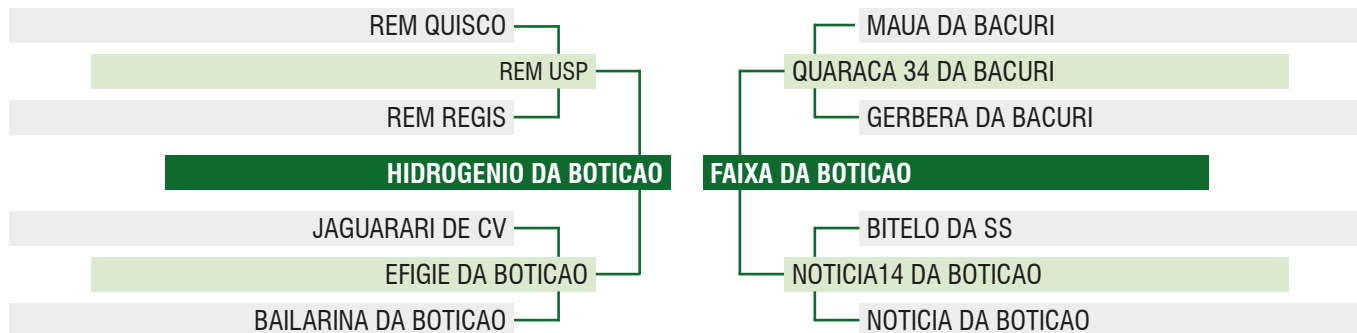

	MGTe	MP120	MP210	DP210	DP365	DP450	DPE365	DPE450	DAOL	DACAB	DIPP	DSTAY	D3P
DEP	22.29	4.20	4.99	17.37	32.35	30.48	0.50	0.47	2.23	0.34	-0.60	61.42	80.43
TOP	5%	3%	4%	1%	0.5%	1%	24%	30%	6%	18%	39%	50%	32%

	iABCZ	PD-ED	PA-ED	PS-ED	PM-EM	TMD	IPP	STAY	PE-365	PE-450	E	P	M	AOL	ACAB
DEP	14.47	12.50	14.75	18.03	3.18	9.89	-1.77	28.93	0.478	1.007	1.185	2.358	1.683	1.456	0.251
DECA	1	1	1	1	1	1	5	7	2	1	2	2	2	2	4

LOTE
01
INDIVIDUAL

Vendedor: **BMT NELORE MOCHO**

IBIS FIV BMT

MACHO • NELORE MOCHO PO • BMT 2853 • 10/09/2019

PESO: **1020** kg • PE: **43** cm

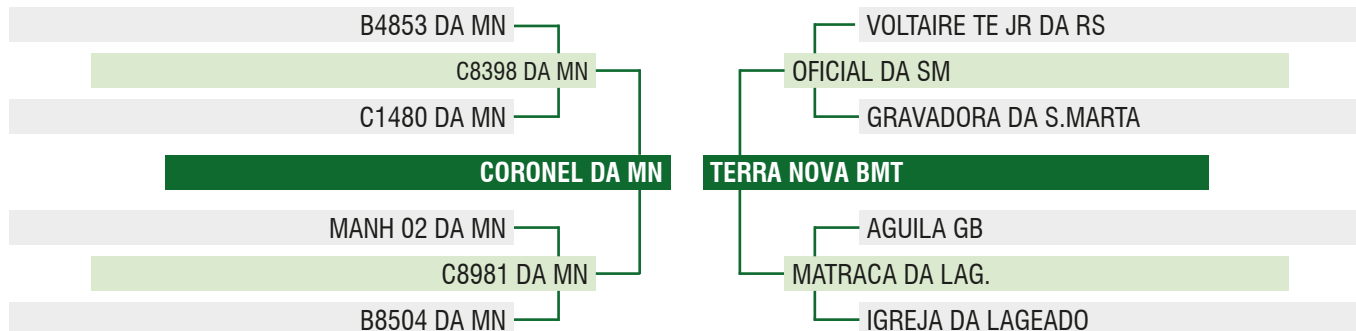

	MGTe	MP120	MP210	DP210	DP365	DP450	DPE365	DPE450	DAOL	DACAB	DIPP	DSTAY	D3P
DEP	20.71	2.82	3.77	10.31	18.63	22.30	1.45	1.89	2.05	-0.01	-1.07	79.61	80.70
TOP	7%	10%	10%	10%	10%	6%	3%	2%	7%	60%	11%	18%	31%

	iABCZ	PD-ED	PA-ED	PS-ED	PM-EM	TMD	IPP	STAY	PE-365	PE-450	E	P	M	AOL	ACAB
DEP	15.48	6.92	10.64	15.08	2.14	6.18	-16.24	32.87	1.124	1.810	2.282	3.183	3.160	2.723	0.412
DECA	1	1	1	1	1	1	1	3	1	1	1	1	1	1	4

LOTE
02
INDIVIDUAL

Vendedor: **BMT NELORE MOCHO**

JAGUNCO BMT

MACHO • NELORE MOCHO PO • BMT 2954 • 24/08/2020

PESO: **760** kg • PE: **41** cm

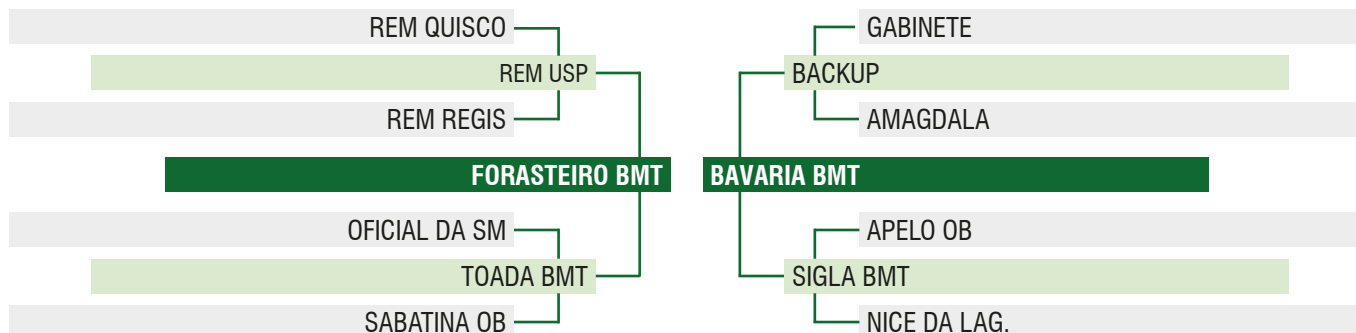

	MGTe	MP120	MP210	DP210	DP365	DP450	DPE365	DPE450	DAOL	DACAB	DIPP	DSTAY	D3P
DEP	14.52	3.38	4.41	5.47	12.08	7.25	0.48	0.34	0.81	0.19	-0.70	80.31	76.81
TOP	20%	6%	6%	32%	27%	48%	25%	36%	18%	29%	32%	17%	46%

	iABCZ	PD-ED	PA-ED	PS-ED	PM-EM	TMD	IPP	STAY	PE-365	PE-450	E	P	M	AOL	ACAB
DEP	12.08	4.90	8.22	10.38	2.87	5.64	-14.56	32.97	0.264	0.482	1.455	3.062	2.287	1.707	-0.310
DECA	1	2	2	2	1	1	1	3	3	3	2	1	1	1	7

LOTE
06
INDIVIDUAL

Vendedor: **BMT NELORE MOCHO**

JARAGUA BMT

MACHO • NELORE MOCHO PO • BMT 2968 • 01/10/2020
PESO: **785** kg • PE: **37** cm

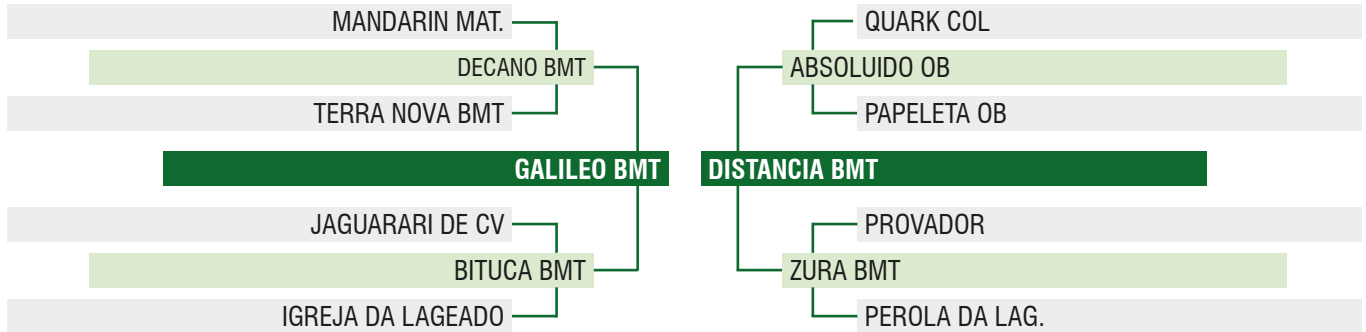

	MGTe	MP120	MP210	DP210	DP365	DP450	DPE365	DPE450	DAOL	DACAB	DIPP	DSTAY	D3P
DEP	17.67	1.81	2.05	11.34	16.49	15.71	0.61	0.54	0.55	0.24	-0.82	74.84	83.05
TOP	13%	26%	33%	7%	14%	18%	20%	27%	22%	25%	24%	25%	22%

	iABCZ	PD-ED	PA-ED	PS-ED	PM-EM	TMD	IPP	STAY	PE-365	PE-450	E	P	M	AOL	ACAB
DEP	7.71	5.58	6.45	11.35	0.55	3.03	-9.14	29.49	0.219	0.314	1.990	3.121	2.022	1.617	-0.201
DECA	3	2	2	1	4	3	3	6	4	4	1	1	2	1	6

LOTE
07
INDIVIDUAL

Vendedor: **BMT NELORE MOCHO**

JACURI BMT

MACHO • NELORE MOCHO PO • BMT 2971 • 04/10/2020
PESO: **685** kg • PE: **37** cm

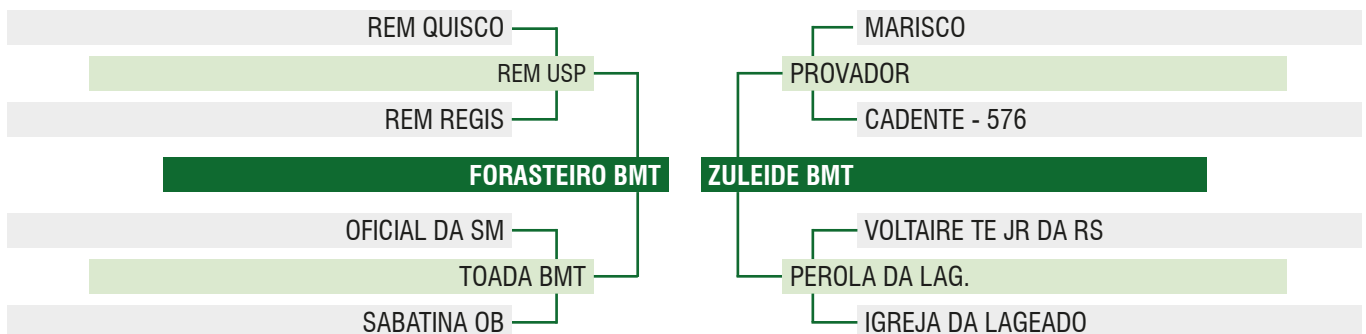

	MGTe	MP120	MP210	DP210	DP365	DP450	DPE365	DPE450	DAOL	DACAB	DIPP	DSTAY	D3P
DEP	15.85	3.55	4.68	6.82	11.11	12.33	0.56	0.20	-0.52	0.26	-0.89	80.13	81.36
TOP	17%	5%	5%	24%	30%	28%	22%	44%	54%	23%	19%	18%	29%

	iABCZ	PD-ED	PA-ED	PS-ED	PM-EM	TMD	IPP	STAY	PE-365	PE-450	E	P	M	AOL	ACAB
DEP	11.01	4.51	6.80	8.99	2.67	5.00	-11.22	33.39	0.326	0.641	1.473	3.082	2.102	0.046	-0.514
DECA	2	2	2	2	1	1	2	2	3	2	2	1	2	6	7

LOTE
08
 INDIVIDUAL

 Vendedor: **BMT NELORE MOCHO**

JARGAO BMT

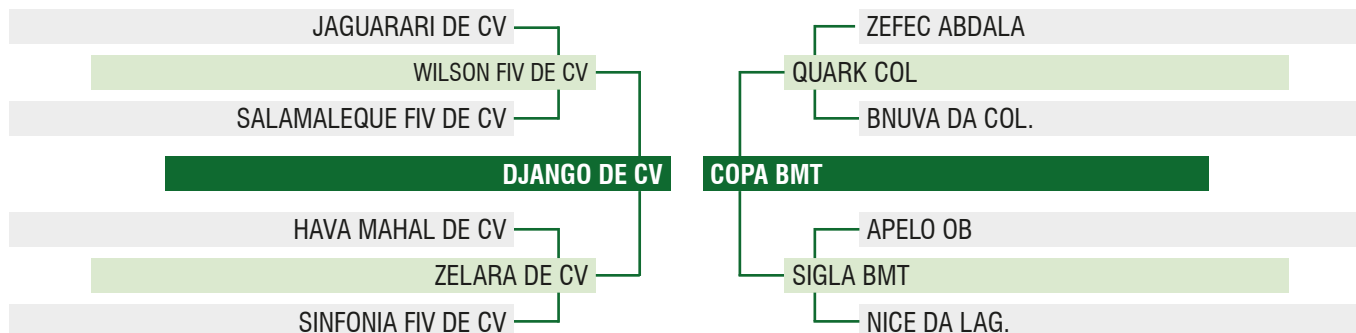
 MACHO • NELORE MOCHO PO • BMT 2980 • 12/10/2020
 PESO: **830** kg • PE: **38** cm

	MGTe	MP120	MP210	DP210	DP365	DP450	DPE365	DPE450	DAOL	DACAB	DIPP	DSTAY	D3P
DEP	17.48	0.97	1.44	7.35	16.19	13.87	0.74	0.79	1.84	0.67	-0.85	80.47	81.41
TOP	13%	46%	45%	21%	15%	23%	15%	19%	8%	6%	22%	17%	29%

	iABCZ	PD-ED	PA-ED	PS-ED	PM-EM	TMD	IPP	STAY	PE-365	PE-450	E	P	M	AOL	ACAB
DEP	5.63	3.19	5.19	4.07	-0.16	1.24	-7.41	31.71	0.290	0.423	0.301	4.762	3.709	1.906	2.629
DECA	4	3	3	4	6	5	3	4	3	3	5	1	1	1	1

 LOTE
09
 INDIVIDUAL

 Vendedor: **BMT NELORE MOCHO**

JALES BMT

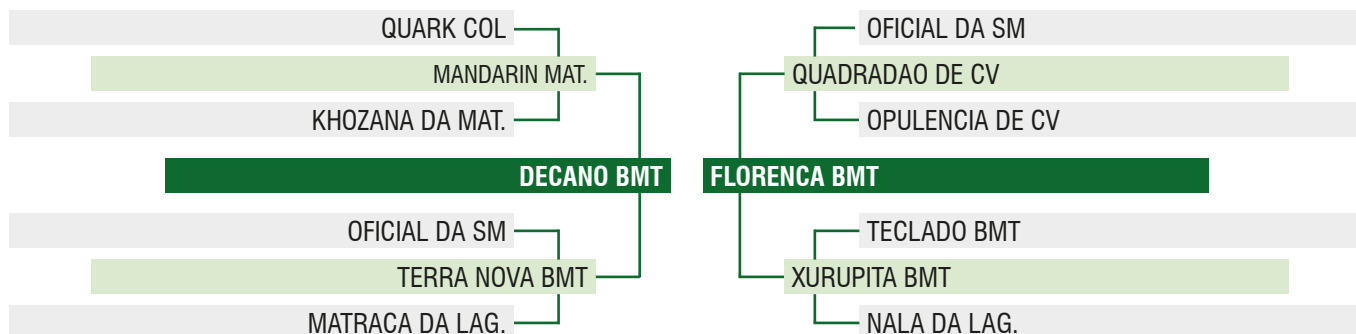
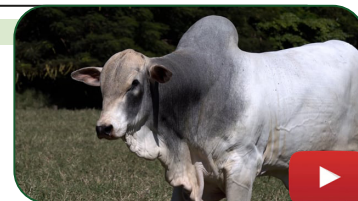
 MACHO • NELORE MOCHO PO • BMT 2985 • 01/11/2020
 PESO: **810** kg • PE: **39** cm

	MGTe	MP120	MP210	DP210	DP365	DP450	DPE365	DPE450	DAOL	DACAB	DIPP	DSTAY	D3P
DEP	16.42	2.63	3.13	10.02	12.03	14.51	0.87	1.08	1.35	0.27	-0.26	74.09	72.62
TOP	15%	12%	16%	10%	27%	21%	12%	11%	12%	23%	66%	26%	61%

	iABCZ	PD-ED	PA-ED	PS-ED	PM-EM	TMD	IPP	STAY	PE-365	PE-450	E	P	M	AOL	ACAB
DEP	7.80	4.65	4.87	6.17	2.92	6.11	1.70	31.55	0.588	0.390	1.348	1.518	2.258	1.252	0.107
DECA	3	2	3	3	1	1	7	4	1	3	2	3	1	2	5

LOTE
10
 INDIVIDUAL

 Vendedor: **BMT NELORE MOCHO**

JEQUIE BMT

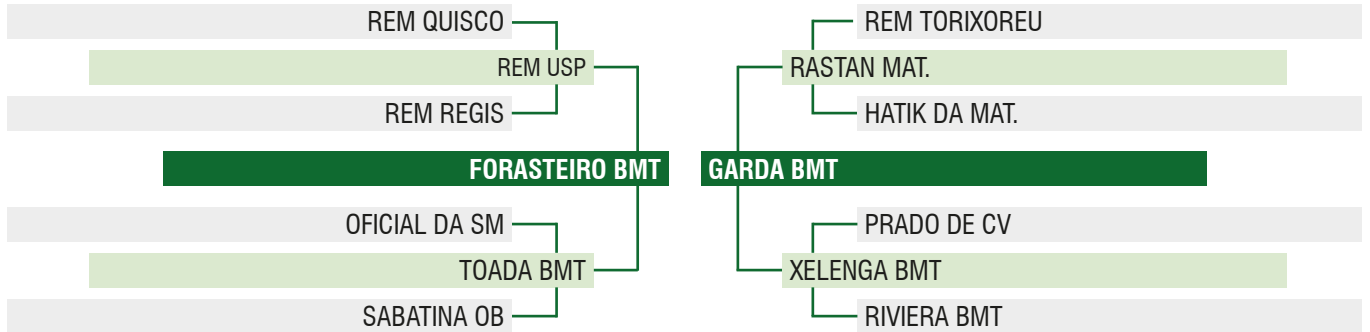
 MACHO • NELORE MOCHO PO • BMT 2987 • 02/11/2020
 PESO: **700** kg • PE: **36** cm

	MGTe	MP120	MP210	DP210	DP365	DP450	DPE365	DPE450	DAOL	DACAB	DIPP	DSTAY	D3P
DEP	14.25	4.18	5.27	5.48	11.86	15.82	0.22	-0.09	-0.26	0.07	0.05	4.33	77.26
TOP	21%	3%	3%	32%	27%	17%	41%	68%	45%	44%	51%	41%	22%

	iABCZ	PD-ED	PA-ED	PS-ED	PM-EM	TMD	IPP	STAY	PE-365	PE-450	E	P	M	AOL	ACAB
DEP	9.95	4.43	6.56	8.88	2.96	5.42	-10.26	31.91	0.223	0.176	1.033	4.703	4.416	-0.013	-0.731
DECA	2	2	2	2	1	1	2	4	4	5	3	1	1	6	8

 LOTE
11
 INDIVIDUAL

 Vendedor: **BMT NELORE MOCHO**

JIVAGO BMT

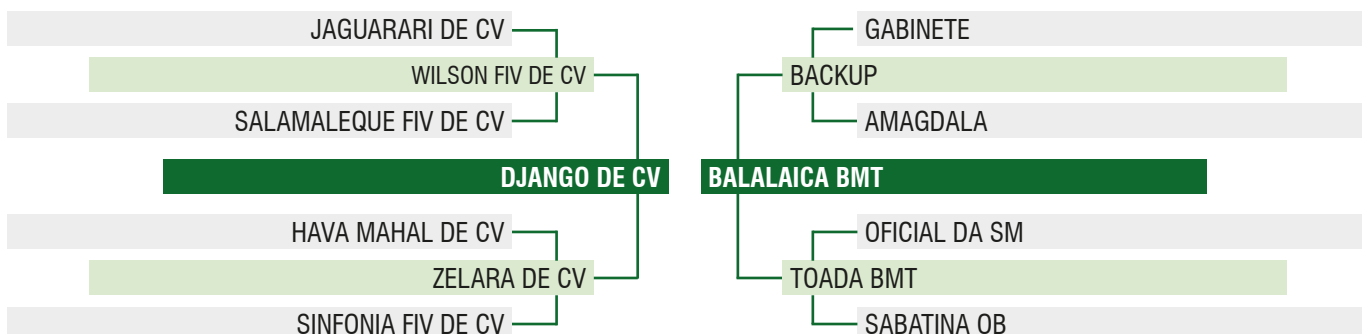
 MACHO • NELORE MOCHO PO • BMT 2990 • 09/11/2020
 PESO: **800** kg • PE: **37** cm

	MGTe	MP120	MP210	DP210	DP365	DP450	DPE365	DPE450	DAOL	DACAB	DIPP	DSTAY	D3P
DEP	24.62	2.72	3.62	12.05	25.15	31.19	0.53	0.53	3.80	0.22	-0.98	86.20	79.81
TOP	3%	11%	11%	6%	3%	1%	23%	28%	1%	27%	15%	9%	35%

	iABCZ	PD-ED	PA-ED	PS-ED	PM-EM	TMD	IPP	STAY	PE-365	PE-450	E	P	M	AOL	ACAB
DEP	16.20	4.87	10.48	16.11	2.87	5.97	-26.28	33.61	0.447	0.623	0.185	4.107	2.867	3.627	1.769
DECA	1	2	1	1	1	1	1	2	2	2	6	1	1	1	1

LOTE
12
 INDIVIDUAL

 Vendedor: **BMT NELORE MOCHO**

JONAS BMT

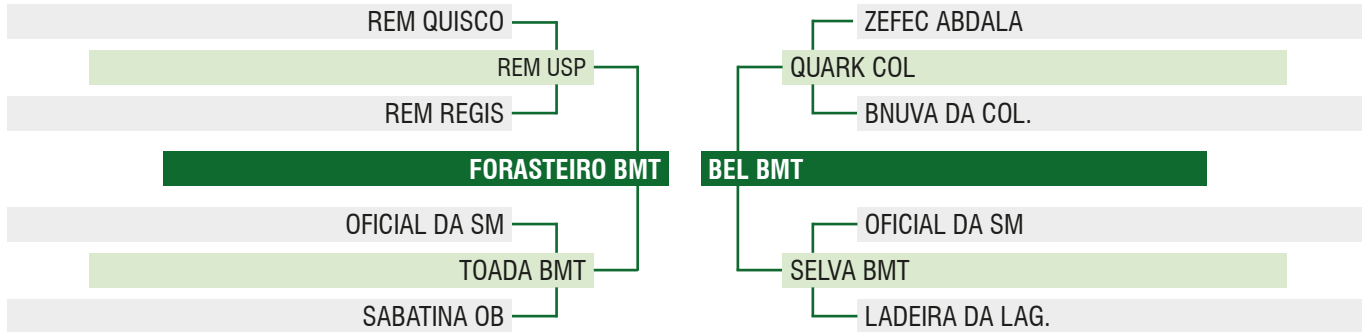
 MACHO • NELORE MOCHO PO • BMT 2992 • 15/11/2020
 PESO: **710** kg • PE: **37** cm

	MGTe	MP120	MP210	DP210	DP365	DP450	DPE365	DPE450	DAOL	DACAB	DIPP	DSTAY	D3P
DEP	15.88	5.10	6.51	4.66	12.36	16.72	0.79	1.07	-0.12	0.24	-0.75	79.25	75.55
TOP	17%	1%	2%	38%	26%	15%	14%	12%	41%	25%	28%	19%	51%

	iABCZ	PD-ED	PA-ED	PS-ED	PM-EM	TMD	IPP	STAY	PE-365	PE-450	E	P	M	AOL	ACAB
DEP	9.51	2.93	7.28	9.41	4.92	7.14	-6.09	29.88	0.588	0.757	1.271	4.023	3.242	0.498	-0.420
DECA	2	4	2	2	1	1	4	6	1	2	2	1	1	4	7

 LOTE
13
 INDIVIDUAL

 Vendedor: **BMT NELORE MOCHO**

JUPITER BMT

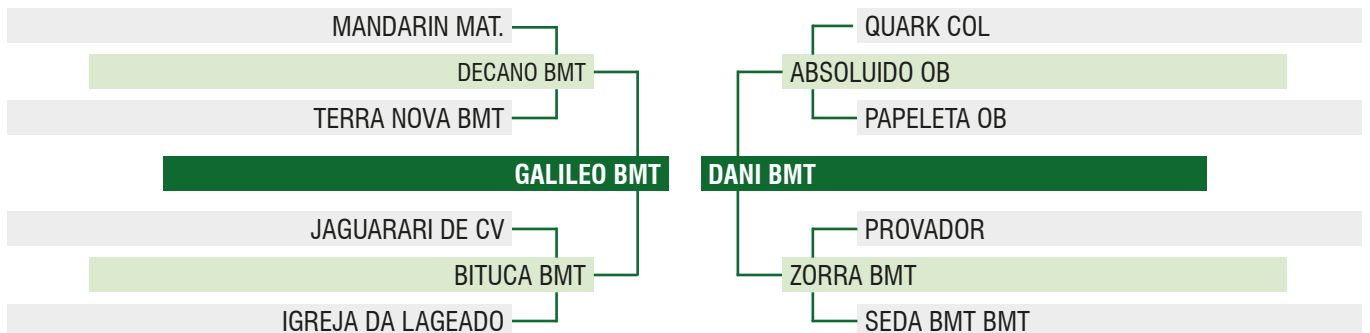
 MACHO • NELORE MOCHO PO • BMT 2995 • 23/11/2020
 PESO: **760** kg • PE: **39** cm

	MGTe	MP120	MP210	DP210	DP365	DP450	DPE365	DPE450	DAOL	DACAB	DIPP	DSTAY	D3P
DEP	11.70	0.90	0.56	5.71	7.60	8.53	0.39	0.34	1.38	-0.43	-0.19	74.13	70.18
TOP	29%	48%	63%	31%	45%	42%	30%	36%	12%	98%	71%	26%	68%

	iABCZ	PD-ED	PA-ED	PS-ED	PM-EM	TMD	IPP	STAY	PE-365	PE-450	E	P	M	AOL	ACAB
DEP	4.42	4.61	3.11	8.06	1.35	3.22	3.36	28.49	0.556	0.353	0.235	3.707	2.541	2.403	-1.644
DECA	4	2	4	2	3	3	7	7	1	3	6	1	1	1	10

LOTE
14
INDIVIDUAL

Vendedor: **BMT NELORE MOCHO**

JUNCO BMT

MACHO • NELORE MOCHO PO • BMT 2996 • 23/11/2020
PESO: **800** kg • PE: **40** cm

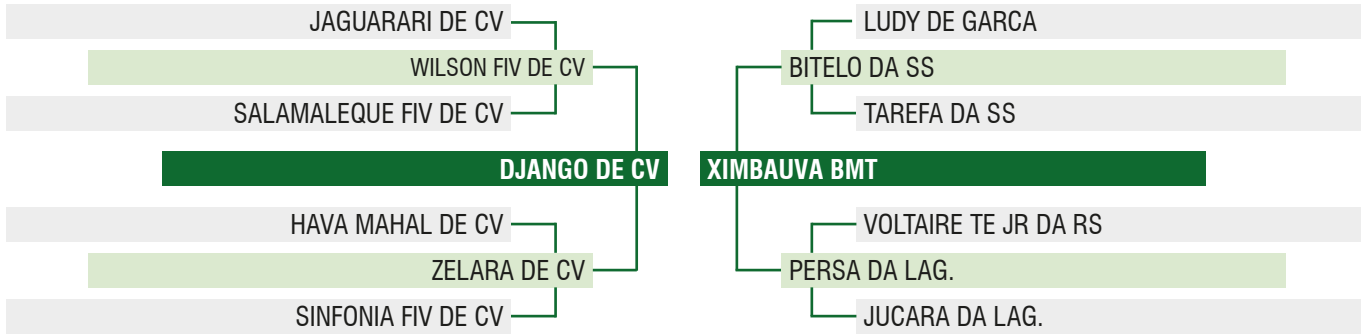

	MGTe	MP120	MP210	DP210	DP365	DP450	DPE365	DPE450	DAOL	DACAB	DIPP	DSTAY	D3P
DEP	13.50	2.14	2.97	4.40	15.21	13.31	0.47	0.44	0.43	0.23	-0.79	70.75	80.64
TOP	23%	19%	18%	40%	17%	24%	26%	31%	24%	26%	25%	31%	31%

	iABCZ	PD-ED	PA-ED	PS-ED	PM-EM	TMD	IPP	STAY	PE-365	PE-450	E	P	M	AOL	ACAB
DEP	10.39	3.73	8.53	11.63	2.25	5.16	-17.65	29.73	0.395	0.448	0.551	2.206	1.667	1.234	1.017
DECA	2	3	1	1	1	1	1	6	2	3	4	2	2	2	2

LOTE
15
INDIVIDUAL

Vendedor: **BMT NELORE MOCHO**

JUNDIAI BMT

MACHO • NELORE MOCHO PO • BMT 2997 • 25/11/2020
PESO: **740** kg • PE: **38** cm

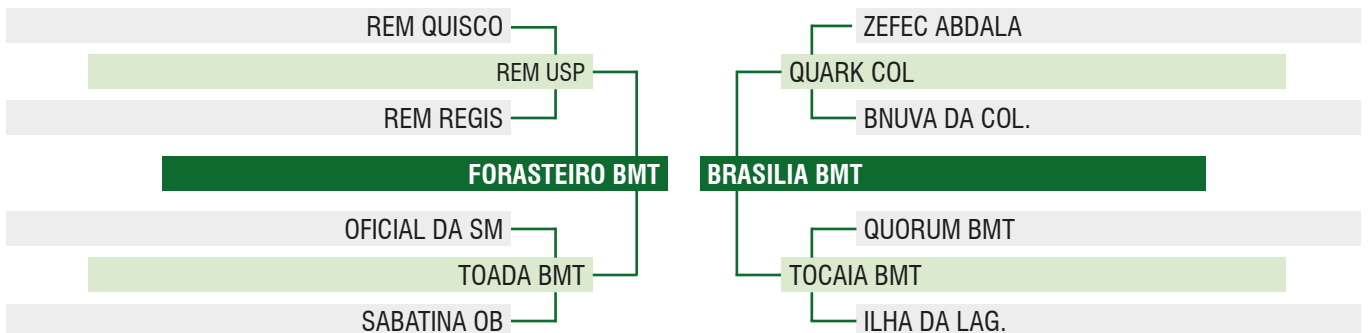

	MGTe	MP120	MP210	DP210	DP365	DP450	DPE365	DPE450	DAOL	DACAB	DIPP	DSTAY	D3P
DEP	13.01	3.18	4.19	3.63	10.26	11.19	0.85	1.08	-0.11	0.14	-0.77	77.98	72.30
TOP	25%	7%	7%	46%	33%	31%	12%	11%	40%	35%	27%	21%	62%

	iABCZ	PD-ED	PA-ED	PS-ED	PM-EM	TMD	IPP	STAY	PE-365	PE-450	E	P	M	AOL	ACAB
DEP	9.55	1.96	5.82	7.36	3.28	4.74	-8.78	32.92	0.594	0.784	0.777	2.696	2.395	0.783	-0.606
DECA	2	5	3	3	1	1	3	3	1	1	4	1	1	3	8

LOTE
16
 INDIVIDUAL

 Vendedor: **BMT NELORE MOCHO**

JAMELÃO BMT

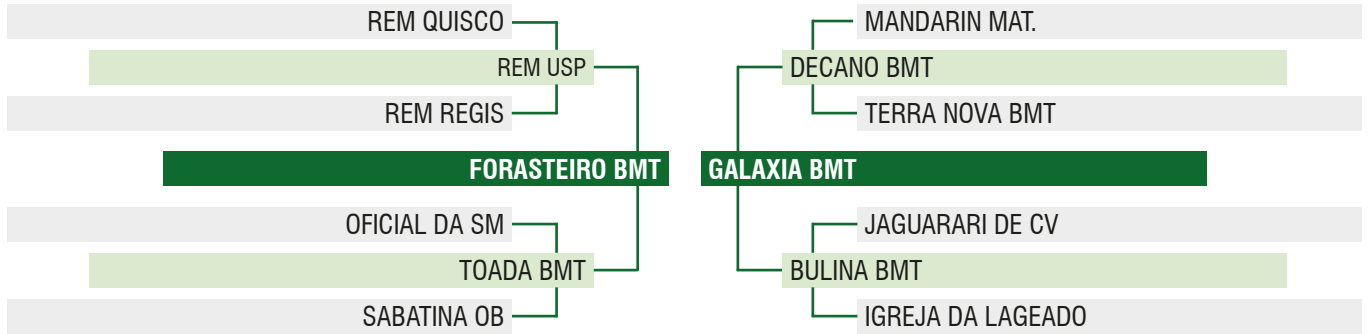
 MACHO • NELORE MOCHO PO • BMT 2999 • 26/11/2020
 PESO: **690** kg • PE: **40** cm

	MGTe	MP120	MP210	DP210	DP365	DP450	DPE365	DPE450	DAOL	DACAB	DIPP	DSTAY	D3P
DEP	14.76	3.39	4.26	5.92	12.75	11.12	0.83	1.32	0.65	0.29	-0.58	75.49	76.15
TOP	20%	6%	7%	29%	24%	32%	13%	7%	20%	21%	41%	24%	49%

	iABCZ	PD-ED	PA-ED	PS-ED	PM-EM	TMD	IPP	STAY	PE-365	PE-450	E	P	M	AOL	ACAB
DEP	8.70	4.75	5.70	7.83	3.17	5.82	-5.54	30.73	0.418	0.699	0.694	3.017	2.098	0.910	-0.392
DECA	2	2	3	2	1	1	4	5	2	2	4	1	2	3	7

 LOTE
19
 INDIVIDUAL

 Vendedor: **BMT NELORE MOCHO**

JOGADOR BMT

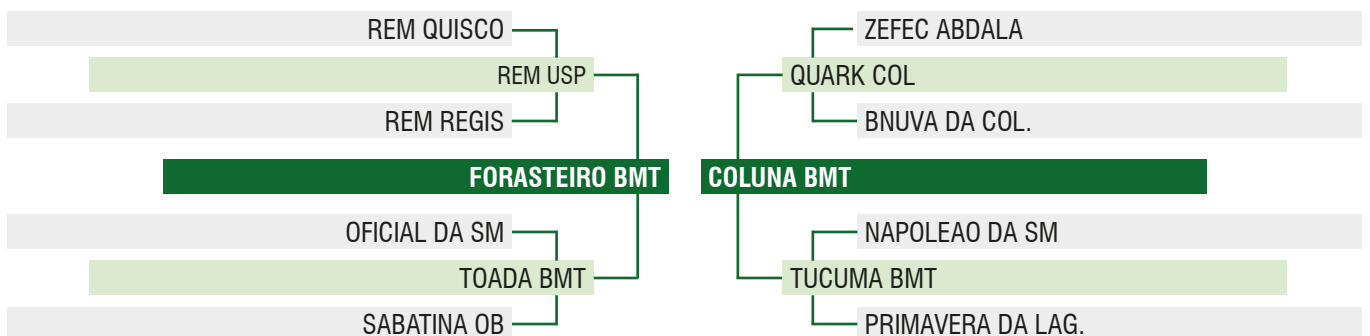
 MACHO • NELORE MOCHO PO • BMT 3004 • 04/12/2020
 PESO: **700** kg • PE: **39** cm

	MGTe	MP120	MP210	DP210	DP365	DP450	DPE365	DPE450	DAOL	DACAB	DIPP	DSTAY	D3P
DEP	15.27	4.56	6.07	4.12	13.93	13.40	1.11	1.31	0.28	-0.01	-0.69	79.57	76.10
TOP	18%	2%	2%	42%	21%	24%	7%	7%	27%	60%	32%	18%	49%

	iABCZ	PD-ED	PA-ED	PS-ED	PM-EM	TMD	IPP	STAY	PE-365	PE-450	E	P	M	AOL	ACAB
DEP	11.51	3.26	9.25	10.38	4.14	6.77	-7.53	31.51	0.940	1.039	1.033	2.843	2.168	1.354	-0.854
DECA	1	3	1	2	1	1	3	4	1	1	3	1	1	2	9

LOTE
20
 INDIVIDUAL

 Vendedor: **BMT NELORE MOCHO**

JAU BMT

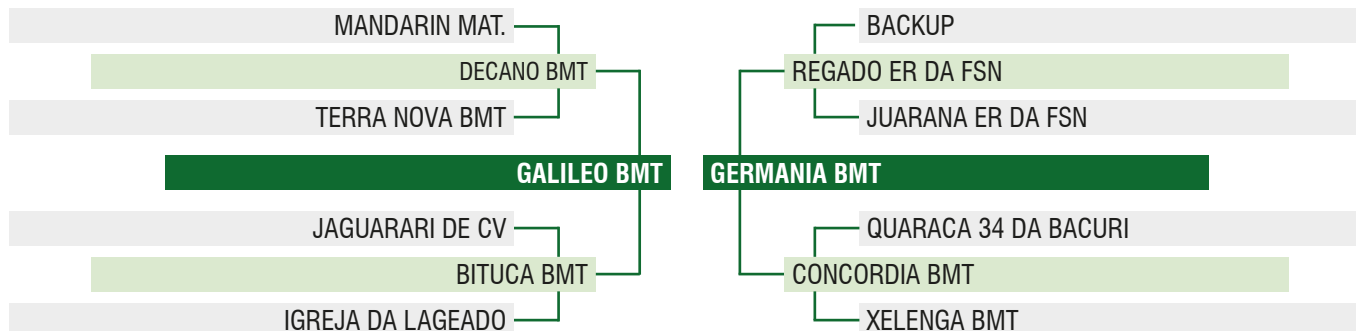
 MACHO • NELORE MOCHO PO • BMT 3005 • 13/12/2020
 PESO: **760** kg • PE: **37** cm

	MGTe	MP120	MP210	DP210	DP365	DP450	DPE365	DPE450	DAOL	DACAB	DIPP	DSTAY	D3P
DEP	16.65	2.29	2.87	7.78	19.19	18.50	0.72	0.67	0.90	0.26	-0.41	79.76	72.89
TOP	15%	17%	20%	19%	9%	12%	16%	22%	17%	23%	54%	18%	60%

	iABCZ	PD-ED	PA-ED	PS-ED	PM-EM	TMD	IPP	STAY	PE-365	PE-450	E	P	M	AOL	ACAB
DEP	11.56	4.73	8.22	11.26	1.40	4.10	-8.21	34.63	0.424	0.285	0.989	2.151	1.399	1.714	0.588
DECA	1	2	2	1	3	2	3	2	2	4	3	2	3	1	3

 LOTE
21
 INDIVIDUAL

 Vendedor: **BMT NELORE MOCHO**

JOGRAL BMT

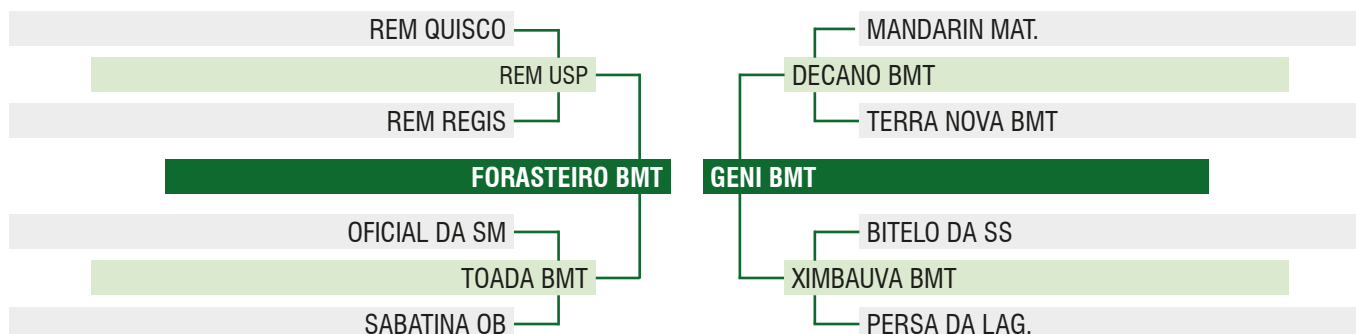
 MACHO • NELORE MOCHO PO • BMT 3006 • 16/12/2020
 PESO: **730** kg • PE: **39** cm

	MGTe	MP120	MP210	DP210	DP365	DP450	DPE365	DPE450	DAOL	DACAB	DIPP	DSTAY	D3P
DEP	15.28	4.04	5.23	6.63	17.24	17.52	0.73	1.03	0.02	0.13	-0.57	73.17	75.03
TOP	18%	3%	3%	25%	13%	14%	16%	12%	34%	36%	41%	27%	53%

	iABCZ	PD-ED	PA-ED	PS-ED	PM-EM	TMD	IPP	STAY	PE-365	PE-450	E	P	M	AOL	ACAB
DEP	10.57	5.19	9.07	11.79	3.94	7.38	-5.90	29.74	0.523	0.849	1.587	2.148	2.341	0.670	-1.001
DECA	2	2	1	1	1	1	4	6	2	1	1	2	1	4	9

LOTE
22
 INDIVIDUAL

 Vendedor: **BMT NELORE MOCHO**

JUSTO BMT

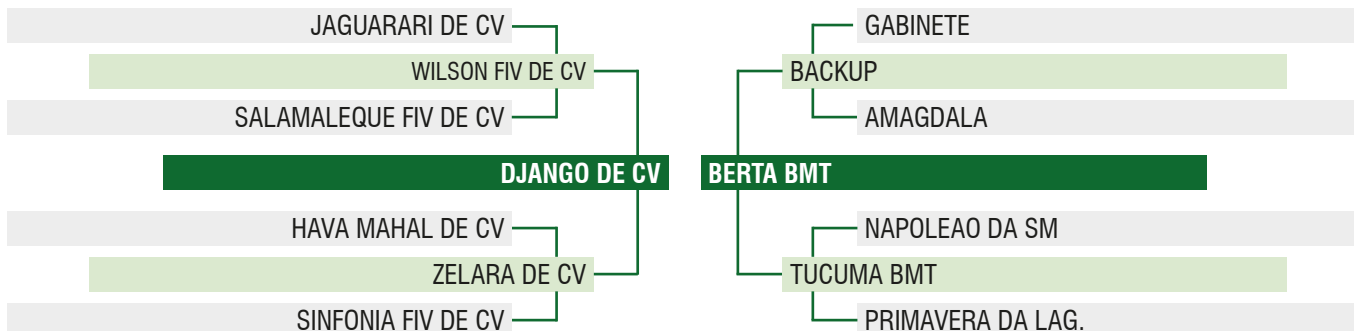
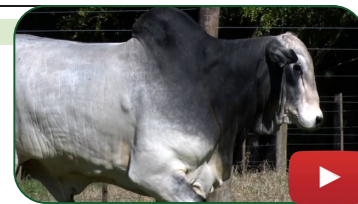
 MACHO • NELORE MOCHO PO • BMT 3007 • 17/12/2020
 PESO: **780** kg • PE: **35** cm

	MGTe	MP120	MP210	DP210	DP365	DP450	DPE365	DPE450	DAOL	DACAB	DIPP	DSTAY	D3P
DEP	20.21	1.13	1.56	7.57	18.00	19.71	0.25	0.13	3.14	0.35	-1.10	83.16	87.22
TOP	8%	42%	42%	20%	11%	10%	39%	49%	3%	18%	9%	13%	9%

	iABCZ	PD-ED	PA-ED	PS-ED	PM-EM	TMD	IPP	STAY	PE-365	PE-450	E	P	M	AOL	ACAB
DEP	13.77	5.64	8.07	14.36	1.07	4.52	-20.48	34.41	0.124	0.206	0.106	3.249	2.755	3.740	2.912
DECA	1	2	2	1	3	2	1	2	5	4	6	1	1	1	1

 LOTE
23
 INDIVIDUAL

 Vendedor: **BMT NELORE MOCHO**

JURERE BMT

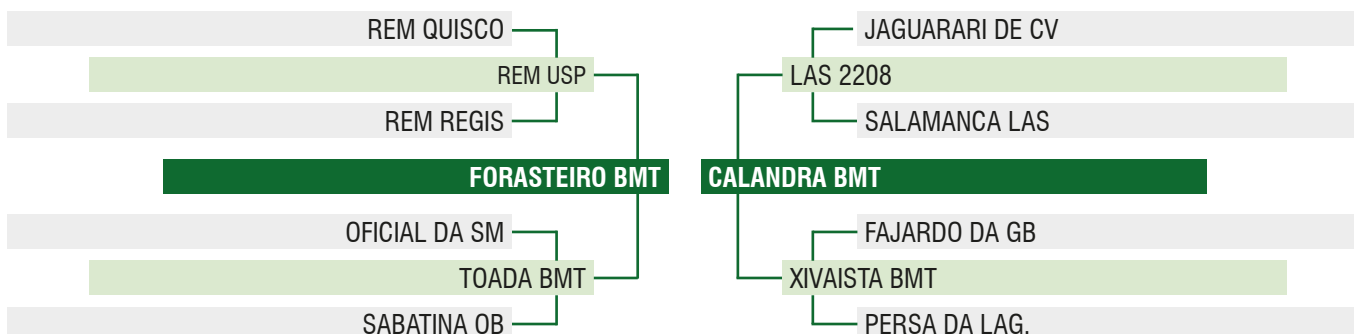
 MACHO • NELORE MOCHO PO • BMT 3018 • 30/12/2020
 PESO: **750** kg • PE: **40** cm

	MGTe	MP120	MP210	DP210	DP365	DP450	DPE365	DPE450	DAOL	DACAB	DIPP	DSTAY	D3P
DEP	14.60	3.30	4.43	5.84	14.60	14.33	0.76	1.19	0.18	0.22	-0.81	74.07	76.03
TOP	20%	6%	6%	30%	19%	21%	15%	9%	29%	27%	24%	26%	49%

	iABCZ	PD-ED	PA-ED	PS-ED	PM-EM	TMD	IPP	STAY	PE-365	PE-450	E	P	M	AOL	ACAB
DEP	9.91	4.94	8.77	11.51	2.99	5.92	-11.44	29.23	0.317	0.822	1.257	2.364	1.835	0.824	-0.207
DECA	2	2	1	1	1	1	2	7	3	1	2	2	2	3	6

LOTE
25
 INDIVIDUAL

 Vendedor: **BMT NELORE MOCHO**

JARDIM BMT

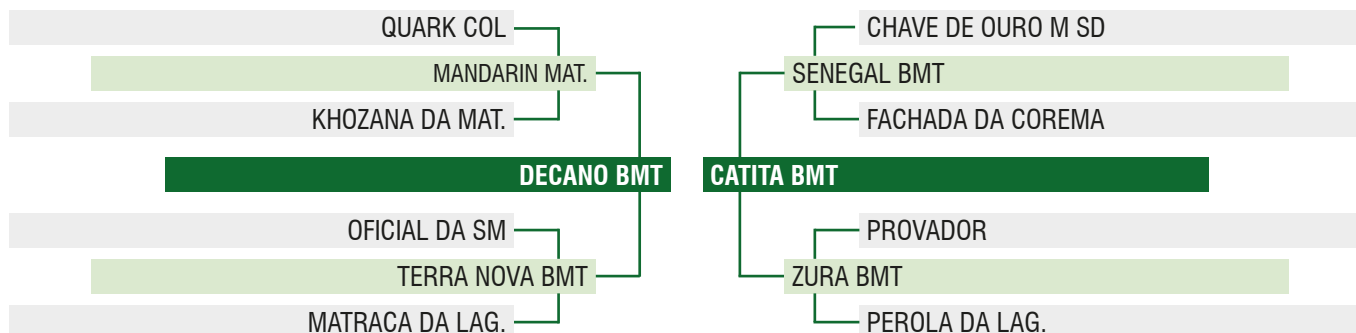
 MACHO • NELORE MOCHO PO • BMT 3022 • 19/04/2021
 PESO: **680** kg • PE: **35** cm

	MGTe	MP120	MP210	DP210	DP365	DP450	DPE365	DPE450	DAOL	DACAB	DIPP	DSTAY	D3P
DEP	14.94	2.23	2.76	9.47	18.45	19.46	0.57	0.79	0.39	0.48	-0.29	68.91	69.24
TOP	19%	18%	21%	12%	10%	10%	21%	19%	25%	12%	64%	34%	70%

	iABCZ	PD-ED	PA-ED	PS-ED	PM-EM	TMD	IPP	STAY	PE-365	PE-450	E	P	M	AOL	ACAB
DEP	10.83	7.66	9.87	12.15	1.93	6.40	-7.55	30.40	0.215	0.283	1.227	1.168	1.376	1.331	1.343
DECA	2	1	1	1	2	1	3	5	4	4	2	3	3	2	1

 LOTE
27
 INDIVIDUAL

 Vendedor: **BMT NELORE MOCHO**

KENT BMT

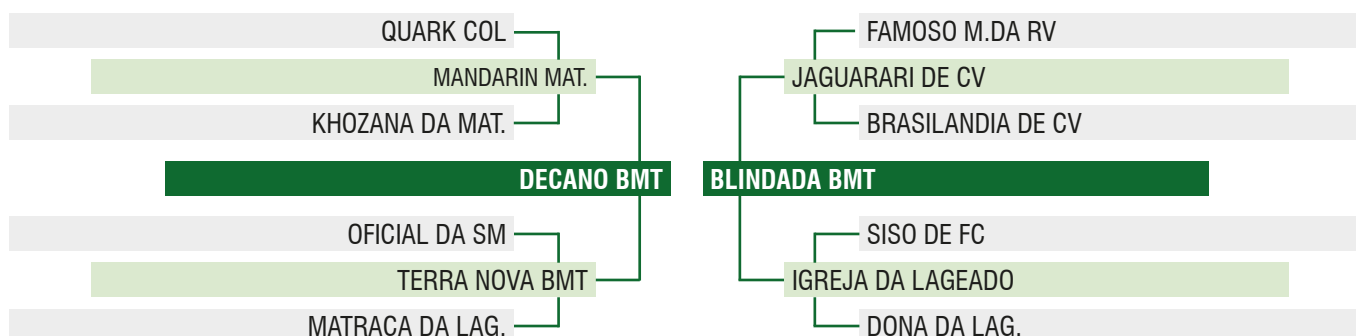
 MACHO • NELORE MOCHO PO • BMT 3026 • 06/08/2021
 PESO: **660** kg • PE: **35** cm

	MGTe	MP120	MP210	DP210	DP365	DP450	DPE365	DPE450	DAOL	DACAB	DIPP	DSTAY	D3P
DEP	17.99	2.21	2.54	8.16	19.43	23.10	1.05	1.44	1.88	0.17	-0.42	74.40	75.71
TOP	12%	18%	24%	17%	9%	5%	8%	6%	8%	31%	53%	25%	50%

	iABCZ	PD-ED	PA-ED	PS-ED	PM-EM	TMD	IPP	STAY	PE-365	PE-450	E	P	M	AOL	ACAB
DEP	7.90	4.97	5.02	8.03	2.16	4.71	-3.75	30.93	0.415	0.224	0.830	2.222	1.856	2.217	0.339
DECA	3	2	3	2	1	1	5	5	2	4	3	2	2	1	4

LOTE
29
 INDIVIDUAL

 Vendedor: **BMT NELORE MOCHO**

KREMER BMT

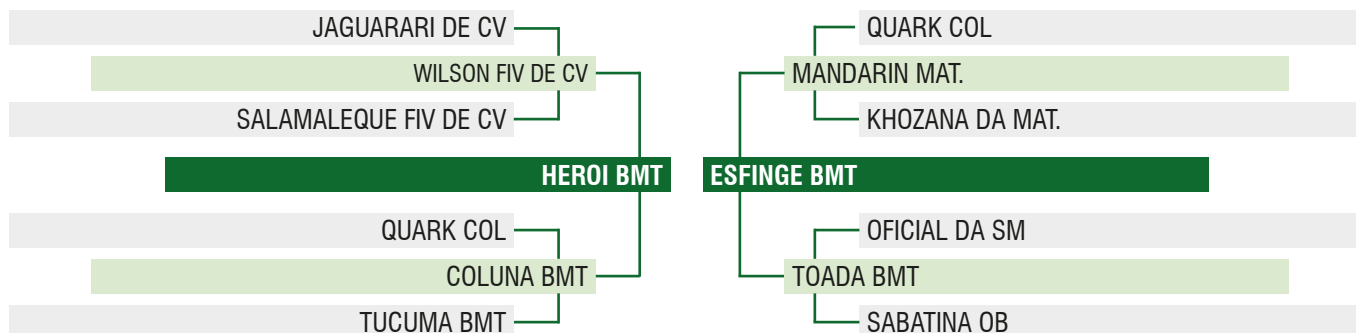
 MACHO • NELORE MOCHO PO • BMT 3035 • 05/09/2021
 PESO: **650** kg • PE: **35** cm

	MGTe	MP120	MP210	DP210	DP365	DP450	DPE365	DPE450	DAOL	DACAB	DIPP	DSTAY	D3P
DEP	24.32	0.91	1.06	15.53	24.71	28.10	0.63	0.86	3.26	0.36	-0.77	85.00	79.89
TOP	3%	48%	53%	2%	3%	2%	19%	17%	2%	17%	27%	10%	34%

	iABCZ	PD-ED	PA-ED	PS-ED	PM-EM	TMD	IPP	STAY	PE-365	PE-450	E	P	M	AOL	ACAB
DEP	14.51	8.72	14.24	19.46	0.55	5.38	-23.98	28.90	0.335	0.710	1.650	4.246	4.983	3.765	2.871
DECA	1	1	1	1	4	1	1	7	3	2	1	1	1	1	1

 LOTE
32
 INDIVIDUAL

 Vendedor: **BMT NELORE MOCHO**

KONG FIV BMT

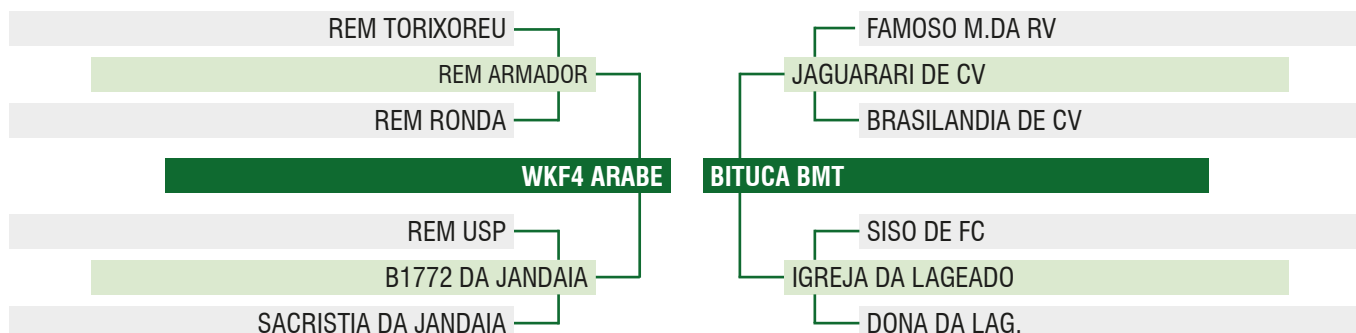
 MACHO • NELORE MOCHO PO • BMT 3044 • 16/09/2021
 PESO: **690** kg • PE: **37** cm

	MGTe	MP120	MP210	DP210	DP365	DP450	DPE365	DPE450	DAOL	DACAB	DIPP	DSTAY	D3P
DEP	20.41	3.12	3.85	11.60	21.88	20.82	0.98	0.92	2.97	0.24	-0.76	71.32	81.70
TOP	7%	7%	10%	7%	6%	8%	9%	15%	3%	25%	27%	30%	27%

	iABCZ	PD-ED	PA-ED	PS-ED	PM-EM	TMD	IPP	STAY	PE-365	PE-450	E	P	M	AOL	ACAB
DEP	17.94	9.22	13.93	20.48	1.51	6.17	-21.28	33.26	0.586	0.724	2.008	2.965	1.595	3.505	0.540
DECA	1	1	1	1	2	1	1	3	1	2	1	1	2	1	3

LOTE
36
 INDIVIDUAL

 Vendedor: **BMT NELORE MOCHO**

KAIK FIV BMT

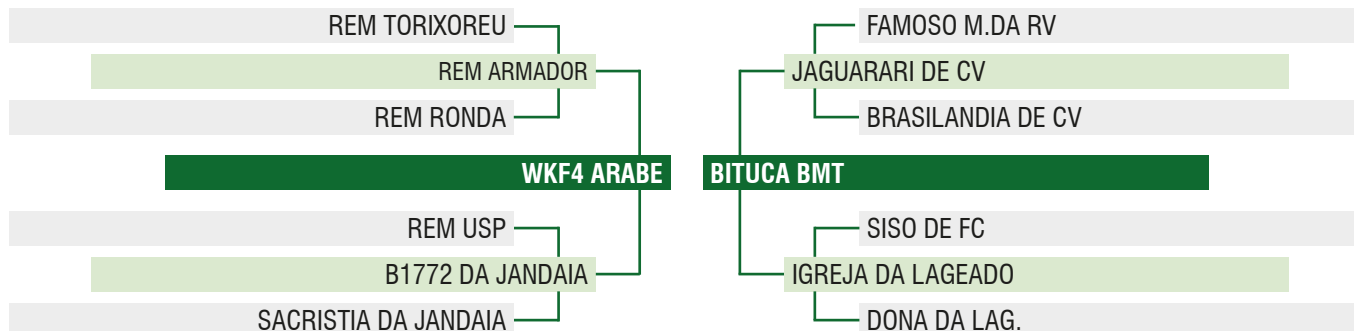
 MACHO • NELORE MOCHO PO • BMT 3050 • 23/09/2021
 PESO: **610** kg • PE: **34** cm

	MGTe	MP120	MP210	DP210	DP365	DP450	DPE365	DPE450	DAOL	DACAB	DIPP	DSTAY	D3P
DEP	20.41	3.12	3.85	11.60	21.88	20.82	0.98	0.99	2.97	0.24	-0.76	71.32	81.70
TOP	7%	7%	10%	7%	6%	8%	9%	13%	3%	25%	27%	30%	27%

	iABCZ	PD-ED	PA-ED	PS-ED	PM-EM	TMD	IPP	STAY	PE-365	PE-450	E	P	M	AOL	ACAB
DEP	17.94	9.22	13.93	20.48	1.51	6.17	-21.28	33.26	0.586	0.724	2.008	2.965	1.595	3.505	0.540
DECA	1	1	1	1	2	1	1	3	1	2	1	1	2	1	3

 LOTE
39
 INDIVIDUAL

 Vendedor: **BMT NELORE MOCHO**

KARTAGO BMT

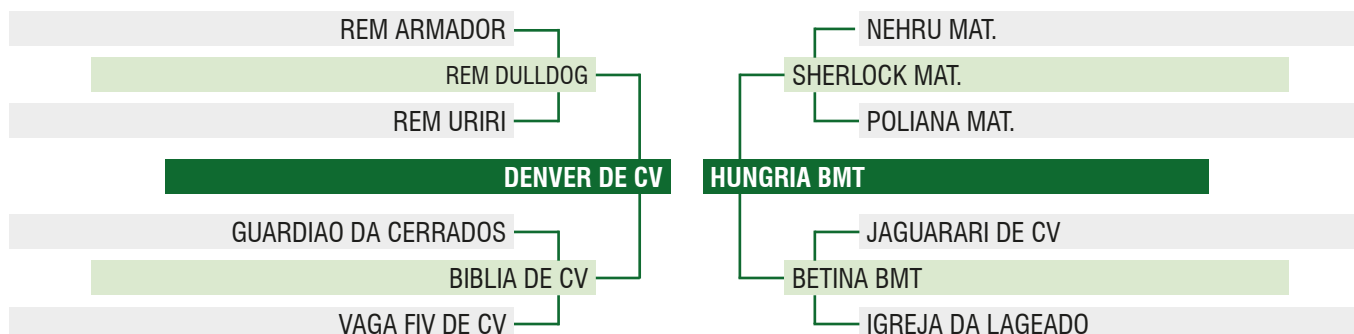
 MACHO • NELORE MOCHO PO • BMT 3068 • 03/10/2021
 PESO: **610** kg • PE: **37** cm

	MGTe	MP120	MP210	DP210	DP365	DP450	DPE365	DPE450	DAOL	DACAB	DIPP	DSTAY	D3P
DEP	24.48	0.59	0.47	15.91	25.66	24.19	1.41	1.19	1.73	0.42	-0.77	91.57	81.63
TOP	3%	57%	65%	2%	3%	4%	3%	9%	9%	14%	27%	2%	28%

	iABCZ	PD-ED	PA-ED	PS-ED	PM-EM	TMD	IPP	STAY	PE-365	PE-450	E	P	M	AOL	ACAB
DEP	14.74	9.24	12.19	16.10	0.78	5.96	0.81	35.98	0.610	1.050	0.900	4.650	3.590	1.830	1.680
DECA	1	1	1	1	4	1	6	1	1	1	3	1	1	1	1

LOTE
41
INDIVIDUAL

Vendedor: **BMT NELORE MOCHO**

KRIVO BMT

MACHO • NELORE MOCHO PO • BMT 3075 • 06/10/2021
PESO: **580** kg • PE: **34** cm

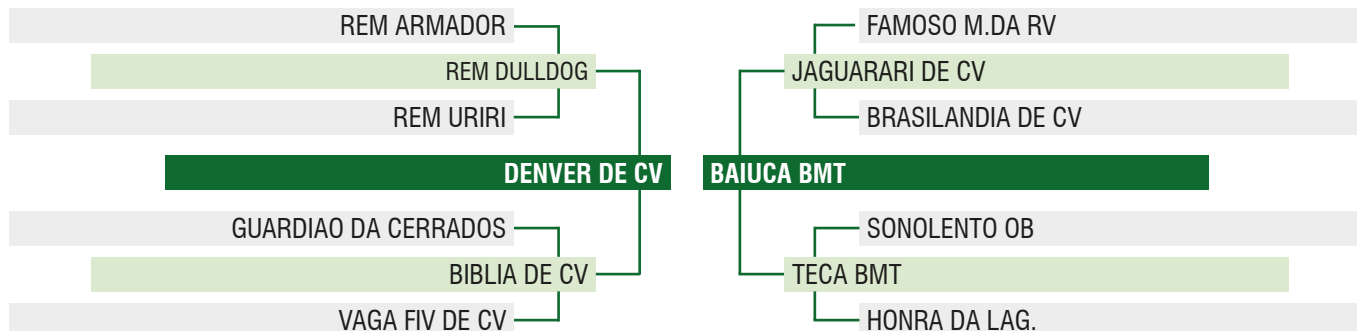

	MGTe	MP120	MP210	DP210	DP365	DP450	DPE365	DPE450	DAOL	DACAB	DIPP	DSTAY	D3P
DEP	18.10	2.37	3.37	9.29	15.54	13.54	0.60	0.57	1.03	0.40	-0.70	83.81	79.55
TOP	12%	16%	14%	13%	16%	24%	20%	26%	15%	15%	32%	12%	36%

	iABCZ	PD-ED	PA-ED	PS-ED	PM-EM	TMD	IPP	STAY	PE-365	PE-450	E	P	M	AOL	ACAB
DEP	14.13	6.09	9.73	14.58	2.24	6.16	-7.71	34.99	0.550	0.837	1.123	3.128	2.130	2.322	1.515
DECA	1	1	1	1	1	1	3	1	1	1	2	1	1	1	1

LOTE
43
INDIVIDUAL

Vendedor: **BOTICÃO NELORE MOCHO**

MECENAS DA BOTICAO

MACHO • NELORE MOCHO PO • BOM 3356 • 06/08/2020
PESO: **860** kg • PE: **38** cm

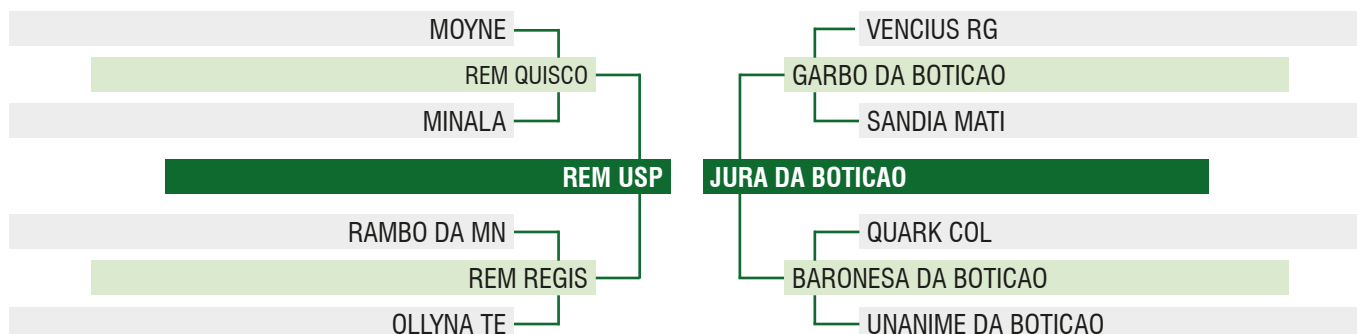

	MGTe	MP120	MP210	DP210	DP365	DP450	DPE365	DPE450	DAOL	DACAB	DIPP	DSTAY	D3P
DEP	21.42	1.87	2.71	13.87	26.69	27.73	0.26	0.69	-1.24	-0.05	-1.49	84.83	88.16
TOP	6%	24%	22%	4%	2%	2%	38%	22%	79%	68%	2%	11%	7%

	iABCZ	PD-ED	PA-ED	PS-ED	PM-EM	TMD	IPP	STAY	PE-365	PE-450	E	P	M	AOL	ACAB
DEP	27.08	15.74	21.83	29.04	1.06	9.80	-31.57	36.11	0.409	1.072	2.903	5.904	5.752	0.276	-1.214
DECA	1	1	1	1	3	1	1	1	2	1	1	1	1	5	9

LOTE
44
INDIVIDUAL

Vendedor: **BOTICÃO NELORE MOCHO**

MECENICO DA BOTICAO

MACHO • NELORE MOCHO PO • BOM 3376 • 17/08/2020
PESO: **760** kg • PE: **36** cm

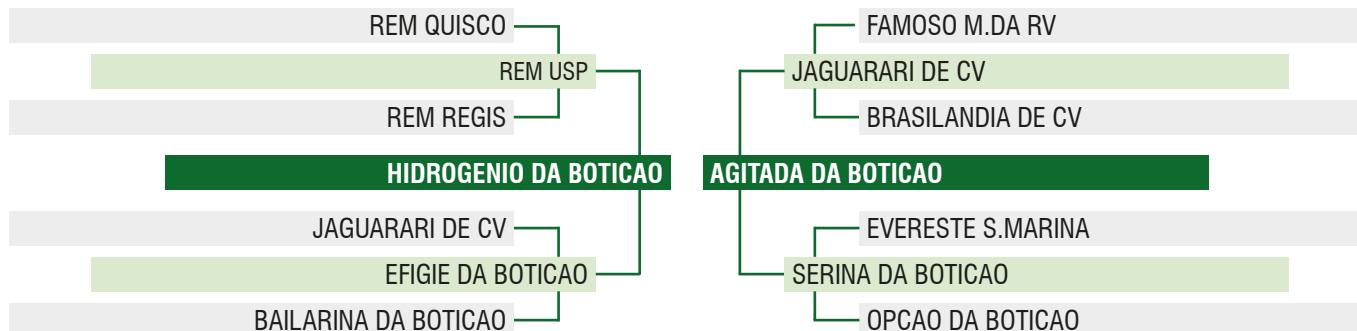

	MGTe	MP120	MP210	DP210	DP365	DP450	DPE365	DPE450	DAOL	DACAB	DIPP	DSTAY	D3P
DEP	16.97	0.15	0.06	11.13	19.20	17.16	0.48	0.59	1.59	0.20	-0.86	76.62	75.44
TOP	14%	69%	74%	8%	9%	14%	25%	25%	10%	28%	21%	22%	51%

	iABCZ	PD-ED	PA-ED	PS-ED	PM-EM	TMD	IPP	STAY	PE-365	PE-450	E	P	M	AOL	ACAB
DEP	11.39	7.17	9.79	16.92	-0.11	2.47	-6.38	33.10	0.234	0.246	2.193	4.630	3.042	1.919	0.529
DECA	1	1	1	1	6	3	4	3	4	4	1	1	1	1	3

LOTE
45
INDIVIDUAL

Vendedor: **BOTICÃO NELORE MOCHO**

MAGO DA BOTICAO

MACHO • NELORE MOCHO PO • BOM 3391 • 19/09/2020
PESO: **765** kg • PE: **33** cm

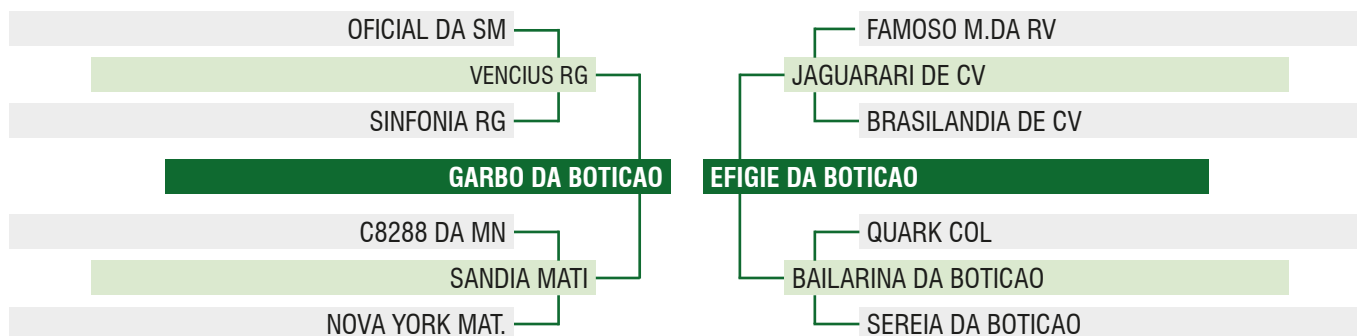

	MGTe	MP120	MP210	DP210	DP365	DP450	DPE365	DPE450	DAOL	DACAB	DIPP	DSTAY	D3P
DEP	17.42	0.78	1.04	11.83	22.05	20.72	0.13	0.17	-0.51	-0.05	-0.98	73.09	87.72
TOP	13%	51%	53%	6%	6%	8%	48%	46%	53%	68%	15%	27%	8%

	iABCZ	PD-ED	PA-ED	PS-ED	PM-EM	TMD	IPP	STAY	PE-365	PE-450	E	P	M	AOL	ACAB
DEP	15.78	11.02	15.57	20.40	0.69	5.60	-17.44	30.68	0.271	-0.009	1.493	3.568	1.789	0.135	-0.476
DECA	1	1	1	1	4	1	1	5	3	6	2	1	2	6	7

LOTE
46
INDIVIDUAL

Vendedor: **BOTICÃO NELORE MOCHO**

METODO DA BOTICAO

MACHO • NELORE MOCHO PO • BOM 3349 • 02/08/2020
PESO: **870** kg • PE: **32** cm

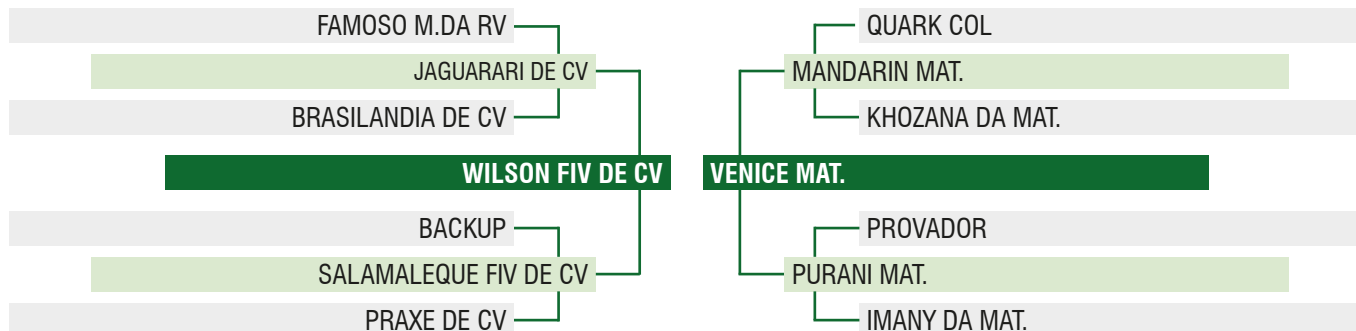

	MGTe	MP120	MP210	DP210	DP365	DP450	DPE365	DPE450	DAOL	DACAB	DIPP	DSTAY	D3P
DEP	26.18	-0.81	-0.88	18.02	32.65	33.09	0.45	0.23	3.75	0.71	-0.59	85.46	80.56
TOP	2%	90%	88%	1%	0.5%	0.5%	27%	43%	2%	5%	40%	10%	32%

	iABCZ	PD-ED	PA-ED	PS-ED	PM-EM	TMD	IPP	STAY	PE-365	PE-450	E	P	M	AOL	ACAB
DEP	22.43	14.62	23.75	31.03	-1.01	6.14	-15.95	34.77	0.274	0.461	2.171	3.638	3.767	4.823	4.097
DECA	1	1	1	1	8	1	1	2	3	3	1	1	1	1	1

LOTE
47
INDIVIDUAL

Vendedor: **BOTICÃO NELORE MOCHO**

MACRO DA BOTICAO

MACHO • NELORE MOCHO PO • BOM 3389 • 19/09/2020
PESO: **845** kg • PE: **38** cm

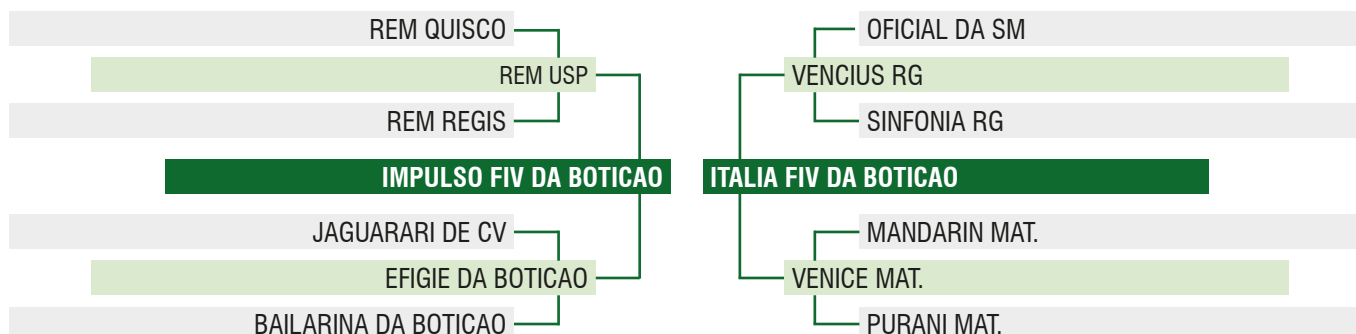

	MGTe	MP120	MP210	DP210	DP365	DP450	DPE365	DPE450	DAOL	DACAB	DIPP	DSTAY	D3P
DEP	20.05	-0.15	-0.49	14.09	19.56	20.09	0.71	1.01	1.17	-0.16	-1.01	85.60	79.25
TOP	8%	78%	84%	3%	9%	9%	16%	13%	14%	83%	13%	10%	37%

	iABCZ	PD-ED	PA-ED	PS-ED	PM-EM	TMD	IPP	STAY	PE-365	PE-450	E	P	M	AOL	ACAB
DEP	9.00	10.66	9.29	12.51	-2.07	1.51	-1.09	32.01	0.169	0.766	2.601	4.267	1.400	2.045	-1.802
DECA	2	1	1	1	10	5	6	4	4	1	1	1	3	1	10

LOTE
48
INDIVIDUAL

Vendedor: **BOTICÃO NELORE MOCHO**

MAESTRO DA BOTICAO

MACHO • NELORE MOCHO PO • BOM 3360 • 08/08/2020
PESO: **840** kg • PE: **34** cm

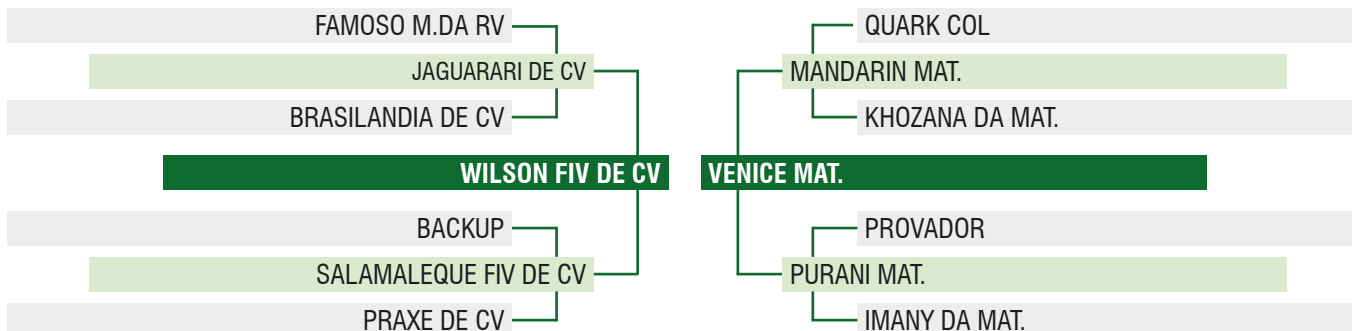

	MGTe	MP120	MP210	DP210	DP365	DP450	DPE365	DPE450	DAOL	DACAB	DIPP	DSTAY	D3P
DEP	18.31	-2.47	-3.26	10.12	18.95	20.67	0.31	0.32	0.59	0.55	-1.05	81.45	88.60
TOP	11%	99%	99%	10%	10%	8%	35%	37%	21%	9%	11%	16%	6%

	iABCZ	PD-ED	PA-ED	PS-ED	PM-EM	TMD	IPP	STAY	PE-365	PE-450	E	P	M	AOL	ACAB
DEP	13.34	8.49	13.29	17.27	-1.78	2.12	-14.68	33.68	0.163	0.246	1.403	4.533	3.422	2.343	2.471
DECA	1	1	1	1	9	4	1	2	4	4	2	1	1	1	1

LOTE
49
INDIVIDUAL

Vendedor: **BOTICÃO NELORE MOCHO**

MAGISTRAL DA BOTICAO

MACHO • NELORE MOCHO PO • BOM 3411 • 27/09/2020
PESO: **780** kg • PE: **36** cm

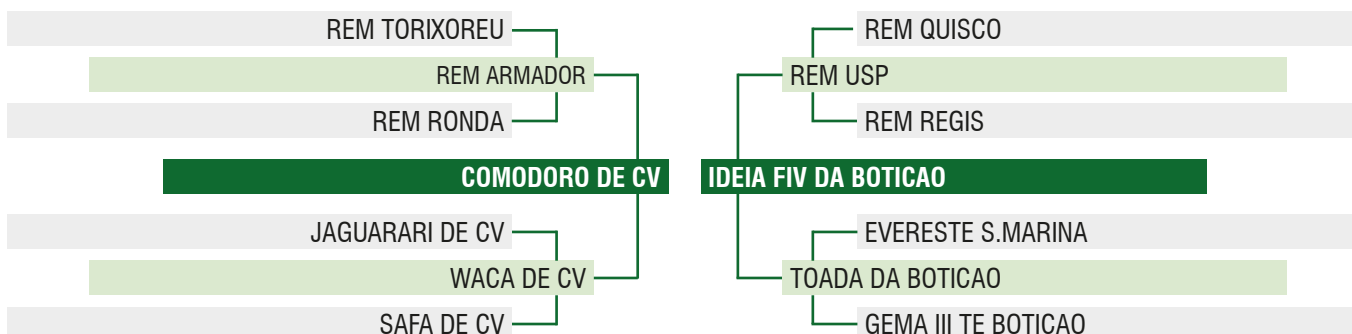

	MGTe	MP120	MP210	DP210	DP365	DP450	DPE365	DPE450	DAOL	DACAB	DIPP	DSTAY	D3P
DEP	18.36	3.47	4.70	8.89	21.32	19.63	0.76	0.81	1.38	0.25	-0.74	74.49	80.46
TOP	11%	5%	5%	14%	6%	10%	15%	18%	12%	24%	29%	25%	32%

	iABCZ	PD-ED	PA-ED	PS-ED	PM-EM	TMD	IPP	STAY	PE-365	PE-450	E	P	M	AOL	ACAB
DEP	19.05	9.18	13.96	21.09	3.27	8.55	-21.36	32.38	0.765	1.024	1.427	4.117	3.354	2.508	0.795
DECA	1	1	1	1	1	1	1	3	1	1	2	1	1	1	2

LOTE
50
 INDIVIDUAL

 Vendedor: **BOTICÃO NELORE MOCHO**

MANCEBO DA BOTICAO

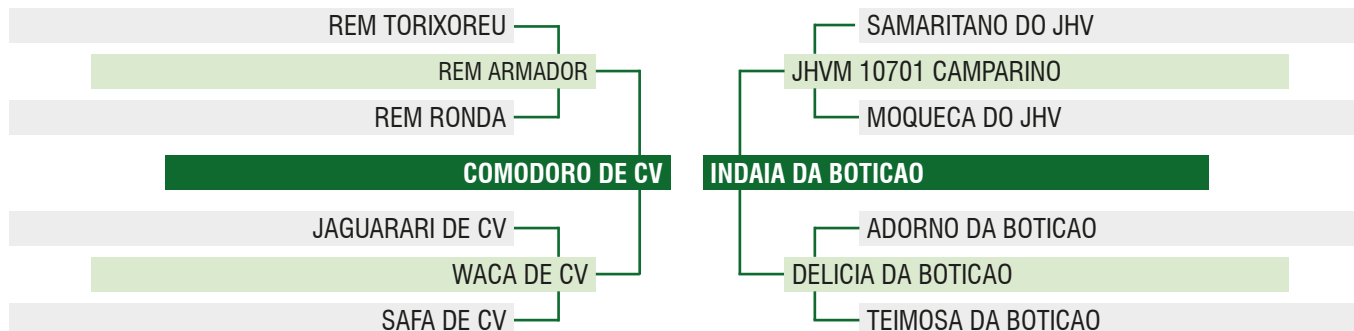
 MACHO • NELORE MOCHO PO • BOM 3406 • 24/09/2020
 PESO: **755** kg • PE: **37** cm

	MGTe	MP120	MP210	DP210	DP365	DP450	DPE365	DPE450	DAOL	DACAB	DIPP	DSTAY	D3P
DEP	22.97	6.19	8.28	13.83	25.16	24.09	1.76	2.01	3.79	0.54	-0.33	78.38	63.36
TOP	4%	0.5%	0.5%	4%	3%	5%	1%	2%	1%	9%	61%	20%	82%

	iABCZ	PD-ED	PA-ED	PS-ED	PM-EM	TMD	IPP	STAY	PE-365	PE-450	E	P	M	AOL	ACAB
DEP	22.89	13.35	14.73	18.85	2.93	10.12	-32.39	33.51	0.896	1.186	0.397	4.016	3.590	3.341	2.538
DECA	1	1	1	1	1	1	1	2	1	1	5	1	1	1	1

 LOTE
51
 INDIVIDUAL

 Vendedor: **BOTICÃO NELORE MOCHO**

MAPUCHE DA BOTICAO

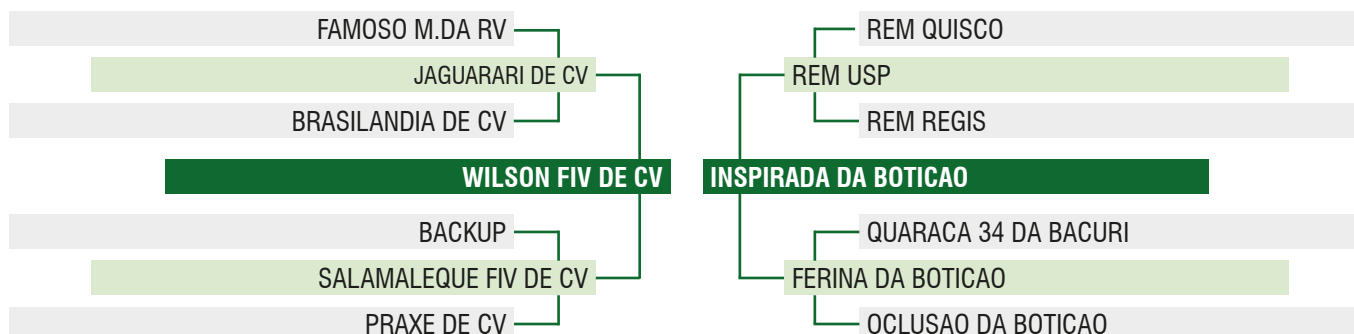
 MACHO • NELORE MOCHO PO • BOM 3413 • 28/09/2020
 PESO: **760** kg • PE: **37** cm

	MGTe	MP120	MP210	DP210	DP365	DP450	DPE365	DPE450	DAOL	DACAB	DIPP	DSTAY	D3P
DEP	17.16	-1.30	-1.73	10.05	23.13	19.85	0.34	0.30	0.74	0.56	-0.75	79.90	79.33
TOP	14%	94%	94%	10%	5%	9%	33%	38%	19%	9%	28%	18%	37%

	iABCZ	PD-ED	PA-ED	PS-ED	PM-EM	TMD	IPP	STAY	PE-365	PE-450	E	P	M	AOL	ACAB
DEP	15.30	9.25	13.66	18.45	-0.99	3.30	-17.85	33.81	0.341	0.565	0.881	4.632	3.669	1.941	1.849
DECA	1	1	1	1	8	3	1	2	3	2	3	1	1	1	1

LOTE
52
 BATERIA 01

 Vendedor: **BOTICÃO NELORE MOCHO**

MUNDO DA BOTICAO

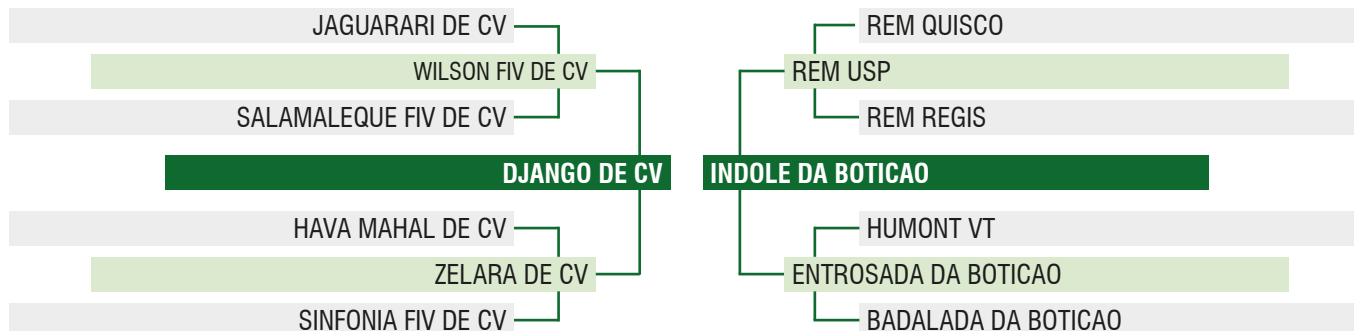
 MACHO • NELORE MOCHO PO • BOM 3477 • 19/11/2020
 PESO: **675** kg • PE: **36** cm

	iABCZ	PD-ED	PA-ED	PS-ED	PM-EM	TMD	IPP	STAY	PE-365	PE-450	E	P	M	AOL	ACAB
DEP	19.27	6.20	10.74	14.67	3.12	7.29	-29.98	36.11	0.730	1.230	0.210	3.530	2.900	1.490	1.620
DECA	1	1	1	1	1	1	1	1	1	1	6	1	1	2	1

 LOTE
53
 BATERIA 01

 Vendedor: **BOTICÃO NELORE MOCHO**

MOTIVO DA BOTICAO

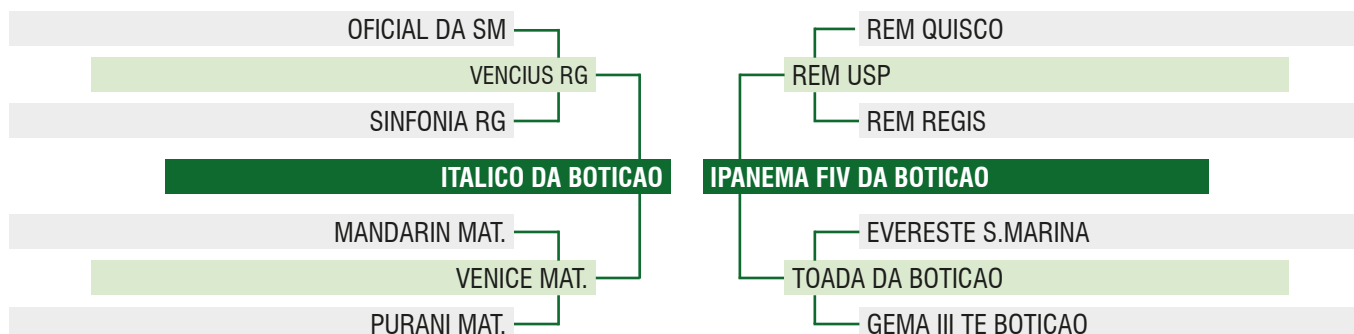
 MACHO • NELORE MOCHO PO • BOM 3447 • 20/10/2020
 PESO: **660** kg • PE: **34** cm

	MGTe	MP120	MP210	DP210	DP365	DP450	DPE365	DPE450	DAOL	DACAB	DIPP	DSTAY	D3P
DEP	16.58	2.16	2.81	9.36	14.62	19.21	0.60	1.02	-1.29	0.18	-0.89	77.40	81.83
TOP	15%	19%	20%	12%	19%	10%	20%	13%	80%	30%	19%	21%	27%

	iABCZ	PD-ED	PA-ED	PS-ED	PM-EM	TMD	IPP	STAY	PE-365	PE-450	E	P	M	AOL	ACAB
DEP	13.72	5.79	10.57	15.94	2.49	5.84	-9.00	33.31	0.598	0.742	2.834	2.782	3.155	-0.146	-0.230
DECA	1	1	1	1	1	1	3	2	1	2	1	1	1	7	6

LOTE
54
 BATERIA 01

 Vendedor: **BOTICÃO NELORE MOCHO**

MAGNATA DA BOTICAO

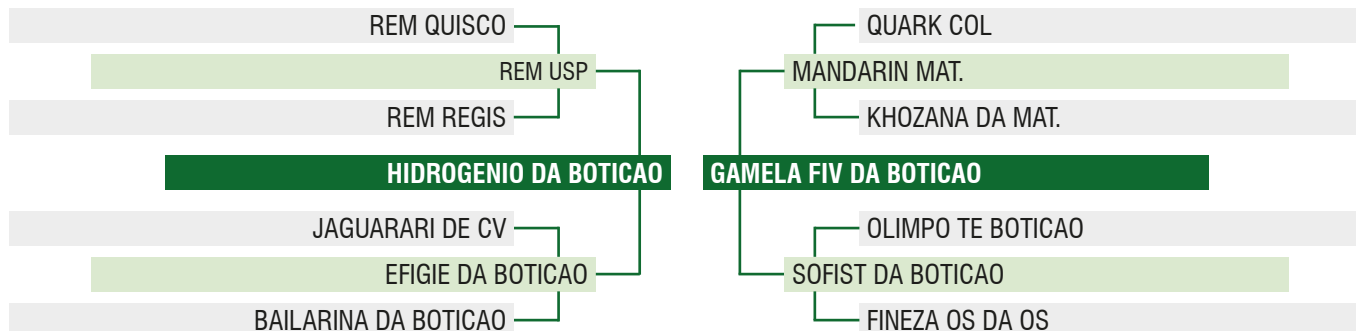
 MACHO • NELORE MOCHO PO • BOM 3372 • 13/08/2020
 PESO: **720** kg • PE: **35** cm

	MGTe	MP120	MP210	DP210	DP365	DP450	DPE365	DPE450	DAOL	DACAB	DIPP	DSTAY	D3P
DEP	22.19	-0.57	-0.85	17.22	27.02	26.33	0.22	0.41	2.70	0.34	-0.79	83.77	73.09
TOP	5%	87%	88%	1%	2%	3%	41%	33%	4%	18%	25%	12%	59%

	iABCZ	PD-ED	PA-ED	PS-ED	PM-EM	TMD	IPP	STAY	PE-365	PE-450	E	P	M	AOL	ACAB
DEP	18.09	13.89	19.41	23.46	-0.19	6.72	1.62	35.56	0.286	0.406	2.142	1.709	1.018	2.119	-0.035
DECA	1	1	1	1	6	1	7	1	3	3	1	2	3	1	5

 LOTE
55
 BATERIA 02

 Vendedor: **BOTICÃO NELORE MOCHO**

MAIOR DA BOTICAO

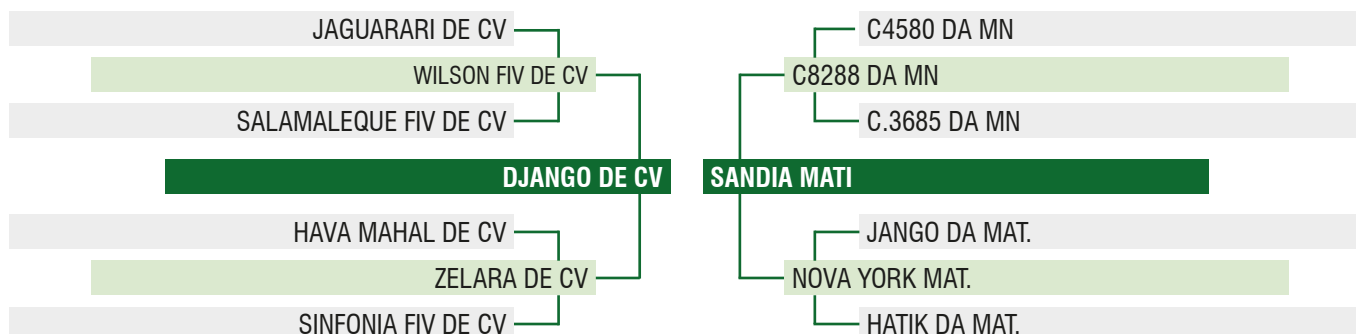
 MACHO • NELORE MOCHO PO • BOM 3396 • 22/09/2020
 PESO: **710** kg • PE: **34** cm

	MGTe	MP120	MP210	DP210	DP365	DP450	DPE365	DPE450	DAOL	DACAB	DIPP	DSTAY	D3P
DEP	18.68	1.19	1.49	7.95	17.23	18.44	0.23	-0.02	1.58	0.26	-0.84	84.84	83.28
TOP	11%	40%	44%	18%	13%	12%	40%	62%	10%	23%	22%	11%	22%

	iABCZ	PD-ED	PA-ED	PS-ED	PM-EM	TMD	IPP	STAY	PE-365	PE-450	E	P	M	AOL	ACAB
DEP	23.30	7.60	12.90	20.57	2.17	6.46	-37.09	39.18	0.428	0.834	0.239	4.943	3.795	2.787	3.240
DECA	1	1	1	1	1	1	1	1	2	1	6	1	1	1	1

LOTE
56
BATERIA 02

Vendedor: **BOTICÃO NELORE MOCHO**

MAXIMO DA BOTICAO

MACHO • NELORE MOCHO PO • BOM 3362 • 09/08/2020
PESO: **690** kg • PE: **36** cm

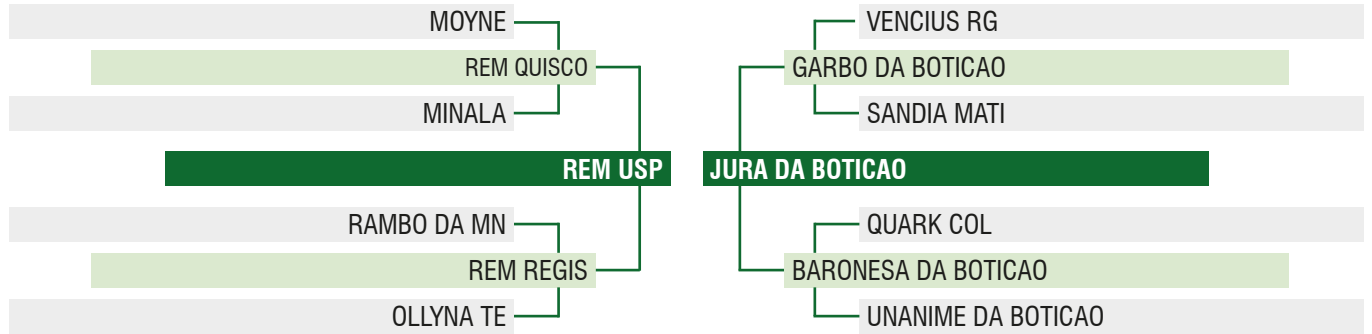

	MGTe	MP120	MP210	DP210	DP365	DP450	DPE365	DPE450	DAOL	DACAB	DIPP	DSTAY	D3P
DEP	16.58	0.40	0.67	8.25	13.52	12.62	0.52	0.55	0.72	-0.21	-1.16	81.34	86.73
TOP	15%	62%	61%	17%	22%	27%	24%	27%	19%	87%	7%	16%	11%

	iABCZ	PD-ED	PA-ED	PS-ED	PM-EM	TMD	IPP	STAY	PE-365	PE-450	E	P	M	AOL	ACAB
DEP	15.00	8.37	9.57	14.47	-1.22	2.68	-18.72	36.52	0.364	0.591	1.511	3.325	3.921	2.100	-1.820
DECA	1	1	1	1	9	3	1	1	3	2	2	1	1	1	10

LOTE
57
BATERIA 02

Vendedor: **BOTICÃO NELORE MOCHO**

MESTRE DA BOTICAO

MACHO • NELORE MOCHO PO • BOM 3353 • 05/08/2020
PESO: **650** kg • PE: **31** cm

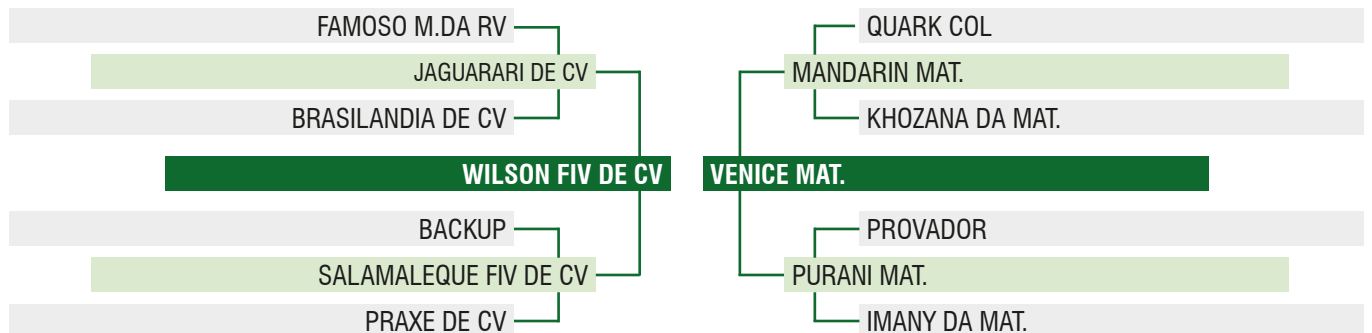

	MGTe	MP120	MP210	DP210	DP365	DP450	DPE365	DPE450	DAOL	DACAB	DIPP	DSTAY	D3P
DEP	18.14	-2.47	-3.26	10.12	18.95	19.72	0.31	0.32	0.59	0.55	-1.05	81.45	88.60
TOP	12%	99%	99%	10%	10%	10%	35%	37%	21%	9%	11%	16%	6%

	iABCZ	PD-ED	PA-ED	PS-ED	PM-EM	TMD	IPP	STAY	PE-365	PE-450	E	P	M	AOL	ACAB
DEP	13.32	8.57	13.18	17.12	-1.78	2.16	-14.65	33.68	0.160	0.242	1.403	4.533	3.422	2.343	2.471
DECA	1	1	1	1	9	4	1	2	4	4	2	1	1	1	1

LOTE
58
BATERIA 03

Vendedor: **BOTICÃO NELORE MOCHO**

MASTRO DA BOTICAO

MACHO • NELORE MOCHO PO • BOM 3492 • 01/12/2020
PESO: **620** kg • PE: **33** cm

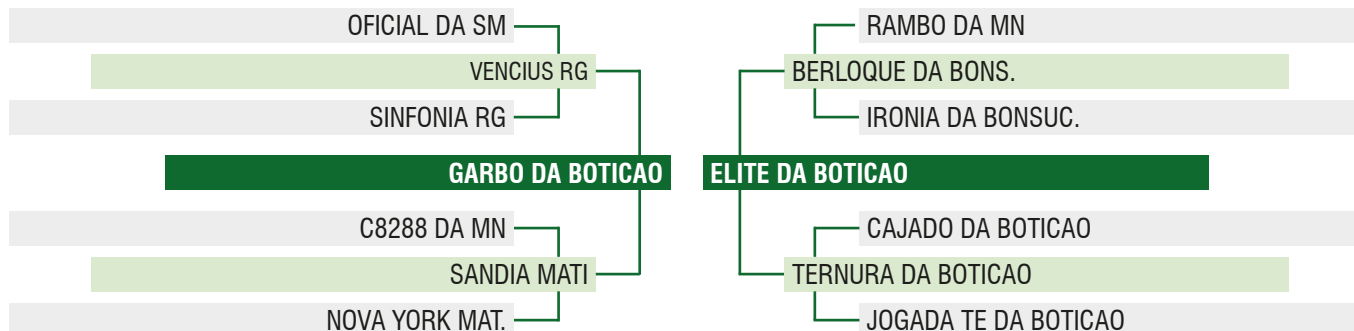

	iABCZ	PD-ED	PA-ED	PS-ED	PM-EM	TMD	IPP	STAY	PE-365	PE-450	E	P	M	AOL	ACAB
DEP	8.40	4.67	8.20	9.21	-0.96	0.59	-8.26	33.43	0.260	0.110	0.220	2.230	2.950	-0.660	0.720
DECA	2	2	2	2	8	6	3	2	3	5	6	2	1	8	3

LOTE
59
BATERIA 03

Vendedor: **BOTICÃO NELORE MOCHO**

MINERAL DA BOTICAO

MACHO • NELORE MOCHO PO • BOM 3367 • 11/08/2020
PESO: **710** kg • PE: **33** cm

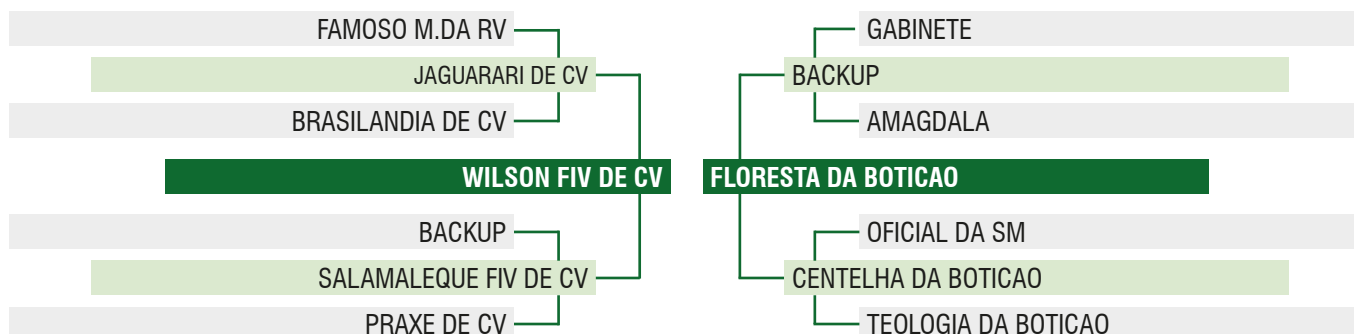

	MGTe	MP120	MP210	DP210	DP365	DP450	DPE365	DPE450	DAOL	DACAB	DIPP	DSTAY	D3P
DEP	15.59	-1.95	-2.70	9.61	16.93	16.69	0.26	0.05	1.59	0.52	-0.77	72.75	79.83
TOP	17%	98%	98%	12%	13%	15%	38%	55%	10%	10%	27%	28%	35%

	iABCZ	PD-ED	PA-ED	PS-ED	PM-EM	TMD	IPP	STAY	PE-365	PE-450	E	P	M	AOL	ACAB
DEP	10.68	5.95	11.04	15.26	-1.87	0.42	-15.63	32.42	0.213	-0.098	1.010	3.113	2.246	2.590	2.286
DECA	2	1	1	1	10	6	1	3	4	7	3	1	1	1	1

LOTE
60
BATERIA 03

Vendedor: **BOTICÃO NELORE MOCHO**

MISSIL DA BOTICAO

MACHO • NELORE MOCHO PO • BOM 3436 • 13/10/2020
PESO: **600** kg • PE: **39** cm

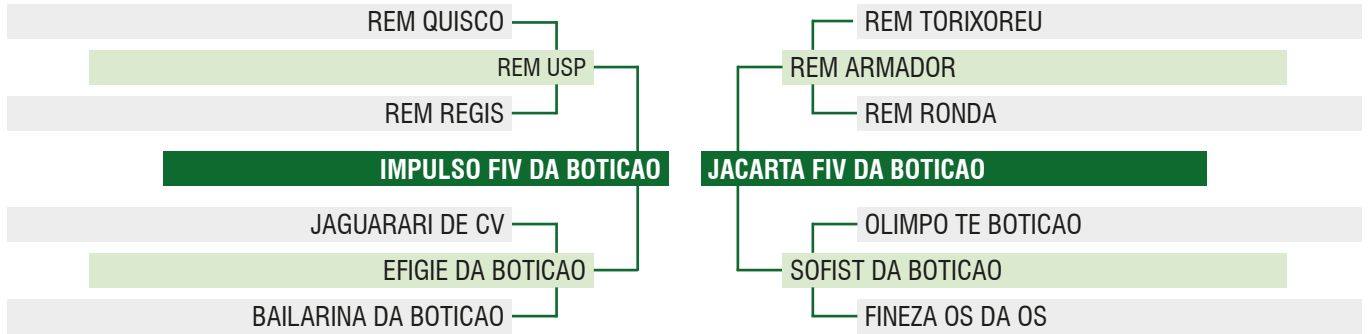

	MGTe	MP120	MP210	DP210	DP365	DP450	DPE365	DPE450	DAOL	DACAB	DIPP	DSTAY	D3P
DEP	20.80	1.88	2.38	10.26	14.02	18.60	0.62	0.85	2.62	0.11	-1.03	85.78	82.56
TOP	7%	24%	27%	10%	20%	11%	20%	17%	4%	38%	12%	9%	24%

	iABCZ	PD-ED	PA-ED	PS-ED	PM-EM	TMD	IPP	STAY	PE-365	PE-450	E	P	M	AOL	ACAB
DEP	15.75	5.72	9.98	14.92	1.64	4.55	-15.74	36.96	0.451	0.893	0.593	3.744	2.691	3.533	0.830
DECA	1	2	1	1	2	2	1	1	2	1	4	1	1	1	2

LOTE
61
BATERIA 04

Vendedor: **BOTICÃO NELORE MOCHO**

MULTIPLO DA BOTICAO

MACHO • NELORE MOCHO PO • BOM 3467 • 14/11/2020
PESO: **650** kg • PE: **38** cm

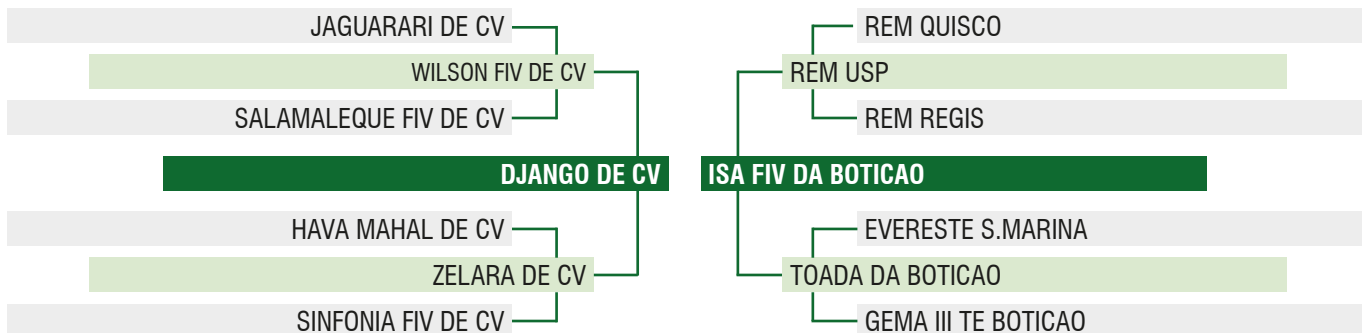

	MGTe	MP120	MP210	DP210	DP365	DP450	DPE365	DPE450	DAOL	DACAB	DIPP	DSTAY	D3P
DEP	20.29	1.68	2.30	6.67	17.09	19.41	0.85	1.01	1.82	0.65	-1.12	86.64	86.71
TOP	8%	28%	28%	25%	13%	10%	12%	13%	8%	6%	9%	8%	11%

	iABCZ	PD-ED	PA-ED	PS-ED	PM-EM	TMD	IPP	STAY	PE-365	PE-450	E	P	M	AOL	ACAB
DEP	16.34	4.78	9.81	15.30	1.89	4.40	-25.46	35.42	0.623	1.151	0.126	4.181	2.558	2.032	1.719
DECA	1	2	1	1	2	2	1	1	1	1	6	1	1	1	1

LOTE
62
 BATERIA 04

 Vendedor: **BOTICÃO NELORE MOCHO**

MOSAICO DA BOTICAO

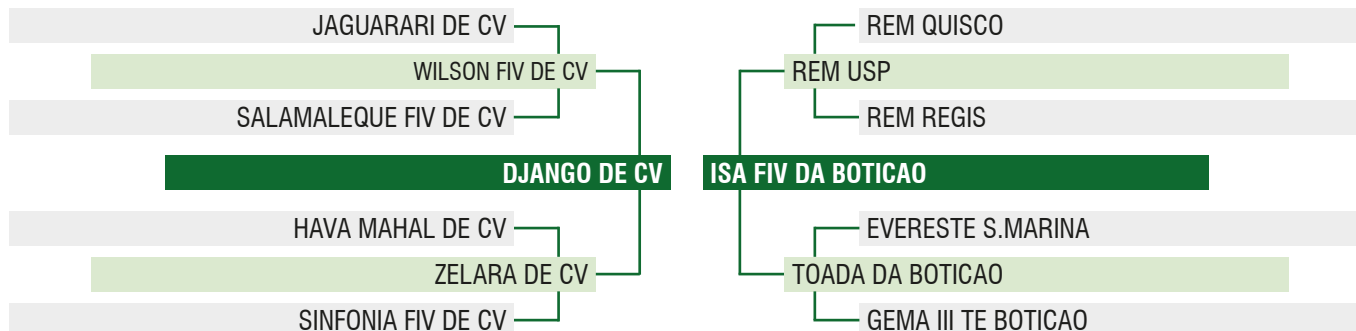
 MACHO • NELORE MOCHO PO • BOM 3464 • 13/11/2020
 PESO: **620** kg • PE: **37** cm

	MGTe	MP120	MP210	DP210	DP365	DP450	DPE365	DPE450	DAOL	DACAB	DIPP	DSTAY	D3P
DEP	19.96	1.68	2.30	6.67	17.09	17.57	0.85	0.92	1.82	0.65	-1.12	86.64	86.71
TOP	8%	28%	28%	25%	13%	13%	12%	15%	8%	6%	9%	8%	11%

	iABCZ	PD-ED	PA-ED	PS-ED	PM-EM	TMD	IPP	STAY	PE-365	PE-450	E	P	M	AOL	ACAB
DEP	14.33	2.61	7.73	13.09	1.89	3.32	-24.81	35.42	0.560	1.051	0.126	4.181	2.558	2.032	1.719
DECA	1	4	2	1	2	3	1	1	1	1	6	1	1	1	1

 LOTE
63
 BATERIA 04

 Vendedor: **BOTICÃO NELORE MOCHO**

MALAIQ DA BOTICAO

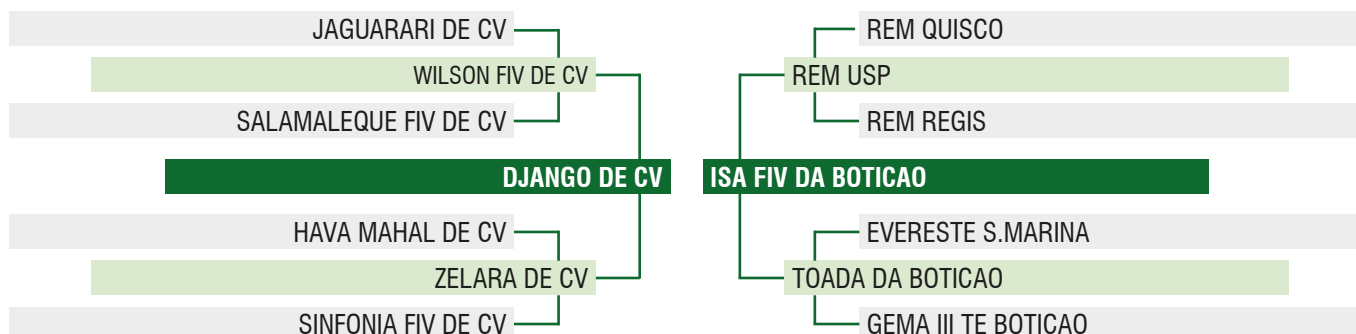
 MACHO • NELORE MOCHO PO • BOM 3394 • 20/09/2020
 PESO: **660** kg • PE: **34** cm

	MGTe	MP120	MP210	DP210	DP365	DP450	DPE365	DPE450	DAOL	DACAB	DIPP	DSTAY	D3P
DEP	19.96	1.68	2.30	6.67	17.09	17.57	0.85	0.92	1.82	0.65	-1.12	86.64	86.71
TOP	8%	28%	28%	25%	13%	13%	12%	15%	8%	6%	9%	8%	11%

	iABCZ	PD-ED	PA-ED	PS-ED	PM-EM	TMD	IPP	STAY	PE-365	PE-450	E	P	M	AOL	ACAB
DEP	14.87	3.06	8.43	13.82	1.89	3.54	-25.03	35.42	0.581	1.083	0.126	4.181	2.558	2.032	1.719
DECA	1	3	1	1	2	2	1	1	1	1	6	1	1	1	1

LOTE
65
 INDIVIDUAL

 Vendedor: **BOTICÃO NELORE MOCHO**

MENINO DA BOTICAO

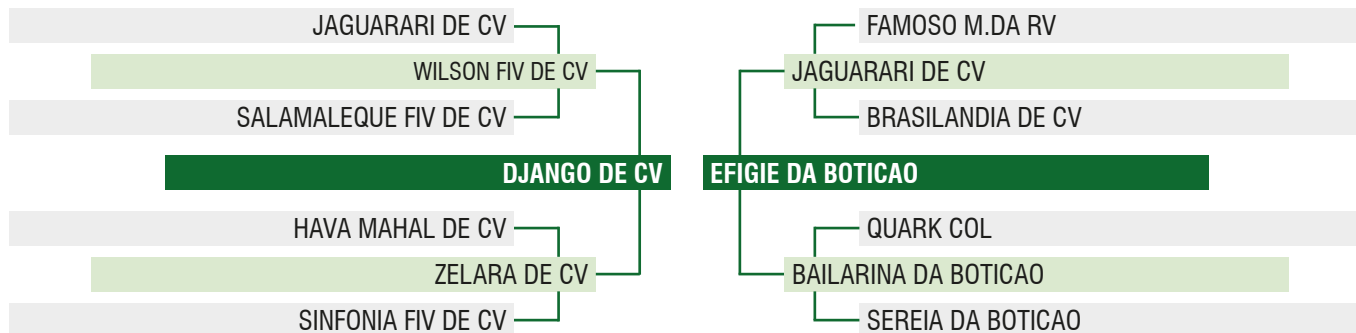
 MACHO • NELORE MOCHO PO • BOM 3482 • 23/11/2020
 PESO: **670** kg • PE: **33** cm

	MGTe	MP120	MP210	DP210	DP365	DP450	DPE365	DPE450	DAOL	DACAB	DIPP	DSTAY	D3P
DEP	18.73	1.65	2.17	6.44	17.39	17.66	0.76	0.42	2.74	0.46	-1.04	78.00	85.47
TOP	10%	29%	30%	26%	12%	13%	15%	32%	4%	12%	12%	21%	14%

	iABCZ	PD-ED	PA-ED	PS-ED	PM-EM	TMD	IPP	STAY	PE-365	PE-450	E	P	M	AOL	ACAB
DEP	14.52	5.67	8.88	17.01	1.92	4.77	-21.99	32.74	0.441	0.602	1.710	5.035	2.882	3.771	2.157
DECA	1	2	1	1	2	1	1	3	2	2	1	1	1	1	1

 LOTE
66
 INDIVIDUAL

 Vendedor: **BOTICÃO NELORE MOCHO**

MAIORAL DA BOTICAO

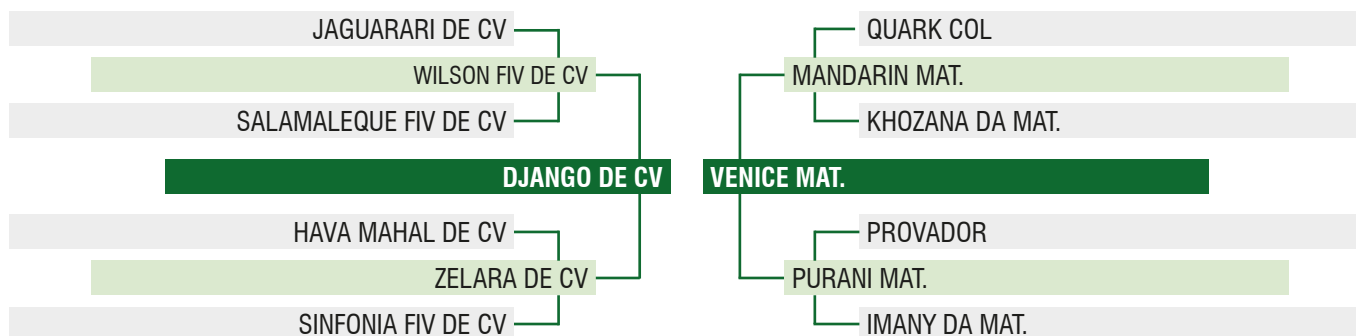
 MACHO • NELORE MOCHO PO • BOM 3395 • 21/09/2020
 PESO: **665** kg • PE: **33** cm

	MGTe	MP120	MP210	DP210	DP365	DP450	DPE365	DPE450	DAOL	DACAB	DIPP	DSTAY	D3P
DEP	18.33	0.76	1.09	6.50	14.54	14.93	0.56	0.53	1.07	0.45	-1.19	85.15	89.60
TOP	11%	52%	52%	26%	19%	20%	22%	28%	15%	13%	6%	10%	4%

	iABCZ	PD-ED	PA-ED	PS-ED	PM-EM	TMD	IPP	STAY	PE-365	PE-450	E	P	M	AOL	ACAB
DEP	15.52	5.42	8.99	12.50	2.01	5.41	-22.47	35.78	0.357	0.814	0.765	4.421	3.148	2.338	2.150
DECA	1	2	1	1	2	1	1	1	3	1	4	1	1	1	1

LOTE
67
 BATERIA 05

 Vendedor: **BOTICÃO NELORE MOCHO**

MOZART DA BOTICAO

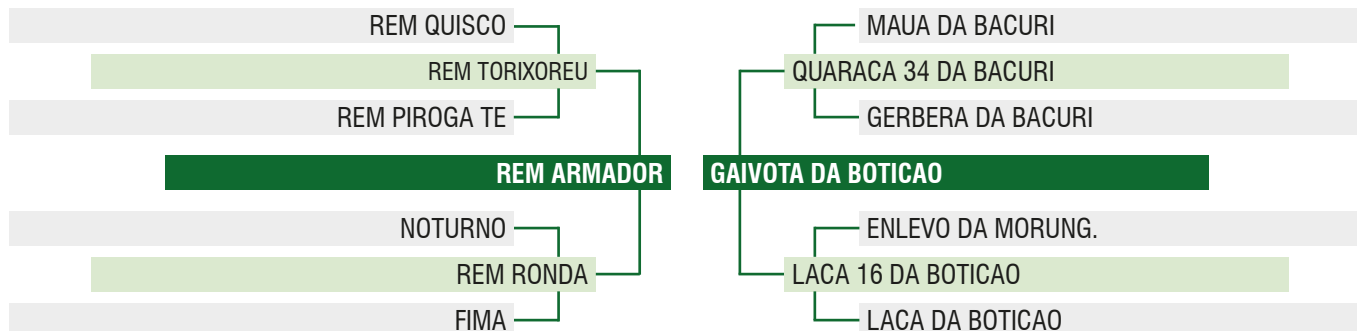
 MACHO • NELORE MOCHO PO • BOM 3487 • 25/11/2020
 PESO: **650** kg • PE: **33** cm

	MGTe	MP120	MP210	DP210	DP365	DP450	DPE365	DPE450	DAOL	DACAB	DIPP	DSTAY	D3P
DEP	18.92	2.57	3.52	9.50	19.35	16.73	1.22	1.38	1.80	0.08	-0.96	79.66	79.85
TOP	10%	13%	12%	12%	9%	15%	5%	6%	8%	43%	16%	18%	35%

	iABCZ	PD-ED	PA-ED	PS-ED	PM-EM	TMD	IPP	STAY	PE-365	PE-450	E	P	M	AOL	ACAB
DEP	20.55	8.67	12.49	16.05	2.92	8.28	-19.39	37.58	1.009	1.936	1.149	3.462	2.787	2.997	1.263
DECA	1	1	1	1	1	1	1	1	1	1	2	1	1	1	1

 LOTE
68
 BATERIA 05

 Vendedor: **BOTICÃO NELORE MOCHO**

MAGNO DA BOTICAO

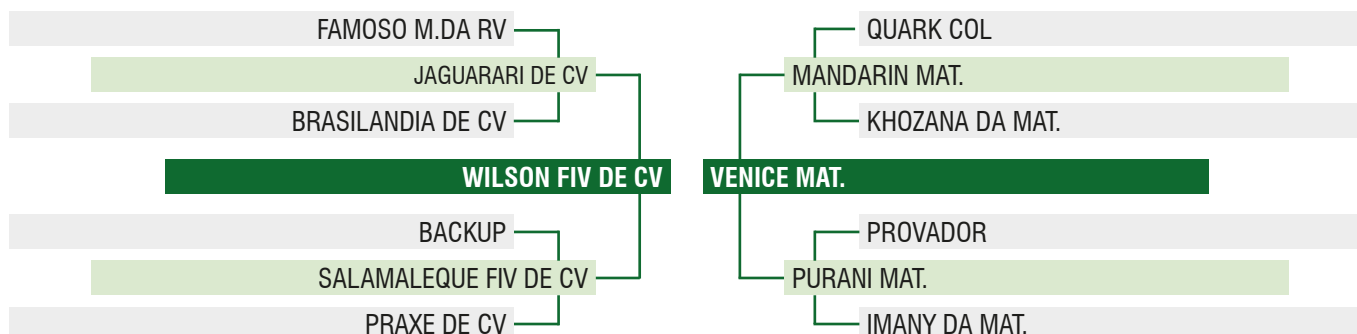
 MACHO • NELORE MOCHO PO • BOM 3357 • 06/08/2020
 PESO: **680** kg • PE: **32** cm

	MGTe	MP120	MP210	DP210	DP365	DP450	DPE365	DPE450	DAOL	DACAB	DIPP	DSTAY	D3P
DEP	14.90	-4.15	-5.22	7.72	15.35	16.08	0.01	0.27	-0.32	0.90	-1.13	77.54	89.80
TOP	19%	100%	100%	19%	17%	17%	60%	40%	47%	2%	8%	21%	4%

	iABCZ	PD-ED	PA-ED	PS-ED	PM-EM	TMD	IPP	STAY	PE-365	PE-450	E	P	M	AOL	ACAB
DEP	7.19	4.87	8.48	12.09	-3.84	-2.33	-13.28	32.33	0.083	0.059	-0.196	4.038	3.961	1.212	4.811
DECA	3	2	1	1	10	9	2	3	5	6	7	1	1	2	1

LOTE
69
 BATERIA 05

 Vendedor: **BOTICÃO NELORE MOCHO**

MATRIZ DA BOTICAO

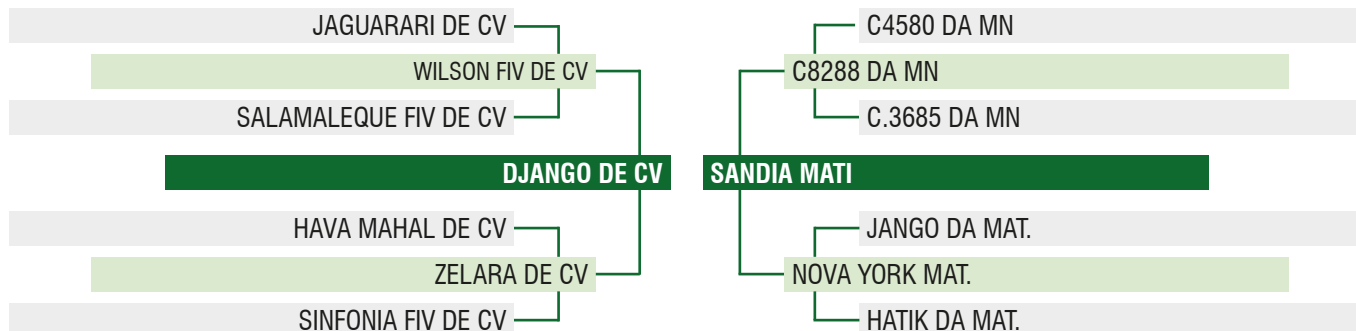
 MACHO • NELORE MOCHO PO • BOM 3405 • 24/09/2020
 PESO: **700** kg • PE: **35** cm

	MGTe	MP120	MP210	DP210	DP365	DP450	DPE365	DPE450	DAOL	DACAB	DIPP	DSTAY	D3P
DEP	18.68	1.19	1.49	7.95	17.23	18.44	0.23	-0.02	1.58	0.26	-0.84	84.84	83.28
TOP	11%	40%	44%	18%	13%	12%	40%	62%	10%	23%	22%	11%	22%

	iABCZ	PD-ED	PA-ED	PS-ED	PM-EM	TMD	IPP	STAY	PE-365	PE-450	E	P	M	AOL	ACAB
DEP	23.39	7.39	13.34	20.93	2.17	6.36	-37.23	39.18	0.442	0.856	0.239	4.943	3.795	2.787	3.240
DECA	1	1	1	1	1	1	1	1	2	1	6	1	1	1	1

 LOTE
70
 BATERIA 06

 Vendedor: **BOTICÃO NELORE MOCHO**

MARFIM DA BOTICAO

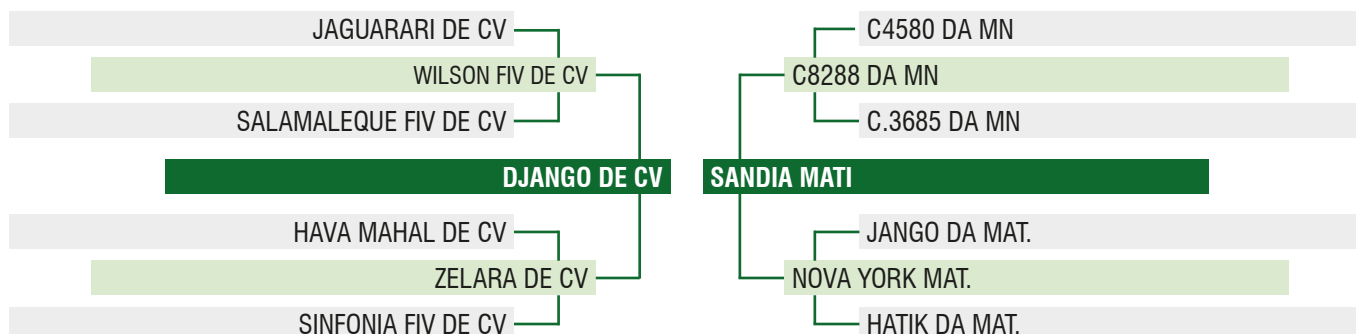
 MACHO • NELORE MOCHO PO • BOM 3383 • 16/09/2020
 PESO: **655** kg • PE: **35** cm

	MGTe	MP120	MP210	DP210	DP365	DP450	DPE365	DPE450	DAOL	DACAB	DIPP	DSTAY	D3P
DEP	18.68	1.19	1.49	7.95	17.23	18.44	0.23	-0.02	1.58	0.26	-0.84	84.84	83.28
TOP	11%	40%	44%	18%	13%	12%	40%	62%	10%	23%	22%	11%	22%

	iABCZ	PD-ED	PA-ED	PS-ED	PM-EM	TMD	IPP	STAY	PE-365	PE-450	E	P	M	AOL	ACAB
DEP	23.30	7.60	12.90	20.57	2.17	6.46	-37.09	39.18	0.428	0.834	0.239	4.943	3.795	2.787	3.240
DECA	1	1	1	1	1	1	1	1	2	1	6	1	1	1	1

LOTE
71
BATERIA 06

Vendedor: **BOTICÃO NELORE MOCHO**

LAURREL DA BOTICAO

MACHO • NELORE MOCHO PO • BOM 3347 • 28/03/2020
PESO: **650** kg • PE: **40** cm

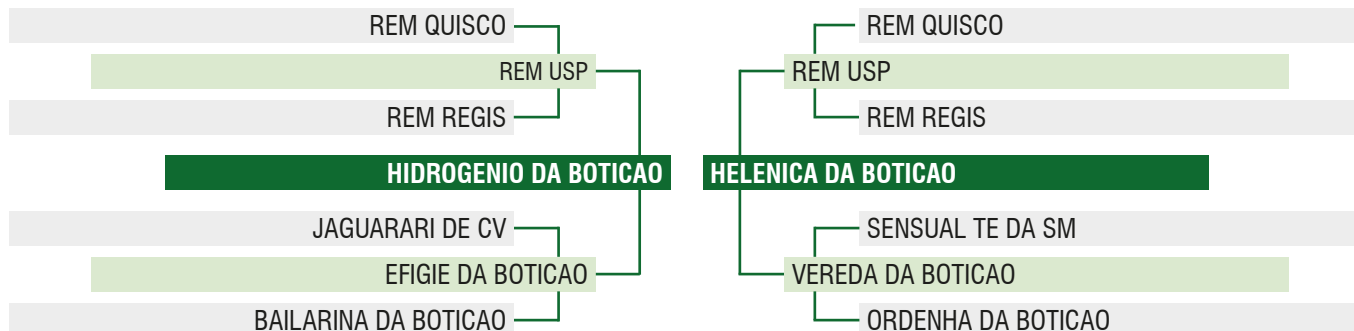

	MGTe	MP120	MP210	DP210	DP365	DP450	DPE365	DPE450	DAOL	DACAB	DIPP	DSTAY	D3P
DEP													
TOP	%	%	%	%	%	%	%	%	%	%	%	%	%

	iABCZ	PD-ED	PA-ED	PS-ED	PM-EM	TMD	IPP	STAY	PE-365	PE-450	E	P	M	AOL	ACAB
DEP	17.76	9.51	12.63	18.79	1.29	6.00	-13.74	35.89	0.580	0.706	0.975	3.094	1.921	1.451	-0.709
DECA	1	1	1	1	3	1	2	1	1	1	3	1	2	2	8

LOTE
72
BATERIA 06

Vendedor: **BOTICÃO NELORE MOCHO**

MOTOR DA BOTICAO

MACHO • NELORE MOCHO PO • BOM 3456 • 08/11/2020
PESO: **640** kg • PE: **36** cm

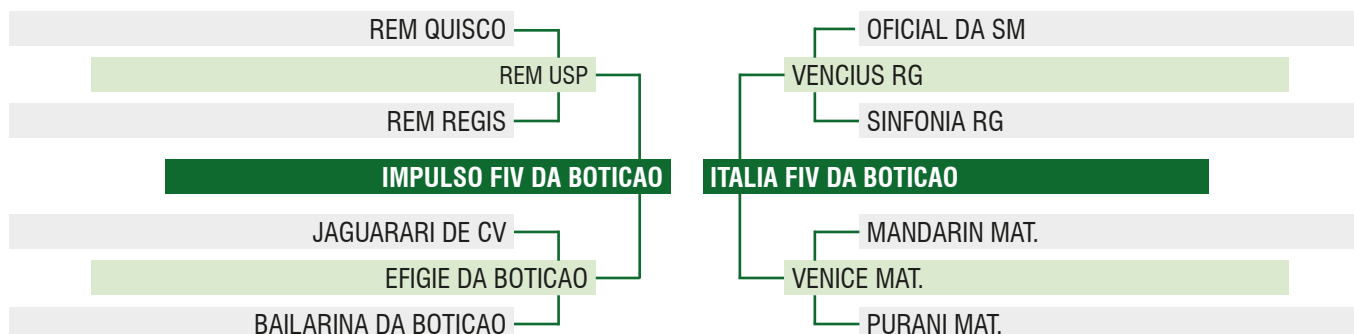

	MGTe	MP120	MP210	DP210	DP365	DP450	DPE365	DPE450	DAOL	DACAB	DIPP	DSTAY	D3P
DEP	21.72	2.21	2.75	11.82	15.99	19.27	0.69	1.17	0.86	0.16	-1.18	89.91	86.27
TOP	6%	18%	21%	6%	15%	10%	17%	10%	17%	32%	7%	4%	12%

	iABCZ	PD-ED	PA-ED	PS-ED	PM-EM	TMD	IPP	STAY	PE-365	PE-450	E	P	M	AOL	ACAB
DEP	14.56	6.51	9.76	17.30	2.61	5.04	-3.83	35.51	0.665	0.552	1.281	3.388	2.138	0.710	0.564
DECA	1	1	1	1	1	1	5	1	1	2	2	1	1	4	3

LOTE
73
 BATERIA 07

 Vendedor: **BOTICÃO NELORE MOCHO**

MIDAS DA BOTICAO

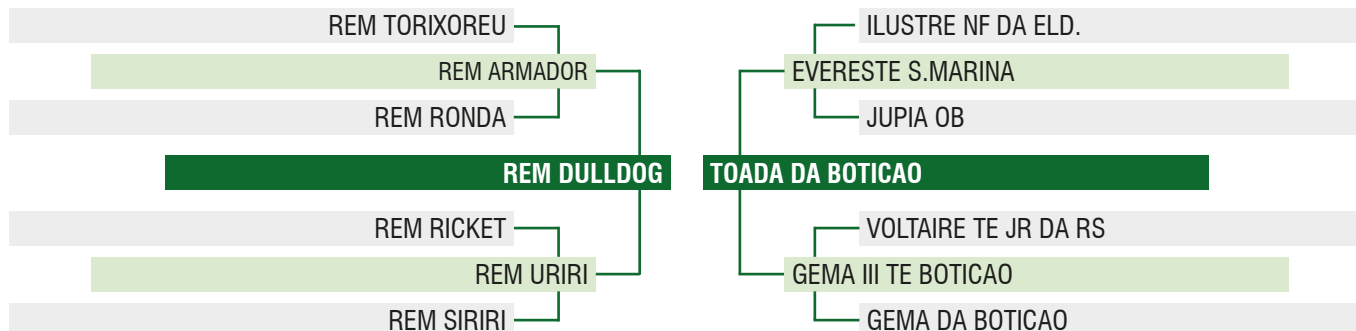
 MACHO • NELORE MOCHO PO • BOM 3485 • 23/11/2020
 PESO: **680** kg • PE: **35** cm

	MGTe	MP120	MP210	DP210	DP365	DP450	DPE365	DPE450	DAOL	DACAB	DIPP	DSTAY	D3P
DEP	17.64	2.66	3.84	9.92	19.51	22.55	1.10	1.37	1.67	0.24	-0.65	68.77	74.50
TOP	13%	12%	10%	11%	9%	6%	7%	6%	9%	25%	35%	34%	54%

	iABCZ	PD-ED	PA-ED	PS-ED	PM-EM	TMD	IPP	STAY	PE-365	PE-450	E	P	M	AOL	ACAB
DEP	18.29	9.26	14.67	20.15	2.95	8.72	-6.91	34.37	1.000	1.422	3.225	2.279	1.608	2.257	1.101
DECA	1	1	1	1	1	1	3	2	1	1	1	2	2	1	2

 LOTE
74
 BATERIA 07

 Vendedor: **BOTICÃO NELORE MOCHO**

METAL DA BOTICAO

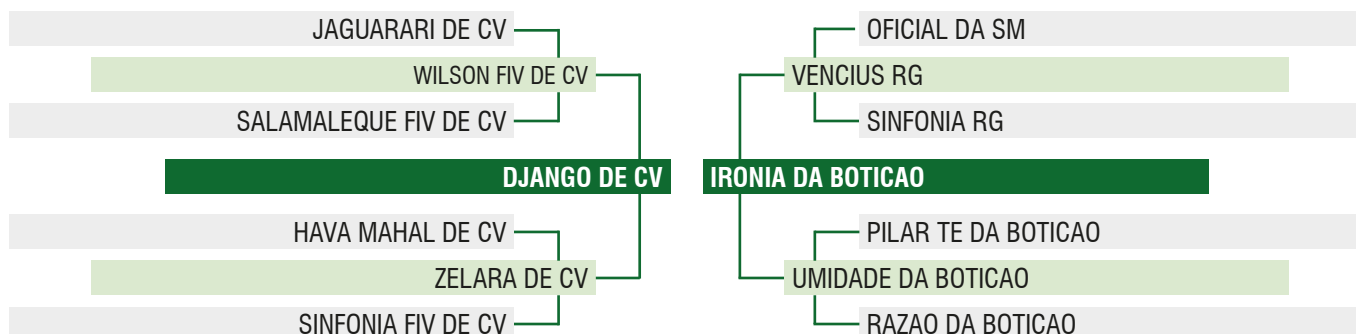
 MACHO • NELORE MOCHO PO • BOM 3416 • 30/09/2020
 PESO: **610** kg • PE: **33** cm

	MGTe	MP120	MP210	DP210	DP365	DP450	DPE365	DPE450	DAOL	DACAB	DIPP	DSTAY	D3P
DEP	15.06	0.77	1.13	6.75	11.82	12.40	0.25	-0.07	0.62	0.39	-0.77	78.05	81.28
TOP	19%	52%	51%	24%	27%	27%	39%	67%	21%	16%	27%	20%	29%

	iABCZ	PD-ED	PA-ED	PS-ED	PM-EM	TMD	IPP	STAY	PE-365	PE-450	E	P	M	AOL	ACAB
DEP	9.79	3.10	7.73	10.66	0.76	2.59	-20.36	31.46	0.184	0.353	0.688	3.085	2.524	1.013	1.385
DECA	2	3	2	2	4	3	1	4	4	3	4	1	1	3	1

LOTE
75
 BATERIA 07

 Vendedor: **BOTICÃO NELORE MOCHO**

MENESTREL DA BOTICAO

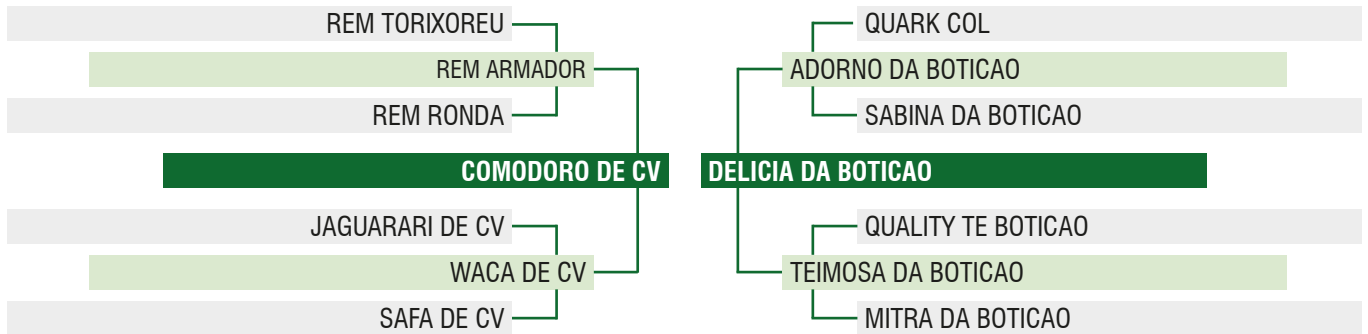
 MACHO • NELORE MOCHO PO • BOM 3417 • 30/09/2020
 PESO: **615** kg • PE: **33** cm

	MGTe	MP120	MP210	DP210	DP365	DP450	DPE365	DPE450	DAOL	DACAB	DIPP	DSTAY	D3P
DEP	15.21	3.58	4.77	8.62	13.55	11.16	0.33	0.19	1.62	0.19	-0.59	71.02	74.77
TOP	18%	5%	5%	15%	22%	32%	34%	45%	10%	29%	40%	30%	53%

	iABCZ	PD-ED	PA-ED	PS-ED	PM-EM	TMD	IPP	STAY	PE-365	PE-450	E	P	M	AOL	ACAB
DEP	10.90	6.51	8.28	9.85	2.02	5.50	-18.15	29.72	0.366	0.267	0.615	1.953	2.263	2.640	1.054
DECA	2	1	2	2	2	1	1	6	2	4	4	2	1	1	2

 LOTE
76
 BATERIA 08

 Vendedor: **BOTICÃO NELORE MOCHO**

MERIDIONAL DA BOTICAO

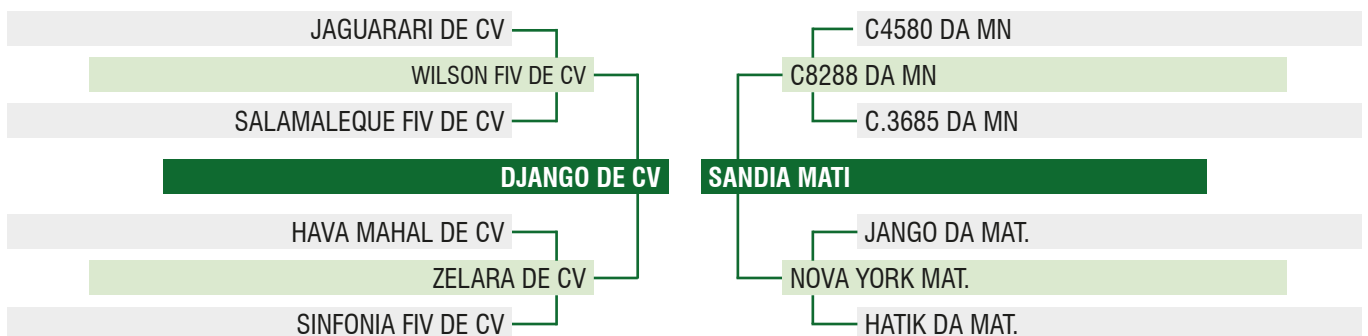
 MACHO • NELORE MOCHO PO • BOM 3419 • 01/10/2020
 PESO: **680** kg • PE: **34** cm

	MGTe	MP120	MP210	DP210	DP365	DP450	DPE365	DPE450	DAOL	DACAB	DIPP	DSTAY	D3P
DEP	17.56	1.19	1.49	6.91	13.74	15.40	0.16	-0.08	1.41	0.26	-0.84	84.84	83.28
TOP	13%	40%	44%	23%	21%	18%	46%	68%	11%	23%	22%	11%	22%

	iABCZ	PD-ED	PA-ED	PS-ED	PM-EM	TMD	IPP	STAY	PE-365	PE-450	E	P	M	AOL	ACAB
DEP	23.30	7.60	12.90	20.57	2.17	6.46	-37.09	39.18	0.428	0.834	0.239	4.943	3.795	2.787	3.240
DECA	1	1	1	1	1	1	1	1	2	1	6	1	1	1	1

LOTE
77
BATERIA 08

Vendedor: **BOTICÃO NELORE MOCHO**

MERCURIO DA BOTICAO

MACHO • NELORE MOCHO PO • BOM 3424 • 03/10/2020
PESO: **620** kg • PE: **36** cm

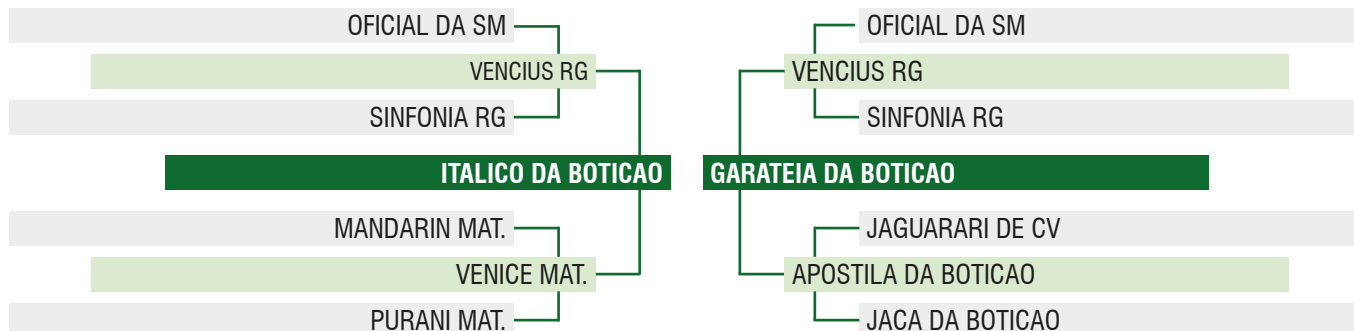

	MGTe	MP120	MP210	DP210	DP365	DP450	DPE365	DPE450	DAOL	DACAB	DIPP	DSTAY	D3P
DEP	14.11	0.14	0.09	9.49	11.06	12.95	0.17	0.31	-1.43	0.22	-0.80	77.19	80.61
TOP	21%	70%	73%	12%	30%	25%	45%	38%	84%	27%	25%	22%	32%

	iABCZ	PD-ED	PA-ED	PS-ED	PM-EM	TMD	IPP	STAY	PE-365	PE-450	E	P	M	AOL	ACAB
DEP	5.85	4.23	8.16	10.50	0.41	1.88	-0.87	29.79	0.128	0.186	3.089	2.611	3.115	-0.634	0.074
DECA	3	2	2	2	5	4	6	6	5	5	1	1	1	8	5

LOTE
78
BATERIA 08

Vendedor: **BOTICÃO NELORE MOCHO**

MISTER DA BOTICAO

MACHO • NELORE MOCHO PO • BOM 3455 • 08/11/2020
PESO: **600** kg • PE: **36** cm

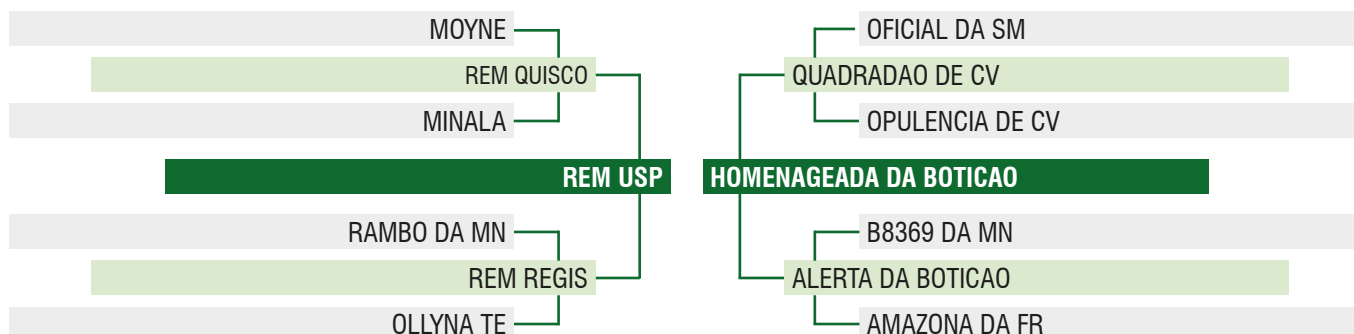

	MGTe	MP120	MP210	DP210	DP365	DP450	DPE365	DPE450	DAOL	DACAB	DIPP	DSTAY	D3P
DEP	16.24	2.45	3.00	9.94	13.22	17.11	0.66	0.51	-0.60	0.25	-0.58	75.36	77.93
TOP	16%	14%	18%	11%	23%	14%	18%	28%	56%	24%	41%	24%	42%

	iABCZ	PD-ED	PA-ED	PS-ED	PM-EM	TMD	IPP	STAY	PE-365	PE-450	E	P	M	AOL	ACAB
DEP	15.42	5.80	11.20	16.09	3.18	6.81	-11.08	35.01	0.397	0.713	0.808	2.823	2.343	0.407	-0.583
DECA	1	1	1	1	1	1	2	1	2	2	3	1	1	5	8

LOTE
79
BATERIA 09

Vendedor: **BOTICÃO NELORE MOCHO**

MITO DA BOTICAO

MACHO • NELORE MOCHO PO • BOM 3479 • 20/11/2020
PESO: **660** kg • PE: **34** cm

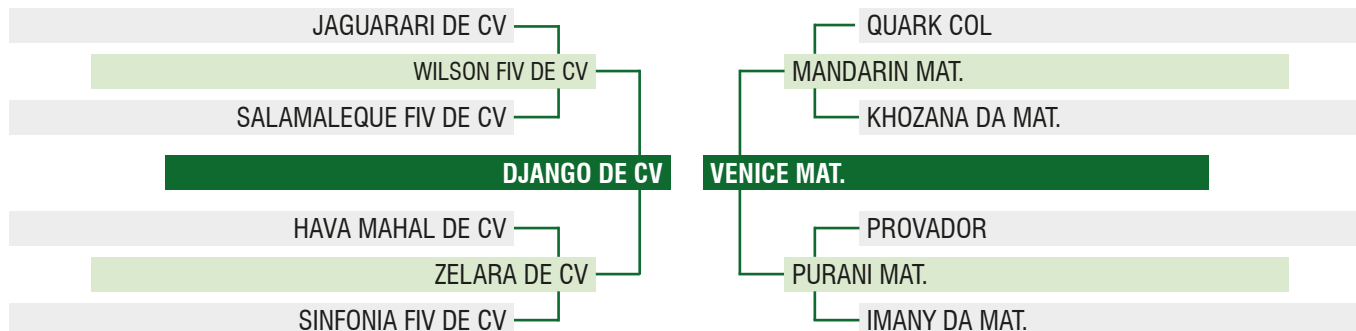

	MGTe	MP120	MP210	DP210	DP365	DP450	DPE365	DPE450	DAOL	DACAB	DIPP	DSTAY	D3P
DEP	20.80	1.66	2.30	9.78	19.17	18.52	0.68	0.59	3.07	0.32	-1.13	80.04	87.14
TOP	7%	29%	28%	11%	9%	12%	17%	25%	3%	19%	8%	18%	9%

	iABCZ	PD-ED	PA-ED	PS-ED	PM-EM	TMD	IPP	STAY	PE-365	PE-450	E	P	M	AOL	ACAB
DEP	12.16	6.06	8.43	9.78	0.67	4.02	-25.22	30.90	0.691	1.143	-0.027	4.918	2.996	2.591	1.887
DECA	1	1	1	2	4	2	1	5	1	1	7	1	1	1	1

LOTE
80
BATERIA 09

Vendedor: **BOTICÃO NELORE MOCHO**

MOSQUETE DA BOTICAO

MACHO • NELORE MOCHO PO • BOM 3452 • 05/11/2020
PESO: **600** kg • PE: **35** cm

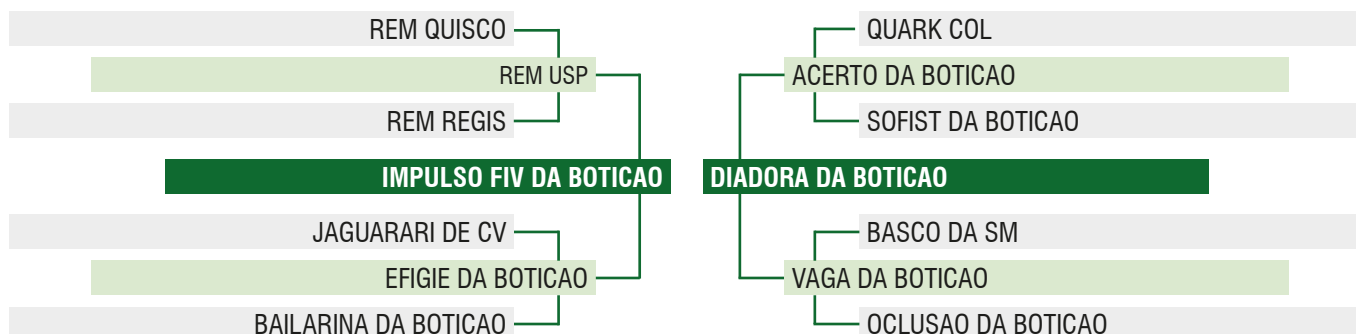

	MGTe	MP120	MP210	DP210	DP365	DP450	DPE365	DPE450	DAOL	DACAB	DIPP	DSTAY	D3P
DEP	16.35	2.22	2.89	7.97	13.57	15.69	0.55	0.97	1.41	0.29	-0.73	76.69	75.62
TOP	16%	18%	19%	18%	22%	18%	22%	14%	11%	21%	30%	22%	51%

	iABCZ	PD-ED	PA-ED	PS-ED	PM-EM	TMD	IPP	STAY	PE-365	PE-450	E	P	M	AOL	ACAB
DEP	14.22	9.42	11.52	17.16	2.30	6.86	-8.90	31.53	0.450	0.687	0.269	2.651	2.135	2.678	0.011
DECA	1	1	1	1	1	1	3	4	2	2	5	1	1	1	5

LOTE
84
INDIVIDUAL

Vendedor: **BOTICÃO NELORE MOCHO**

MERLIM DA BOTICAO

MACHO • NELORE MOCHO PO • BOM 3422 • 01/10/2020
PESO: **710** kg • PE: **35** cm

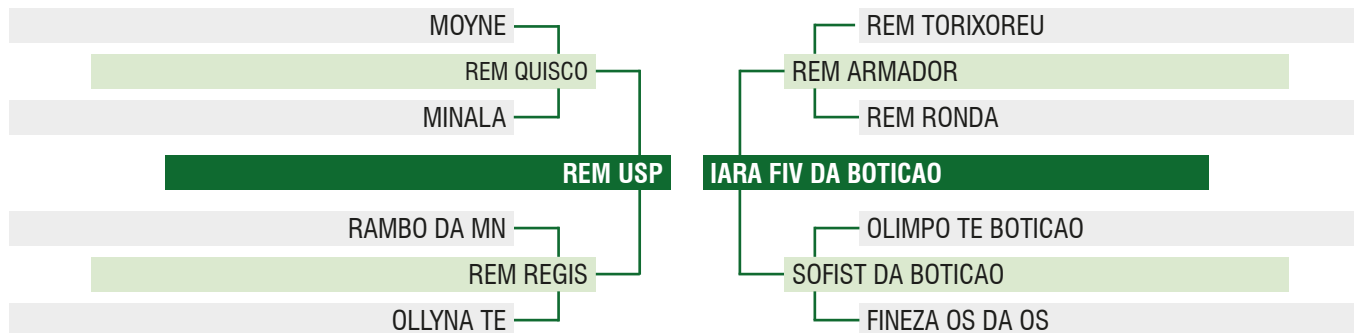

	MGTe	MP120	MP210	DP210	DP365	DP450	DPE365	DPE450	DAOL	DACAB	DIPP	DSTAY	D3P
DEP	18.52	1.96	2.53	9.17	15.23	13.46	0.77	1.08	1.14	0.44	-0.86	86.66	79.31
TOP	11%	22%	24%	13%	17%	24%	15%	11%	14%	13%	21%	8%	37%

	iABCZ	PD-ED	PA-ED	PS-ED	PM-EM	TMD	IPP	STAY	PE-365	PE-450	E	P	M	AOL	ACAB
DEP	18.72	8.26	11.83	15.92	1.96	6.61	-12.60	38.59	0.766	1.131	0.430	4.249	3.941	1.369	0.582
DECA	1	1	1	1	2	1	2	1	1	1	5	1	1	2	3

LOTE
85
INDIVIDUAL

Vendedor: **BOTICÃO NELORE MOCHO**

MARECHAL DA BOTICAO

MACHO • NELORE MOCHO PO • BOM 3385 • 16/09/2020
PESO: **680** kg • PE: **35** cm

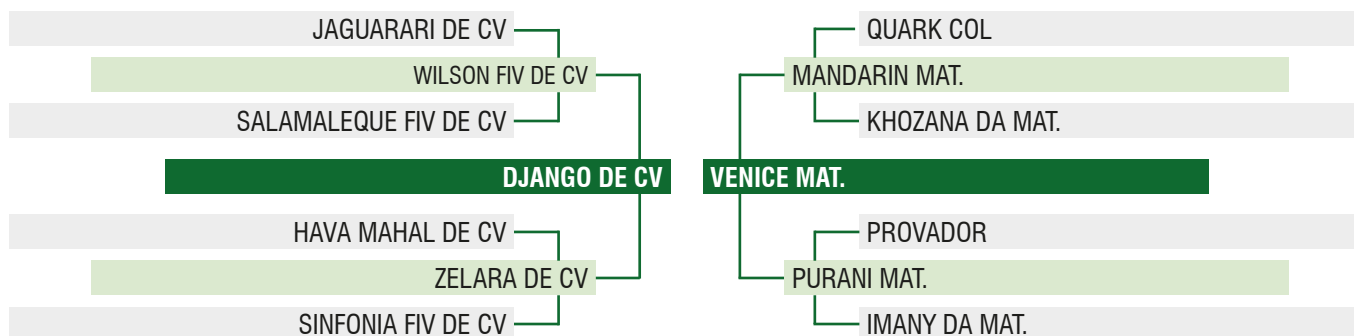

	MGTe	MP120	MP210	DP210	DP365	DP450	DPE365	DPE450	DAOL	DACAB	DIPP	DSTAY	D3P
DEP	18.33	0.76	1.09	6.50	14.54	14.93	0.56	0.53	1.07	0.45	-1.19	85.15	89.60
TOP	11%	52%	52%	26%	19%	20%	22%	28%	15%	13%	6%	10%	4%

	iABCZ	PD-ED	PA-ED	PS-ED	PM-EM	TMD	IPP	STAY	PE-365	PE-450	E	P	M	AOL	ACAB
DEP	15.52	5.42	8.99	12.60	2.01	5.41	-22.47	35.78	0.357	0.814	0.765	4.421	3.148	2.338	2.150
DECA	1	2	1	1	2	1	1	1	3	1	4	1	1	1	1

LOTE
86
INDIVIDUAL

Vendedor: **BOTICÃO NELORE MOCHO**

MARACANA DA BOTICAO

MACHO • NELORE MOCHO PO • BOM 3350 • 03/08/2020
PESO: **725** kg • PE: **38** cm

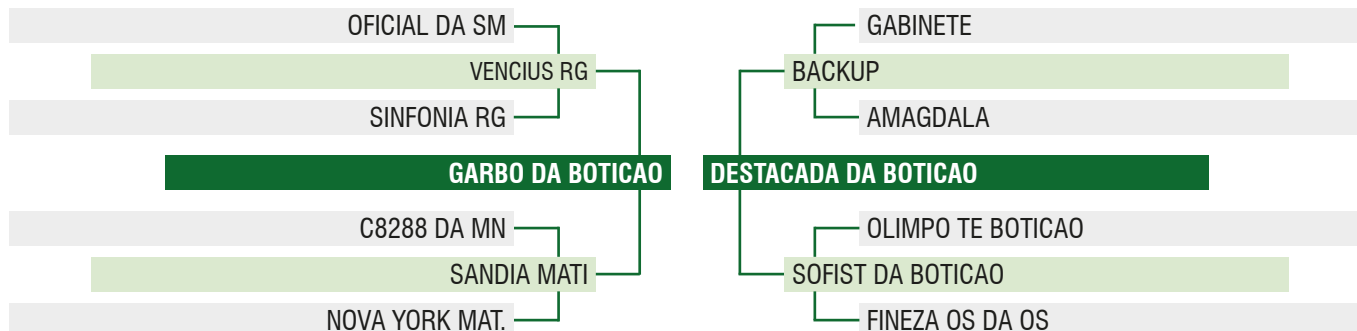

	MGTe	MP120	MP210	DP210	DP365	DP450	DPE365	DPE450	DAOL	DACAB	DIPP	DSTAY	D3P
DEP	15.37	-0.28	-0.47	8.98	23.04	20.90	0.07	0.07	-0.59	0.07	-0.85	77.83	78.65
TOP	18%	81%	83%	14%	5%	8%	54%	53%	56%	44%	22%	21%	39%

	iABCZ	PD-ED	PA-ED	PS-ED	PM-EM	TMD	IPP	STAY	PE-365	PE-450	E	P	M	AOL	ACAB
DEP	14.67	7.67	12.22	15.72	-0.02	3.83	-13.19	35.68	0.208	0.419	1.267	1.858	2.748	0.908	1.421
DECA	1	1	1	1	6	2	2	1	4	3	2	2	1	3	1

LOTE
87
INDIVIDUAL

Vendedor: **BOTICÃO NELORE MOCHO**

MURAL DA BOTICAO

MACHO • NELORE MOCHO PO • BOM 3460 • 10/11/2020
PESO: **730** kg • PE: **41** cm

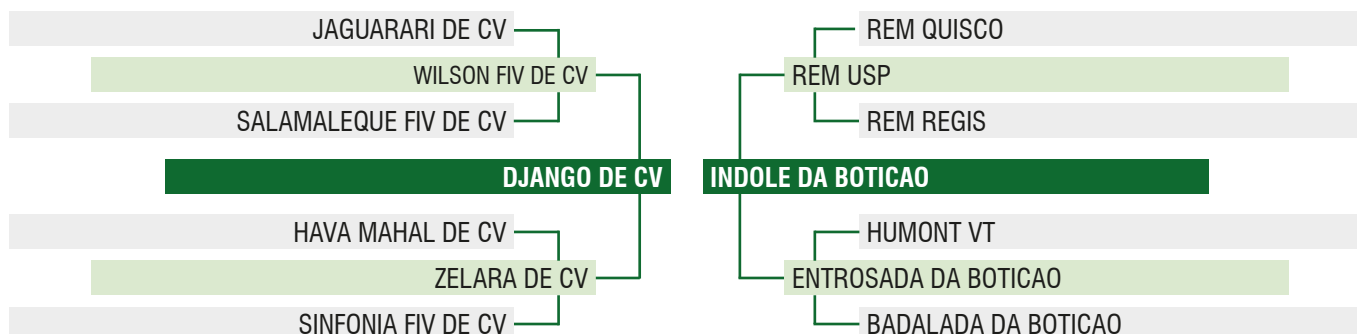

	MGTe	MP120	MP210	DP210	DP365	DP450	DPE365	DPE450	DAOL	DACAB	DIPP	DSTAY	D3P
DEP	25.28	3.67	4.89	14.70	26.38	25.89	1.45	2.09	2.54	0.52	-1.01	82.93	84.50
TOP	2%	4%	4%	3%	3%	3%	3%	1%	4%	10%	13%	14%	17%

	iABCZ	PD-ED	PA-ED	PS-ED	PM-EM	TMD	IPP	STAY	PE-365	PE-450	E	P	M	AOL	ACAB
DEP	24.84	9.73	14.77	19.50	3.06	8.47	-34.70	38.53	0.887	1.885	1.476	3.596	2.271	2.658	2.398
DECA	1	1	1	1	1	1	1	1	1	1	2	1	1	1	1

LOTE
88
INDIVIDUAL

Vendedor: **BOTICÃO NELORE MOCHO**

MANAÇA DA BOTICAO

MACHO • NELORE MOCHO PO • BOM 3423 • 03/10/2020
PESO: **700** kg • PE: **34** cm

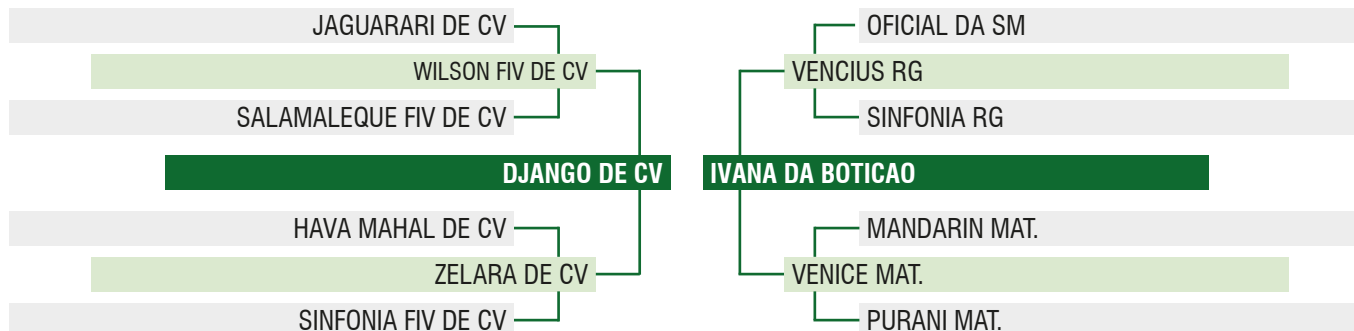

	MGTe	MP120	MP210	DP210	DP365	DP450	DPE365	DPE450	DAOL	DACAB	DIPP	DSTAY	D3P
DEP	19.87	-0.06	0.09	10.71	19.07	18.89	0.41	0.30	1.24	0.63	-0.91	85.77	84.46
TOP	8%	76%	73%	9%	9%	11%	29%	38%	13%	7%	18%	9%	18%

	iABCZ	PD-ED	PA-ED	PS-ED	PM-EM	TMD	IPP	STAY	PE-365	PE-450	E	P	M	AOL	ACAB
DEP	16.26	8.53	11.35	15.04	1.75	6.54	-22.14	33.50	0.373	0.662	0.998	4.027	3.193	1.509	1.728
DECA	1	1	1	1	2	1	1	2	2	2	3	1	1	2	1

LOTE
89
BATERIA 10

Vendedor: **NELORE MOCHO RANCHINHO**

2860 ALMB

FÊMEA • NELORE MOCHO PO • ALMB 2860 • 08/08/2021
PESO: **375** kg

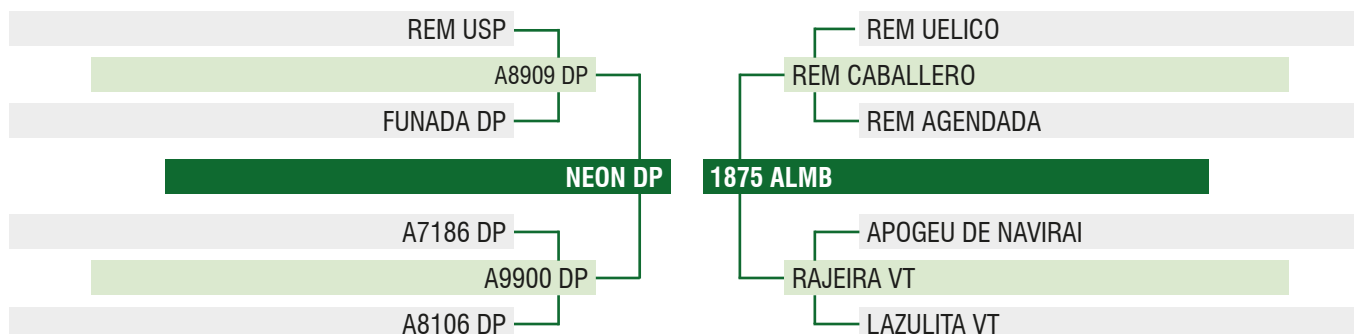

	MGTe	MP120	MP210	DP210	DP365	DP450	DPE365	DPE450	DAOL	DACAB	DIPP	DSTAY	D3P
DEP	20.15	2.07	2.67	11.58	18.95	17.95	0.96	1.25	2.23	0.25	-0.96	80.03	80.36
TOP	8%	20%	22%	7%	10%	13%	10%	8%	6%	25%	15%	18%	32%

	iABCZ	PD-ED	PA-ED	PS-ED	PM-EM	TMD	IPP	STAY	PE-365	PE-450	E	P	M	AOL	ACAB
DEP	16.18	9.10	11.20	12.67	2.48	7.85	-13.49	34.17	0.768	0.815	1.918	2.972	3.119	2.453	0.203
DECA	1	1	1	1	1	1	2	2	1	1	1	1	1	1	4

LOTE
92
 BATERIA 10

Vendedor: NELORE MOCHO RANCHINHO

2915 ALMB

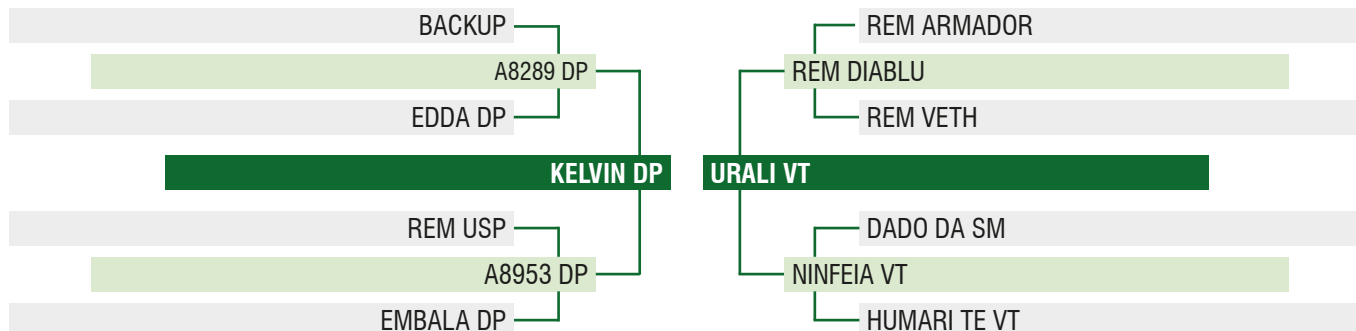
 FÊMEA • NELORE MOCHO PO • ALMB 2915 • 18/08/2021
 PESO: **385** kg

	MGTe	MP120	MP210	DP210	DP365	DP450	DPE365	DPE450	DAOL	DACAB	DIPP	DSTAY	D3P
DEP	17.10	1.06	1.37	9.86	16.22	16.44	0.83	0.83	1.49	0.25	-0.74	80.05	72.73
TOP	14%	43%	45%	11%	15%	16%	13%	18%	11%	25%	29%	18%	60%

	iABCZ	PD-ED	PA-ED	PS-ED	PM-EM	TMD	IPP	STAY	PE-365	PE-450	E	P	M	AOL	ACAB
DEP	16.16	6.13	8.42	15.13	1.49	3.63	-12.92	38.63	0.613	0.816	1.481	3.115	1.804	2.330	0.399
DECA	1	1	1	1	2	2	2	1	1	1	2	1	2	1	4

 LOTE
93
 BATERIA 10

Vendedor: NELORE MOCHO RANCHINHO

3126 ALMB

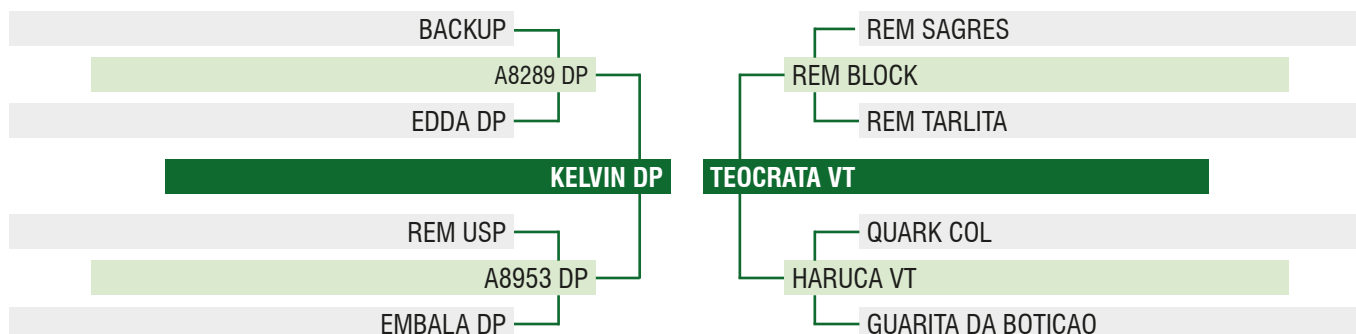
 FÊMEA • NELORE MOCHO PO • ALMB 3126 • 12/11/2021
 PESO: **367** kg

	MGTe	MP120	MP210	DP210	DP365	DP450	DPE365	DPE450	DAOL	DACAB	DIPP	DSTAY	D3P
DEP	14.77	0.83	1.02	9.82	16.35	15.21	0.59	0.53	0.42	0.22	-0.55	77.59	68.1
TOP	19%	49%	53%	11%	15%	19%	21%	28%	24%	27%	43%	22%	73%

	iABCZ	PD-ED	PA-ED	PS-ED	PM-EM	TMD	IPP	STAY	PE-365	PE-450	E	P	M	AOL	ACAB
DEP	14.91	6.52	10.43	14.06	1.23	3.97	-10.19	37.35	0.390	0.568	1.194	2.725	2.055	1.165	0.347
DECA	1	1	1	1	3	2	2	1	2	2	2	1	2	2	4

LOTE
94
 BATERIA 10

Vendedor: NELORE MOCHO RANCHINHO

2875 ALMB

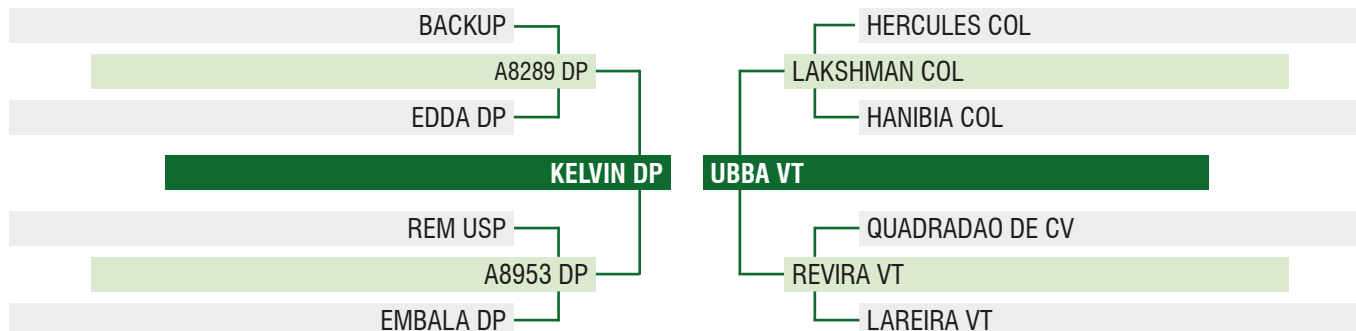
 FÊMEA • NELORE MOCHO PO • ALMB 2875 • 11/08/2021
 PESO: 396 kg

	MGTe	MP120	MP210	DP210	DP365	DP450	DPE365	DPE450	DAOL	DACAB	DIPP	DSTAY	D3P
DEP	14.64	0.06	-0.15	10.24	14.86	16.2	0.56	0.6	0.74	0.17	-0.54	75.87	67.83
TOP	20%	71%	77%	10%	18%	16%	22%	25%	19%	32%	44%	24%	74%

	iABCZ	PD-ED	PA-ED	PS-ED	PM-EM	TMD	IPP	STAY	PE-365	PE-450	E	P	M	AOL	ACAB
DEP	12.27	5.65	8.33	12.67	0.17	2.31	-9.76	36.01	0.378	0.532	0.912	2.766	2.017	1.177	0.605
DECA	1	2	2	1	5	4	3	1	2	2	3	1	2	2	3

 LOTE
95
 BATERIA 10

Vendedor: NELORE MOCHO RANCHINHO

2962 ALMB

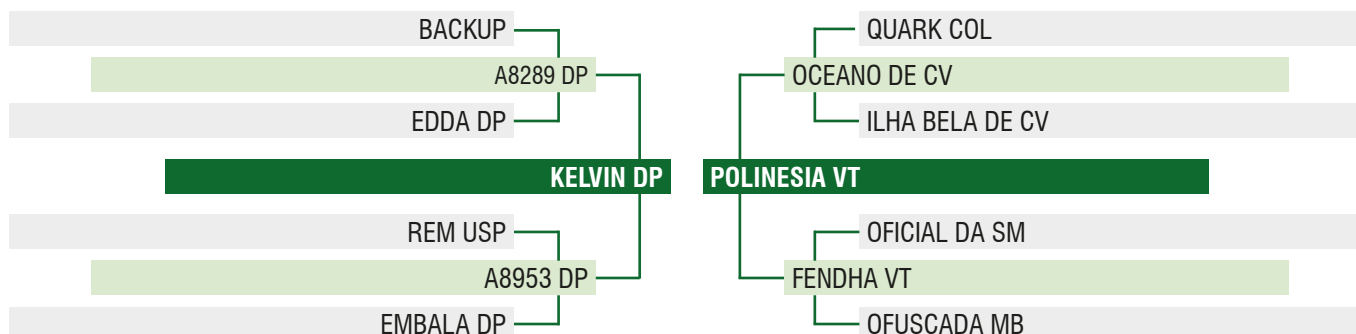
 FÊMEA • NELORE MOCHO PO • ALMB 2962 • 07/09/2021
 PESO: 371 kg

	MGTe	MP120	MP210	DP210	DP365	DP450	DPE365	DPE450	DAOL	DACAB	DIPP	DSTAY	D3P
DEP	13.77	1.15	1.44	7.96	13.3	10.03	0.49	0.28	0.42	0.25	-0.56	78.49	71.1
TOP	22%	41%	44%	18%	23%	36%	25%	40%	24%	25%	42%	20%	65%

	iABCZ	PD-ED	PA-ED	PS-ED	PM-EM	TMD	IPP	STAY	PE-365	PE-450	E	P	M	AOL	ACAB
DEP	11.28	5.44	5.60	8.26	1.29	2.99	-7.76	36.55	0.315	0.248	0.918	2.390	1.514	0.683	0.616
DECA	2	2	3	2	3	3	3	1	3	4	3	2	2	4	3

LOTE
96
DUPLO

Vendedor: **NELORE MOCHO RANCHINHO**

2949 ALMB

FÊMEA • NELORE MOCHO PO • ALMB 2949 • 02/09/2021
PESO: **382** kg

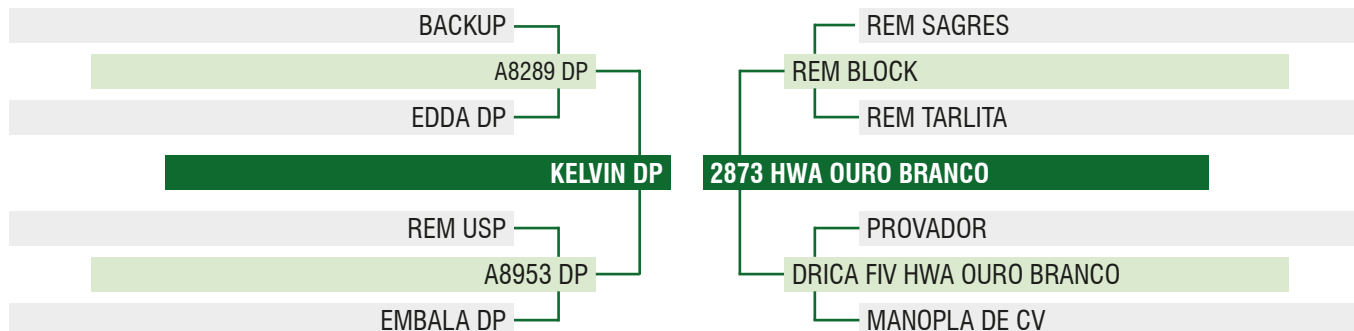

	MGTe	MP120	MP210	DP210	DP365	DP450	DPE365	DPE450	DAOL	DACAB	DIPP	DSTAY	D3P
DEP	15.23	0.02	-0.04	9.52	18.86	15.23	0.58	0.61	0.23	0.29	-0.79	80.95	71.15
TOP	18%	72%	75%	12%	10%	19%	21%	25%	28%	22%	25%	17%	65%

	iABCZ	PD-ED	PA-ED	PS-ED	PM-EM	TMD	IPP	STAY	PE-365	PE-450	E	P	M	AOL	ACAB
DEP	16.66	6.13	10.12	17.98	0.80	3.04	-12.83	39.28	0.347	0.571	1.616	2.827	1.939	1.422	0.429
DECA	1	1	1	1	4	3	2	1	3	2	1	1	2	2	4

3059 ALMB

FÊMEA • NELORE MOCHO PO • ALMB 3059 • 14/10/2021
PESO: **396** kg

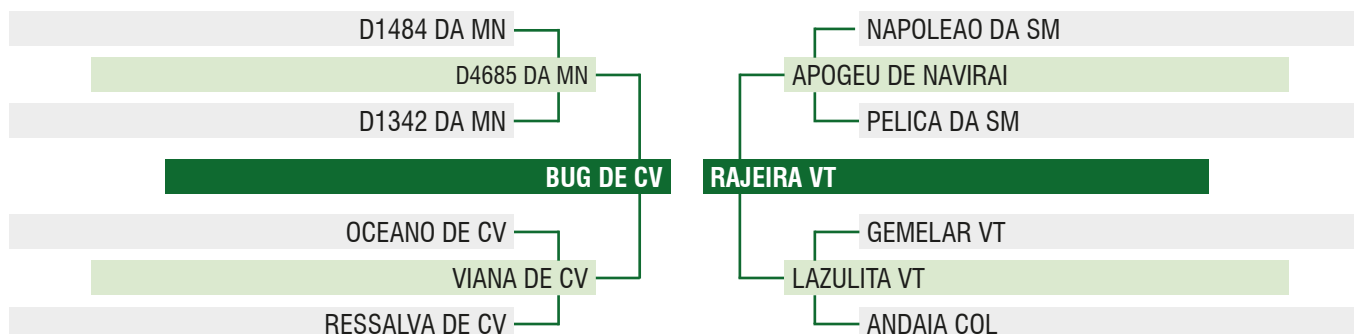

	MGTe	MP120	MP210	DP210	DP365	DP450	DPE365	DPE450	DAOL	DACAB	DIPP	DSTAY	D3P
DEP	16.07	3.29	4.19	8.07	18.15	19.1	0.83	0.97	-0.29	0.29	-0.92	70.72	79.35
TOP	16%	6%	7%	18%	11%	11%	13%	14%	46%	22%	18%	31%	36%

	iABCZ	PD-ED	PA-ED	PS-ED	PM-EM	TMD	IPP	STAY	PE-365	PE-450	E	P	M	AOL	ACAB
DEP	14.14	4.66	8.88	12.40	4.23	6.95	-12.37	33.78	0.690	0.952	1.488	1.567	1.484	0.837	0.597
DECA	1	2	1	1	1	1	2	2	1	1	2	3	2	3	3

LOTE
97
TRIPL0

Vendedor: **NELORE MOCHO RANCHINHO**

3032 ALMB

FÊMEA • NELORE MOCHO PO • ALMB 3032 • 05/10/2021 • PESO: **365** kg

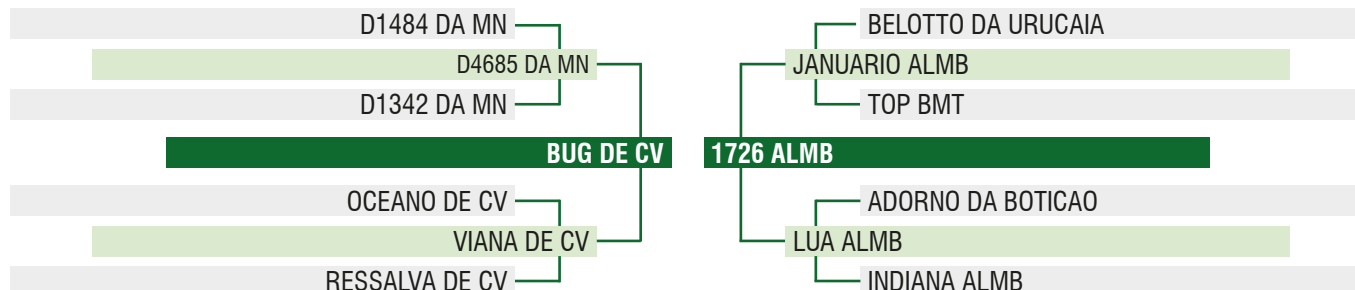

	MGTe	MP120	MP210	DP210	DP365	DP450	DPE365	DPE450	DAOL	DACAB	DIPP	DSTAY	D3P
DEP	15.73	4.09	5.3	9.79	20.99	19.02	0.8	0.87	-0.01	0.46	-0.7	61.73	77.94
TOP	17%	3%	3%	11%	7%	11%	14%	17%	36%	13%	32%	50%	41%

	iABCZ	PD-ED	PA-ED	PS-ED	PM-EM	TMD	IPP	STAY	PE-365	PE-450	E	P	M	AOL	ACAB
DEP	15.00	6.50	10.70	14.21	3.95	8.00	-13.32	32.53	0.684	0.932	1.861	1.754	2.004	1.031	0.638
DECA	1	1	1	1	1	1	2	3	1	1	1	2	2	3	3

3114 ALMB

FÊMEA • NELORE MOCHO PO • ALMB 3114 • 08/11/2021 • PESO: **398** kg

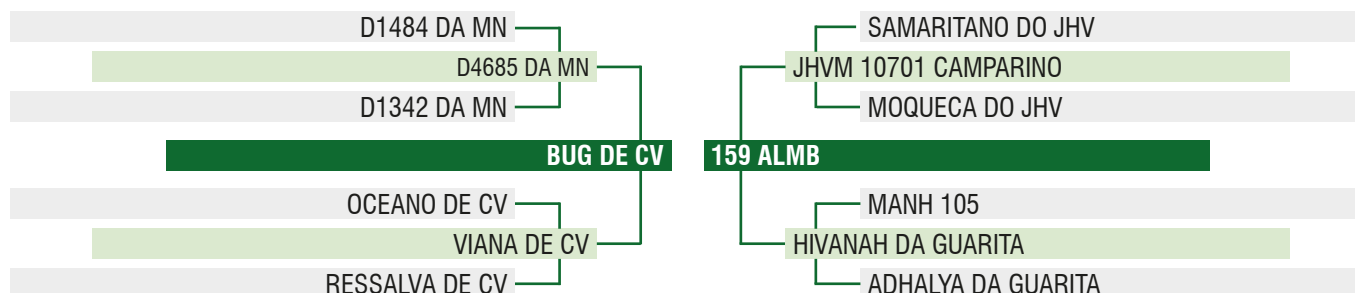

	MGTe	MP120	MP210	DP210	DP365	DP450	DPE365	DPE450	DAOL	DACAB	DIPP	DSTAY	D3P
DEP	14.57	3.05	4.1	8.85	17.84	18.93	1.01	1.08	-1.15	0.4	-0.77	64.66	76.96
TOP	20%	8%	8%	14%	12%	11%	9%	12%	75%	15%	27%	43%	45%

	iABCZ	PD-ED	PA-ED	PS-ED	PM-EM	TMD	IPP	STAY	PE-365	PE-450	E	P	M	AOL	ACAB
DEP	14.90	5.72	10.83	15.62	3.84	7.67	-8.93	33.11	0.871	1.204	2.041	1.673	1.794	0.243	0.613
DECA	1	2	1	1	1	1	3	3	1	1	1	2	2	5	3

3174 ALMB

FÊMEA • NELORE MOCHO PO • ALMB 3174 • 30/11/2021 • PESO: **360** kg

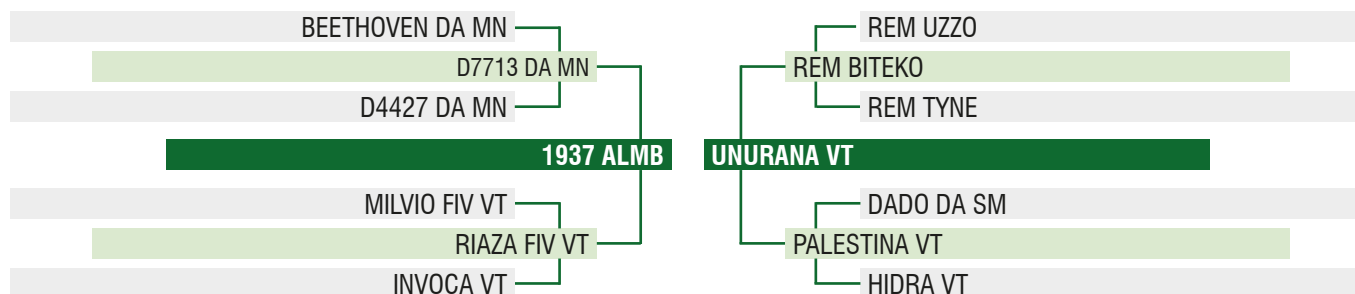

	MGTe	MP120	MP210	DP210	DP365	DP450	DPE365	DPE450	DAOL	DACAB	DIPP	DSTAY	D3P
DEP	15.32	2.74	3.36	6.86	18.14	14.33	0.61	0.95	0.23	0	-0.85	77.9	77.43
TOP	18%	11%	13%	24%	11%	21%	20%	14%	28%	57%	22%	21%	43%

	iABCZ	PD-ED	PA-ED	PS-ED	PM-EM	TMD	IPP	STAY	PE-365	PE-450	E	P	M	AOL	ACAB
DEP	18.71	6.99	12.89	18.83	2.50	7.05	-22.04	34.64	0.932	1.051	0.357	3.694	1.683	1.496	1.146
DECA	1	1	1	1	1	1	1	2	1	1	5	1	2	2	1

LOTE
98
 BATERIA 11

Vendedor: **NELORE MOCHO RANCHINHO**

3095 ALMB

FÊMEA • NELORE MOCHO PO • ALMB 3095 • 04/11/2021
 PESO: **382** kg

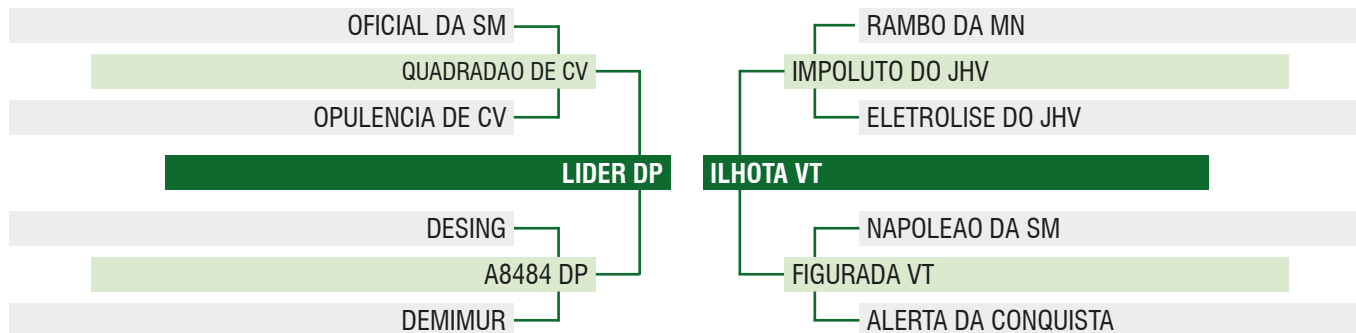

	MGTe	MP120	MP210	DP210	DP365	DP450	DPE365	DPE450	DAOL	DACAB	DIPP	DSTAY	D3P
DEP	18.35	1.05	1.32	12.09	24.7	22.58	0.78	1.2	1.89	0.13	-0.88	70.93	76.84
TOP	11%	43%	46%	6%	4%	6%	15%	9%	8%	36%	20%	31%	46%

	iABCZ	PD-ED	PA-ED	PS-ED	PM-EM	TMD	IPP	STAY	PE-365	PE-450	E	P	M	AOL	ACAB
DEP	17.64	10.82	16.02	18.50	2.63	7.91	-15.73	31.51	0.769	1.030	2.346	2.319	2.036	2.779	1.287
DECA	1	1	1	1	1	1	1	4	1	1	1	2	2	1	1

LOTE
99
BATERIA 11

Vendedor: **NELORE MOCHO RANCHINHO**

3040 ALMB

FÊMEA • NELORE MOCHO PO • ALMB 3040 • 08/10/2021 • PESO: **364** kg

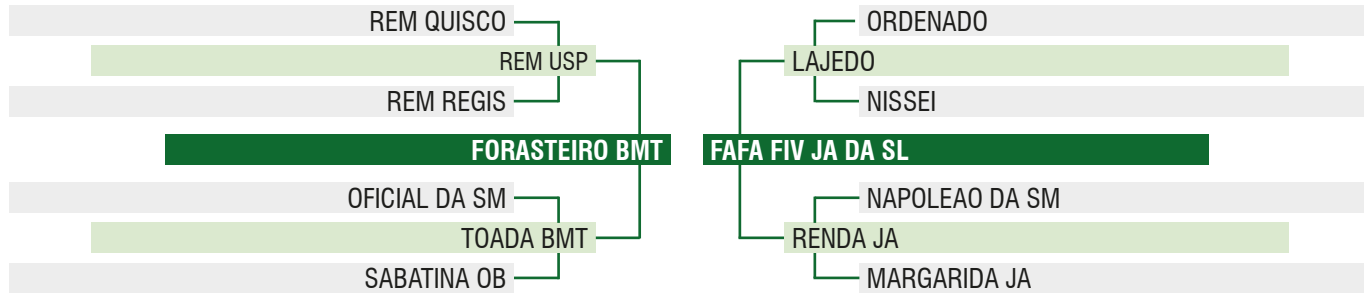

	MGTe	MP120	MP210	DP210	DP365	DP450	DPE365	DPE450	DAOL	DACAB	DIPP	DSTAY	D3P
DEP	10.24	2.4	3.21	4.36	10.8	9.43	0.41	0.45	-0.62	0.17	-0.62	71	67.66
TOP	34%	15%	15%	40%	31%	38%	29%	31%	57%	32%	37%	31%	74%

	iABCZ	PD-ED	PA-ED	PS-ED	PM-EM	TMD	IPP	STAY	PE-365	PE-450	E	P	M	AOL	ACAB
DEP	6.12	1.82	4.56	7.42	2.01	3.13	-2.77	31.58	0.189	0.210	0.995	2.552	1.770	0.518	-0.428
DECA	3	5	3	3	2	3	5	4	4	4	3	1	2	4	7

3083 ALMB

FÊMEA • NELORE MOCHO PO • ALMB 3083 • 01/11/2021 • PESO: **370** kg

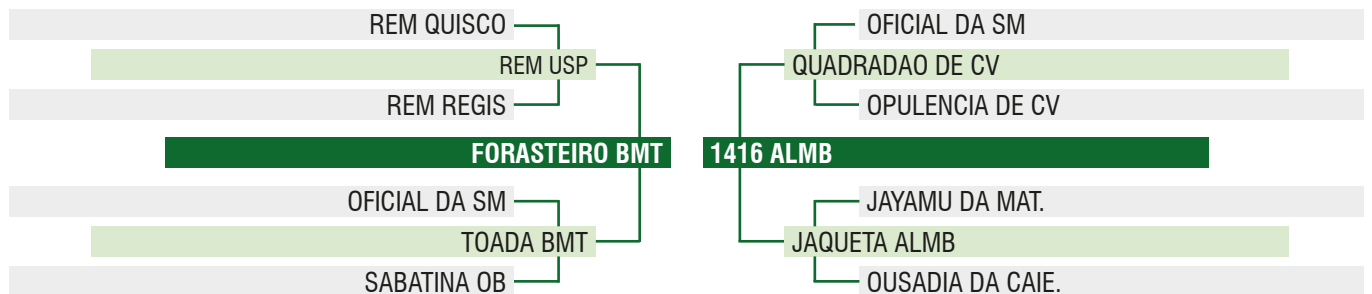

	MGTe	MP120	MP210	DP210	DP365	DP450	DPE365	DPE450	DAOL	DACAB	DIPP	DSTAY	D3P
DEP	11.46	2.04	2.42	5.64	9.36	9.8	0.61	0.81	-0.66	0.25	-0.66	69.28	73.79
TOP	30%	21%	26%	31%	37%	37%	20%	18%	58%	25%	34%	34%	57%

	iABCZ	PD-ED	PA-ED	PS-ED	PM-EM	TMD	IPP	STAY	PE-365	PE-450	E	P	M	AOL	ACAB
DEP	6.23	2.24	4.48	8.44	1.98	2.80	-8.98	29.18	0.452	0.687	1.124	2.919	2.518	0.371	-0.724
DECA	3	4	3	2	2	3	3	7	2	2	2	1	1	5	8

3102 ALMB

FÊMEA • NELORE MOCHO PO • ALMB 3102 • 05/11/2021 • PESO: **367** kg

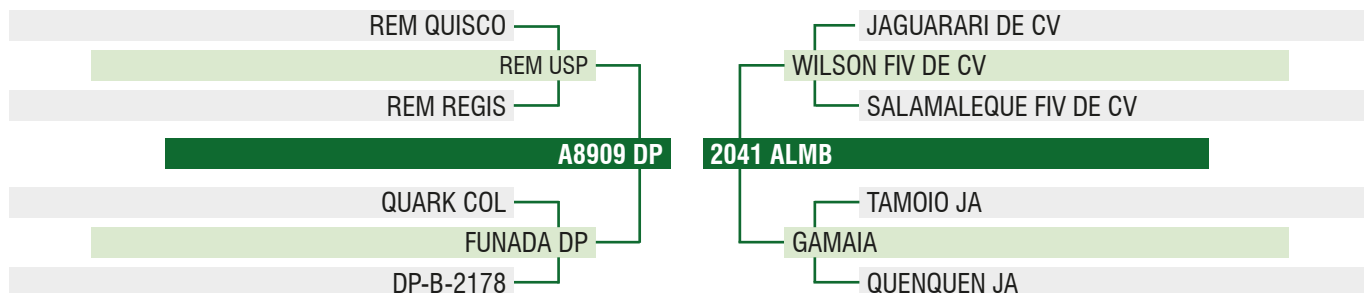

	MGTe	MP120	MP210	DP210	DP365	DP450	DPE365	DPE450	DAOL	DACAB	DIPP	DSTAY	D3P
DEP	13.38	-0.44	-0.44	8.8	12.95	13.33	0.65	0.77	-0.13	0.11	-0.57	75.01	72.93
TOP	23%	84%	82%	15%	24%	24%	19%	19%	41%	39%	41%	25%	59%

	iABCZ	PD-ED	PA-ED	PS-ED	PM-EM	TMD	IPP	STAY	PE-365	PE-450	E	P	M	AOL	ACAB
DEP	8.96	5.36	7.88	9.90	-0.87	1.66	-10.31	32.09	0.554	0.731	1.254	2.745	2.637	0.538	-0.236
DECA	2	2	2	2	8	4	2	4	1	2	2	1	1	4	6

LOTE
100
BATERIA 11

Vendedor: **NELORE MOCHO RANCHINHO**

3152 ALMB

FÊMEA • NELORE MOCHO PO • ALMB 3152 • 24/11/2021 • PESO: **320** kg

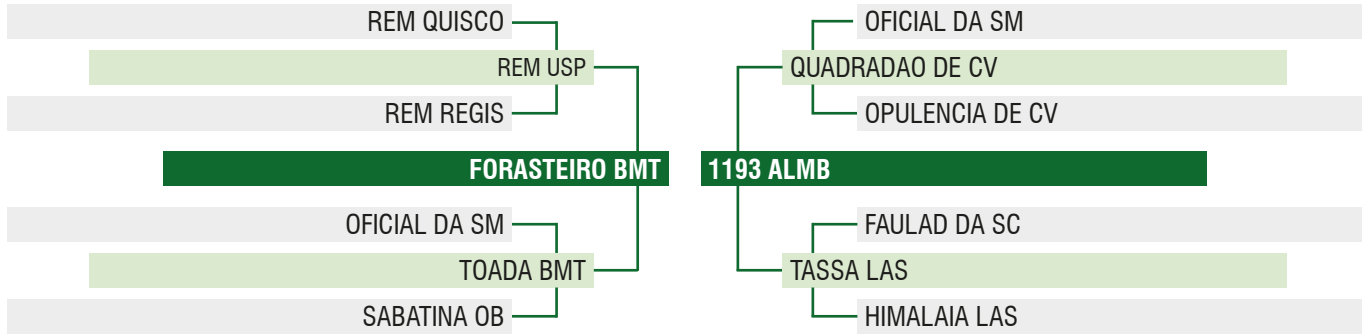

	MGTe	MP120	MP210	DP210	DP365	DP450	DPE365	DPE450	DAOL	DACAB	DIPP	DSTAY	D3P
DEP	12.32	2.84	3.52	3.99	6.27	9.49	0.62	0.58	-0.29	0.28	-0.73	74.76	74.28
TOP	27%	10%	12%	43%	51%	38%	20%	26%	46%	22%	29%	25%	55%

	iABCZ	PD-ED	PA-ED	PS-ED	PM-EM	TMD	IPP	STAY	PE-365	PE-450	E	P	M	AOL	ACAB
DEP	7.36	1.50	3.26	6.12	2.34	3.15	-9.83	32.07	0.445	0.444	1.223	2.904	2.163	0.616	-0.571
DECA	3	5	4	3	1	3	3	4	2	3	2	1	1	4	8

3163 ALMB

FÊMEA • NELORE MOCHO PO • ALMB 3163 • 26/11/2021 • PESO: **328** kg

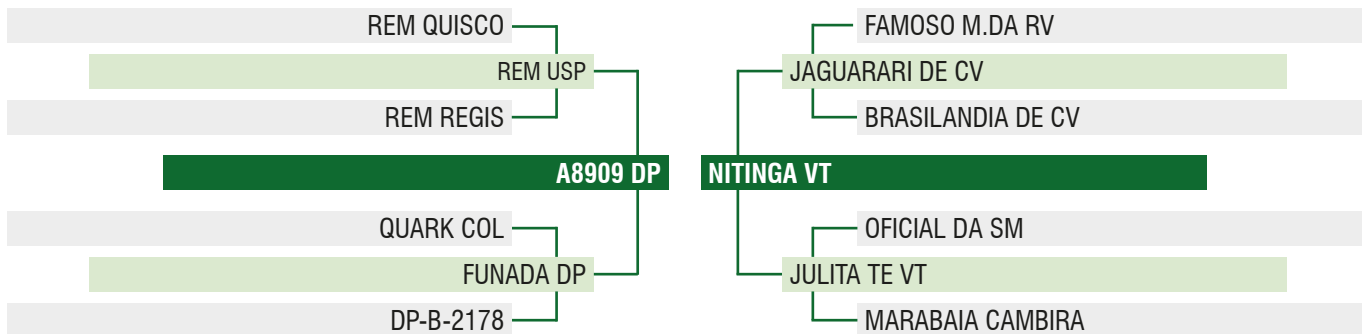

	MGTe	MP120	MP210	DP210	DP365	DP450	DPE365	DPE450	DAOL	DACAB	DIPP	DSTAY	D3P
DEP	12.26	1.04	1.43	6.07	11.27	13.26	0.45	0.55	0.14	-0.03	-0.52	71.65	72.65
TOP	27%	43%	44%	28%	30%	24%	27%	27%	30%	64%	45%	30%	60%

	iABCZ	PD-ED	PA-ED	PS-ED	PM-EM	TMD	IPP	STAY	PE-365	PE-450	E	P	M	AOL	ACAB
DEP	8.38	4.13	7.23	10.03	1.06	3.02	-6.97	31.17	0.506	0.766	1.560	2.539	2.401	0.908	-1.174
DECA	2	3	2	2	3	3	3	4	2	1	1	1	1	3	9

CONTINUAÇÃO DO LOTE

100
BATERIA 11

Vendedor: **NELORE MOCHO RANCHINHO**

3206 ALMB

FÊMEA • NELORE MOCHO PO • ALMB 3206 • 17/12/2021 • PESO: **320** kg

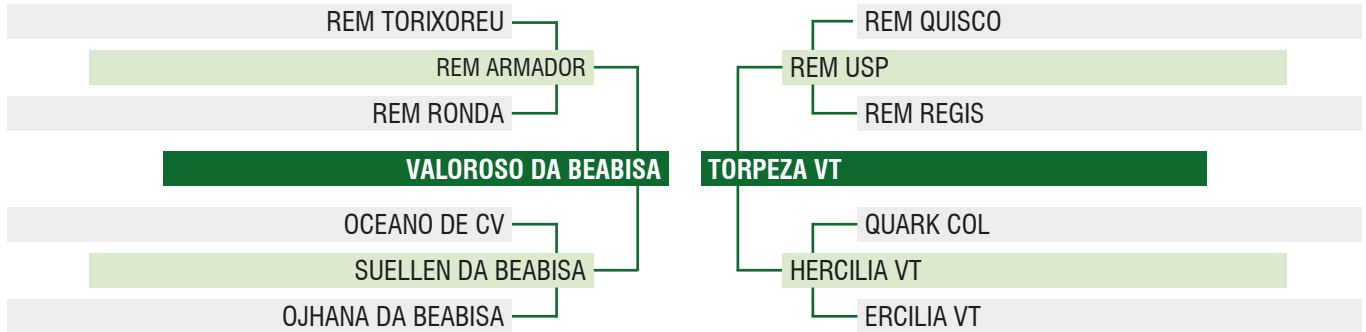

	MGTe	MP120	MP210	DP210	DP365	DP450	DPE365	DPE450	DAOL	DACAB	DIPP	DSTAY	D3P
DEP	16.69	3.07	4.07	6.74	13.59	16.22	0.75	0.94	0.9	0.12	-0.88	76.76	80.53
TOP	14%	8%	8%	24%	22%	16%	16%	15%	17%	37%	20%	23%	32%

	iABCZ	PD-ED	PA-ED	PS-ED	PM-EM	TMD	IPP	STAY	PE-365	PE-450	E	P	M	AOL	ACAB
DEP	16.09	5.58	9.39	11.37	3.70	7.39	-15.64	36.04	0.690	0.994	1.049	3.408	2.951	2.165	0.442
DECA	1	2	1	1	1	1	1	1	1	1	3	1	1	1	3

3210 ALMB

FÊMEA • NELORE MOCHO PO • ALMB 3210 • 19/12/2021 • PESO: **310** kg

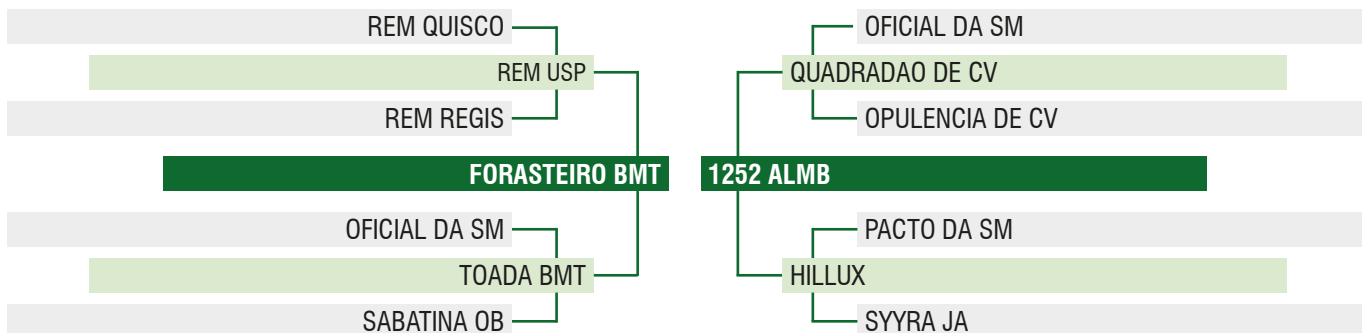

	MGTe	MP120	MP210	DP210	DP365	DP450	DPE365	DPE450	DAOL	DACAB	DIPP	DSTAY	D3P
DEP	10.16	2.41	3.05	2.2	6.85	9.94	0.54	0.88	-0.59	0.19	-0.61	70.71	71.58
TOP	35%	15%	17%	57%	48%	36%	23%	16%	56%	30%	38%	31%	64%

	iABCZ	PD-ED	PA-ED	PS-ED	PM-EM	TMD	IPP	STAY	PE-365	PE-450	E	P	M	AOL	ACAB
DEP	5.52	0.49	3.07	5.53	2.35	2.74	-6.12	30.99	0.414	0.536	1.127	2.415	1.921	0.244	-0.873
DECA	4	6	4	4	1	3	4	5	2	2	2	2	2	5	9